



US00D343127S

# United States Patent [19]

[11] Patent Number: **Des. 343,127**

Chen et al.

[45] Date of Patent: **\*\* Jan. 11, 1994**

[54] **COMBINED WRIST WATCH AND TIDE INDICATOR**

4,853,908 8/1989 Bourquin et al. .... D10/124 X  
4,881,213 11/1989 Zaslowsky ..... 368/15

[75] Inventors: **Li Chen; Pyn Maa**, both of Taipei, Taiwan

*Primary Examiner*—Nelson C. Holtje  
*Assistant Examiner*—Martie Thompson  
*Attorney, Agent, or Firm*—Baker, Maxham, Jester & Meador

[73] Assignee: **Xonix Electronic Watch Enterprise Co., Ltd.**, Taiwan

[\*\*] Term: **14 Years**

[57] **CLAIM**

[21] Appl. No.: **810,017**

The ornamental design for a combined wrist watch and tide indicator, as shown and described.

[22] Filed: **Dec. 17, 1991**

**DESCRIPTION**

[52] U.S. Cl. .... **D10/39; D10/126**

[58] Field of Search ..... 368/223-238, 276, 278, 280, 282, 285, 318, 322-323; D10/30-39, 122-126, 128, 129

FIG. 1 is a front plan view of a combined wrist watch and tide indicator showing our new design; FIG. 2 is a front elevational view with the time and moon indicators and bezel in alternate positions; FIG. 3 is a front elevational view with the time and moon indicators and bezel in further alternate positions; FIG. 4 is a perspective view thereof from the right side; FIG. 5 is a bottom plan view thereof; FIG. 6 is a left side elevation thereof; FIG. 7 is a right side elevation thereof; and, FIG. 8 is a top elevation thereof, the bottom elevation being a mirror image of the top elevation.

[56] **References Cited**

**U.S. PATENT DOCUMENTS**

D. 221,789	9/1971	Kolbreuer	.....	D10/39
D. 318,810	8/1991	Bourquin et al.	.....	D10/39
D. 319,028	8/1991	Bourquin et al.	.....	D10/39
D. 324,001	2/1992	Kerr	.....	D10/128
D. 333,101	2/1993	Krieger	.....	D10/39
3,183,659	5/1965	Etienne	.....	D10/126 X

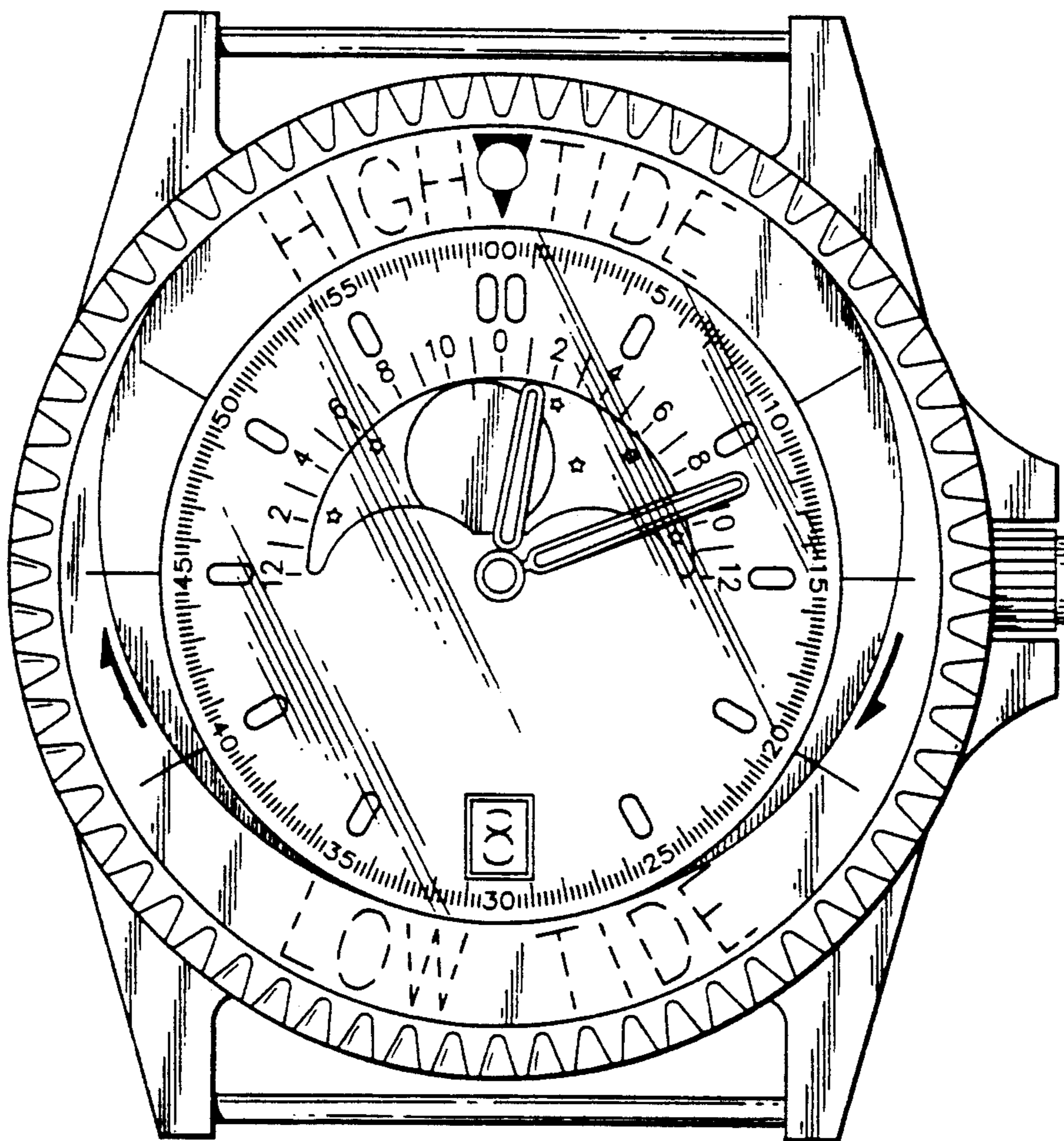

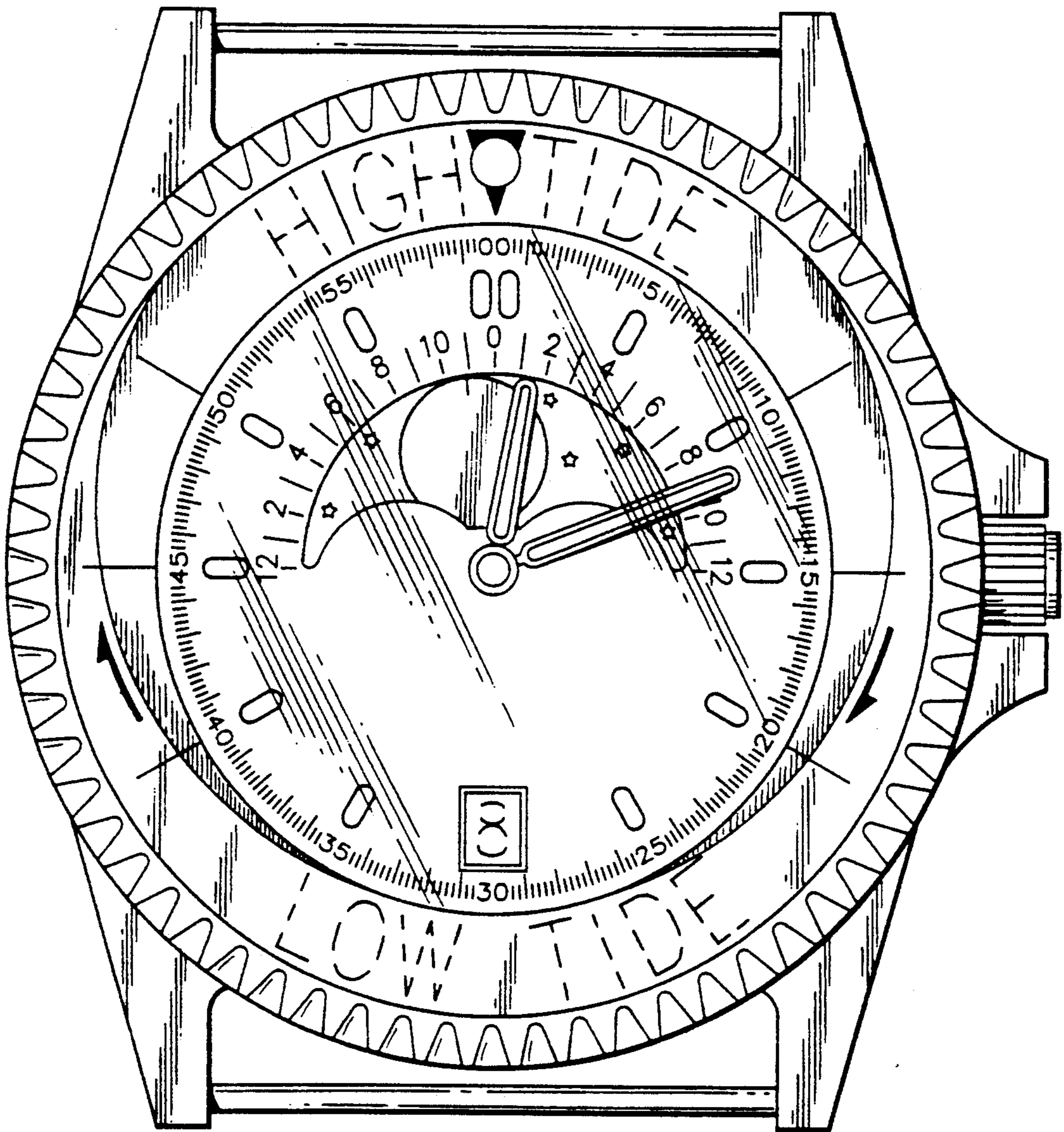

FIG. 1

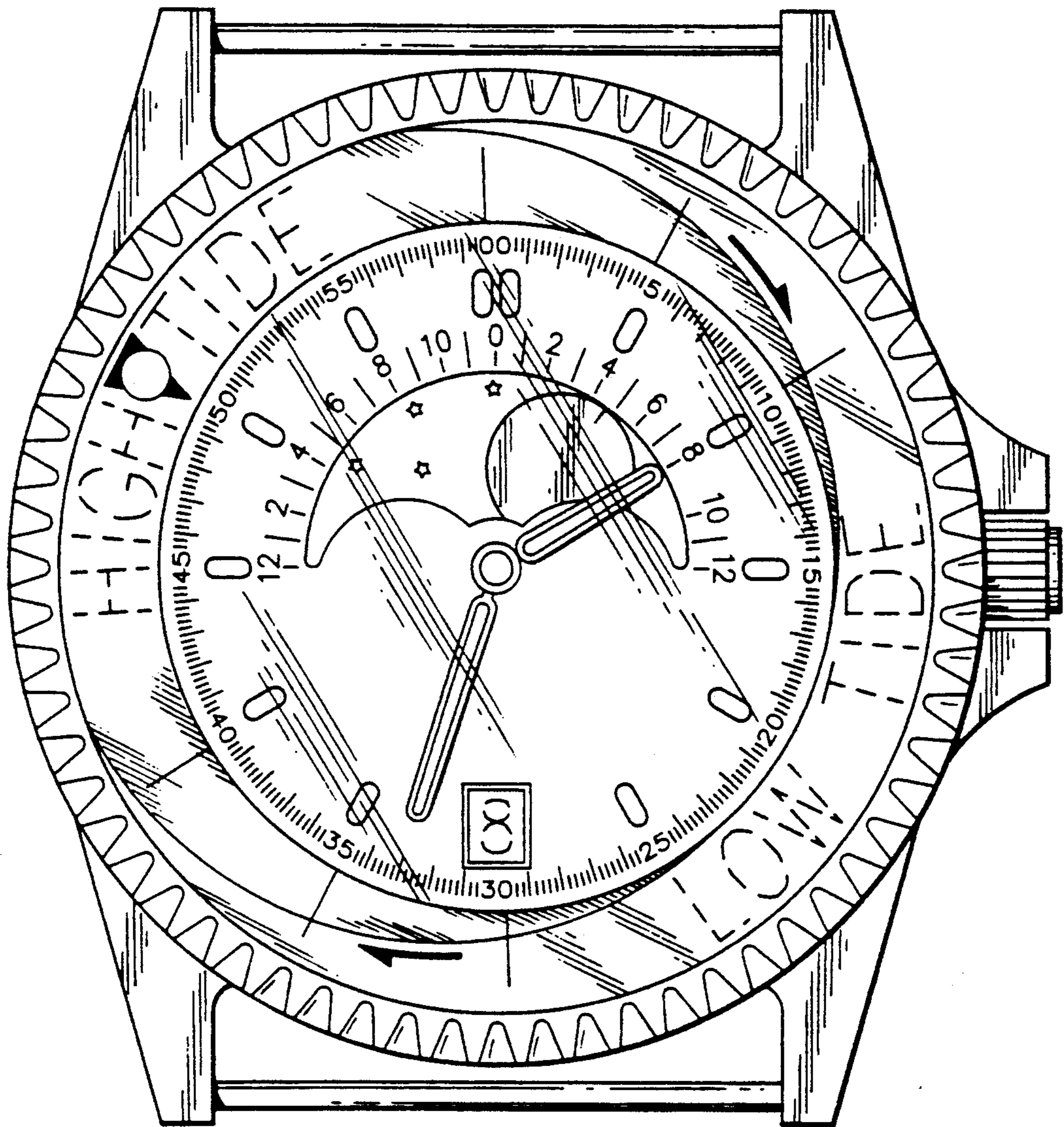

FIG. 2

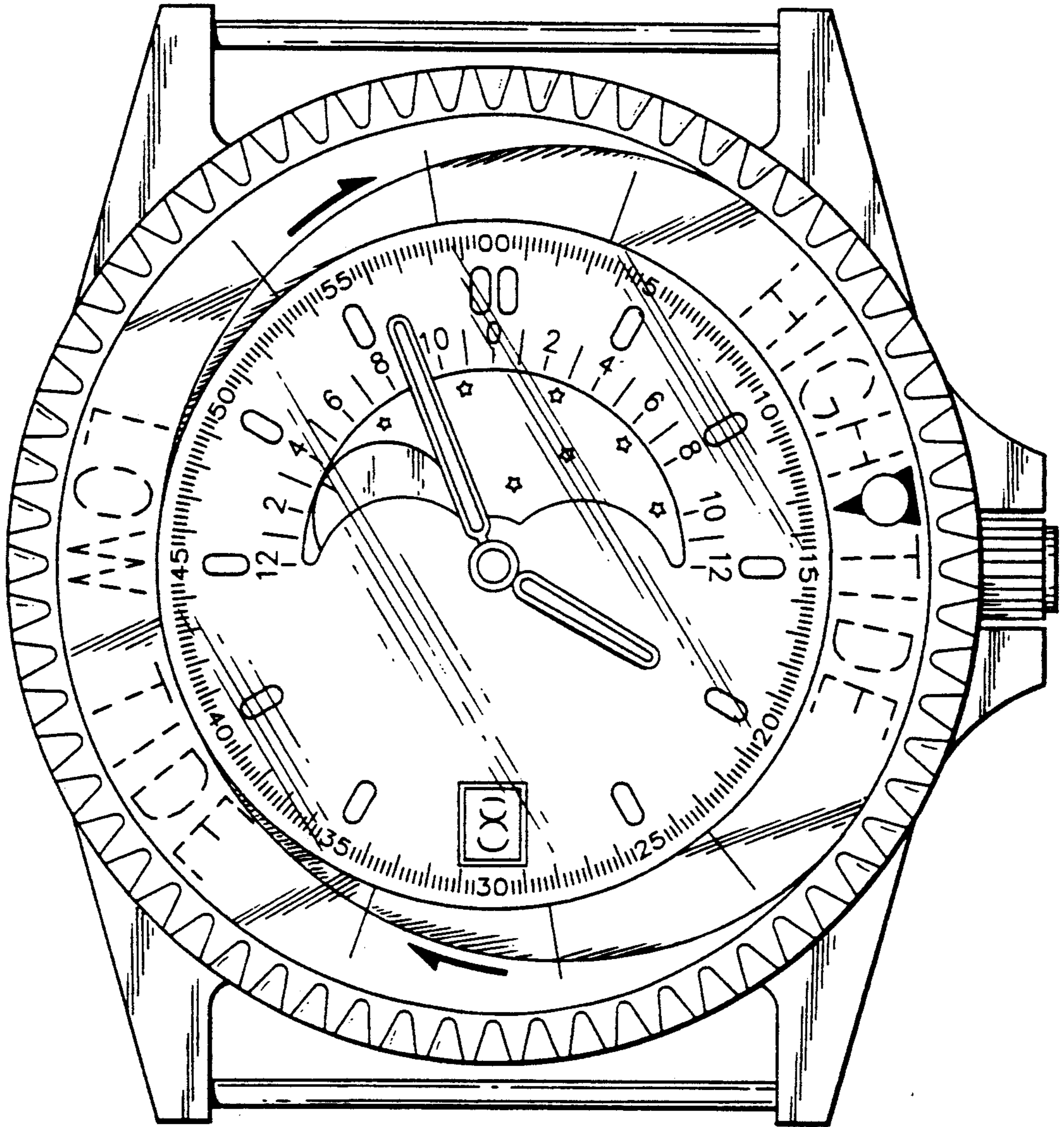

FIG. 3

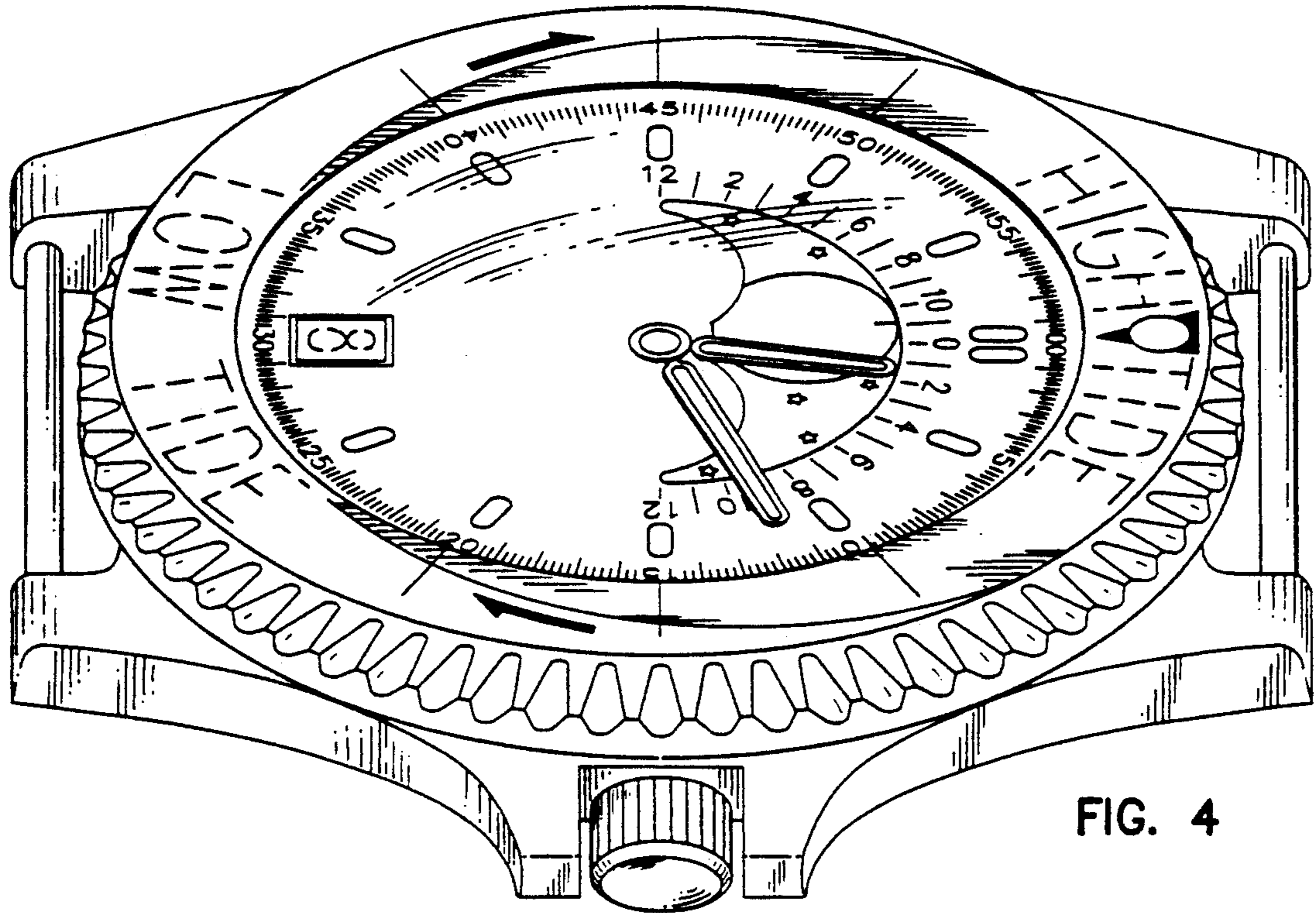

FIG. 4

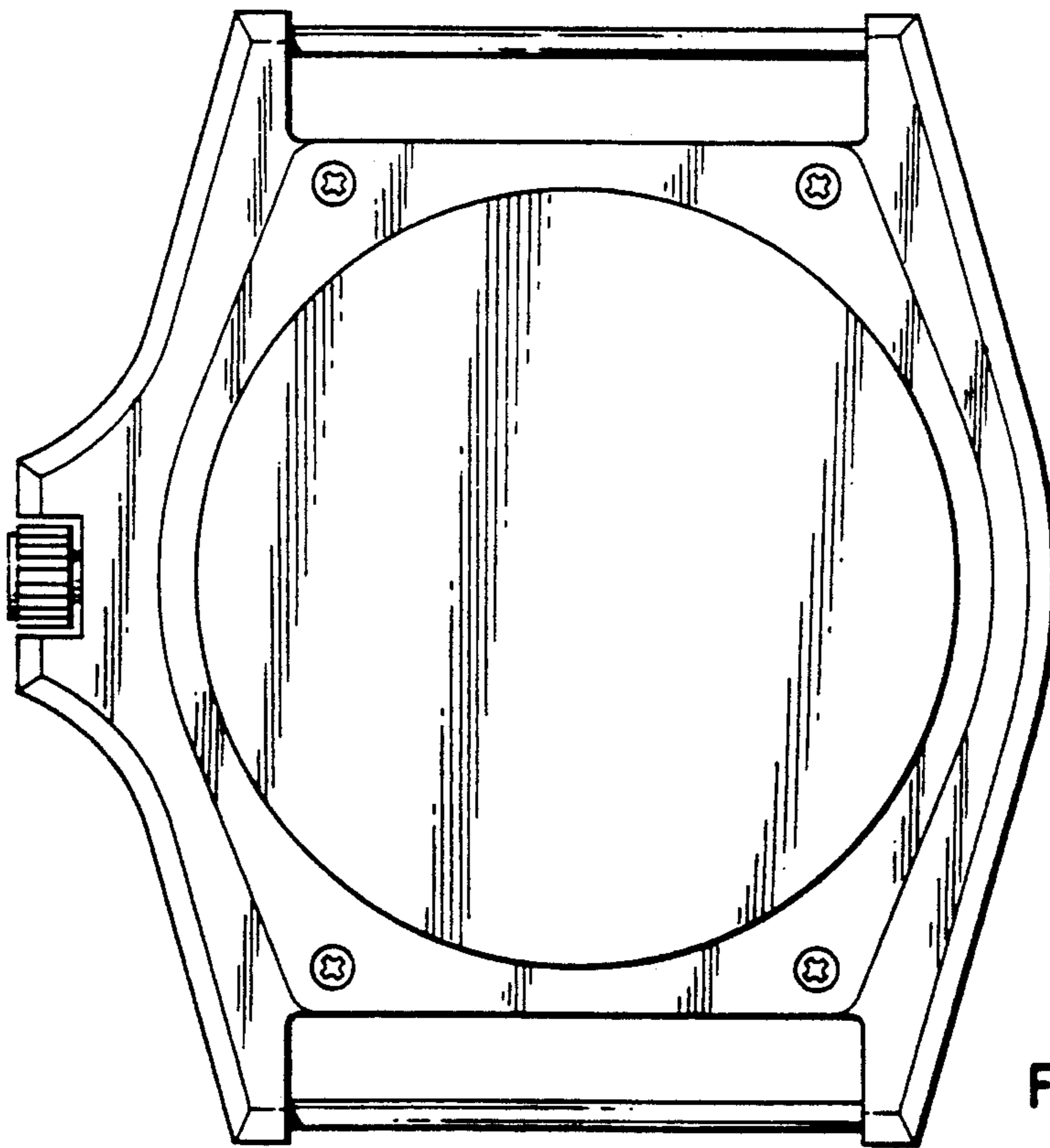

FIG. 5

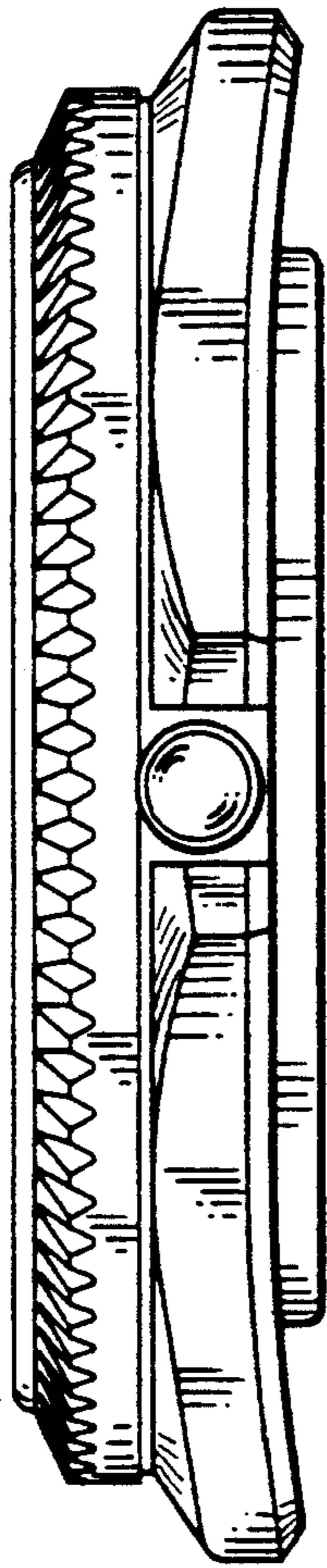

FIG. 7

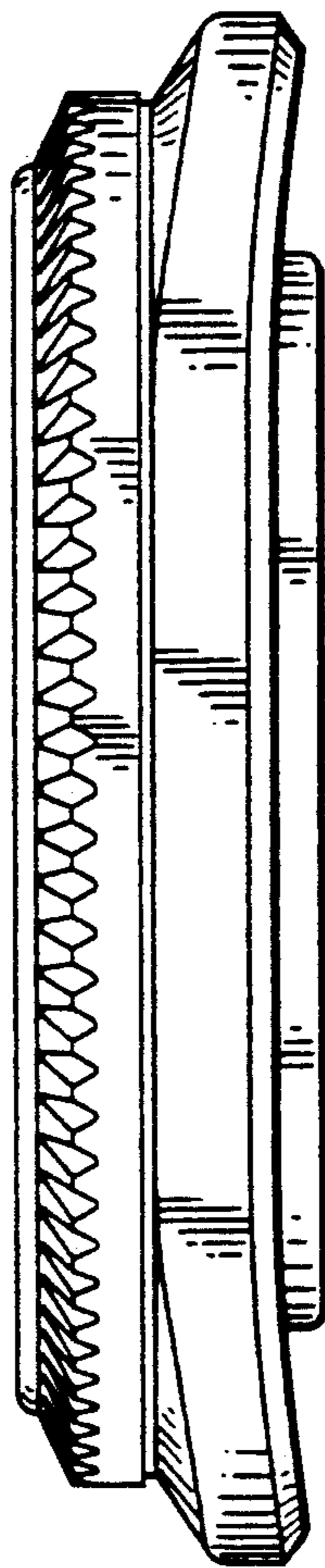

FIG. 6

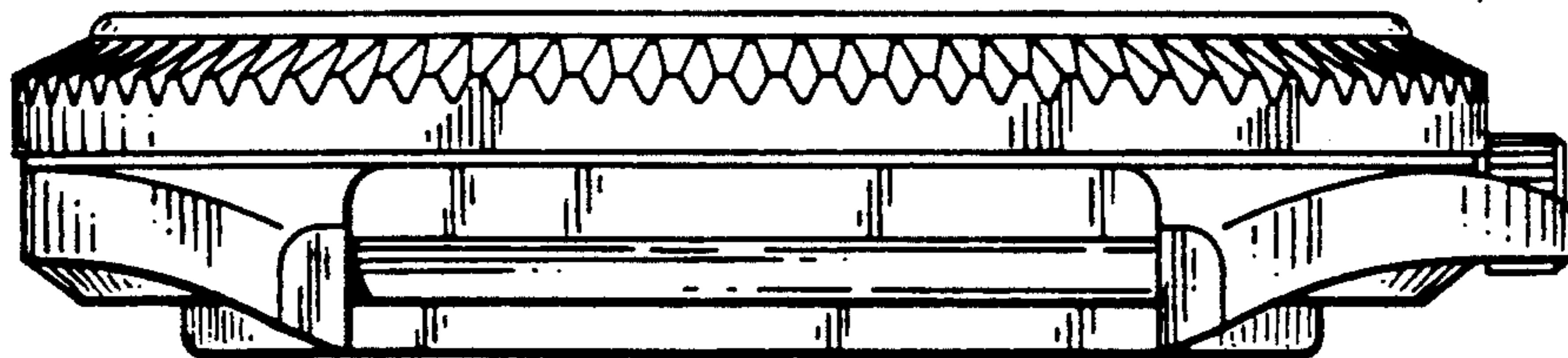

FIG. 8