



US00D343062S

United States Patent [19]

[11] Patent Number: Des. 343,062

Delage et al.

[45] Date of Patent: ** Jan. 11, 1994

[54] BRIEF CASE FOR BICYCLE

4,340,139 7/1982 Wilcox et al. 190/109 X

[75] Inventors: Alain Delage, Montreal; Richard Lamoureux, L'Assomption, both of Canada

OTHER PUBLICATIONS

Armadillon Bicycle Products, 1992 Catalog, Canada.

[73] Assignee: Plastiques Anchor LTEE, L'Assomption, Canada

Primary Examiner—Bernard Ansher
Assistant Examiner—Paula Mortimer
Attorney, Agent, or Firm—ROBIC

[**] Term: 14 Years

[57] CLAIM

[21] Appl. No.: 853,163

The ornamental design for a brief case for bicycle, as shown and described.

[22] Filed: Mar. 17, 1992

DESCRIPTION

[30] Foreign Application Priority Data

Dec. 17, 1991 [CA] Canada 1712916

[52] U.S. Cl. D3/70; D12/158

[58] Field of Search D3/73, 70, 76; 190/100, 190/109-115; 206/349, 315.9; D12/158

FIG. 1 is a front perspective view of a brief case for bicycle, showing our new design;
FIG. 2 is a side elevational view thereof;
FIG. 3 is an opposite side elevational view thereof;
FIG. 4 is a rear elevational view thereof;
FIG. 5 is a front elevational view thereof;
FIG. 6 is a top plan view thereof;
FIG. 7 is a bottom plan view thereof;
FIG. 8 is a front perspective view of a brief case for bicycle showing our new design, the difference being the raised stripe pattern and the narrower width;
FIG. 9 is a side elevational view thereof;
FIG. 10 is an opposite side elevational view thereof;
FIG. 11 is a rear elevational view thereof;
FIG. 12 is a front elevational view thereof;
FIG. 13 is a top plan view thereof; and,
FIG. 14 is a bottom plan view thereof.

[56] References Cited

U.S. PATENT DOCUMENTS

- D. 247,326 2/1978 Warren, Jr. D12/158 X
- D. 253,762 12/1979 Vetter et al. D12/158
- D. 280,806 10/1985 Hsw D12/158
- D. 281,313 11/1985 Beprestis et al. D12/158
- D. 282,061 1/1986 Abe D12/158
- 3,092,225 6/1963 Kivett 206/315.9
- 3,565,305 2/1971 Belokin, Jr. 190/109 X
- 3,788,532 1/1974 Bish D12/158
- 4,241,857 12/1980 Derethian et al. 190/115 X

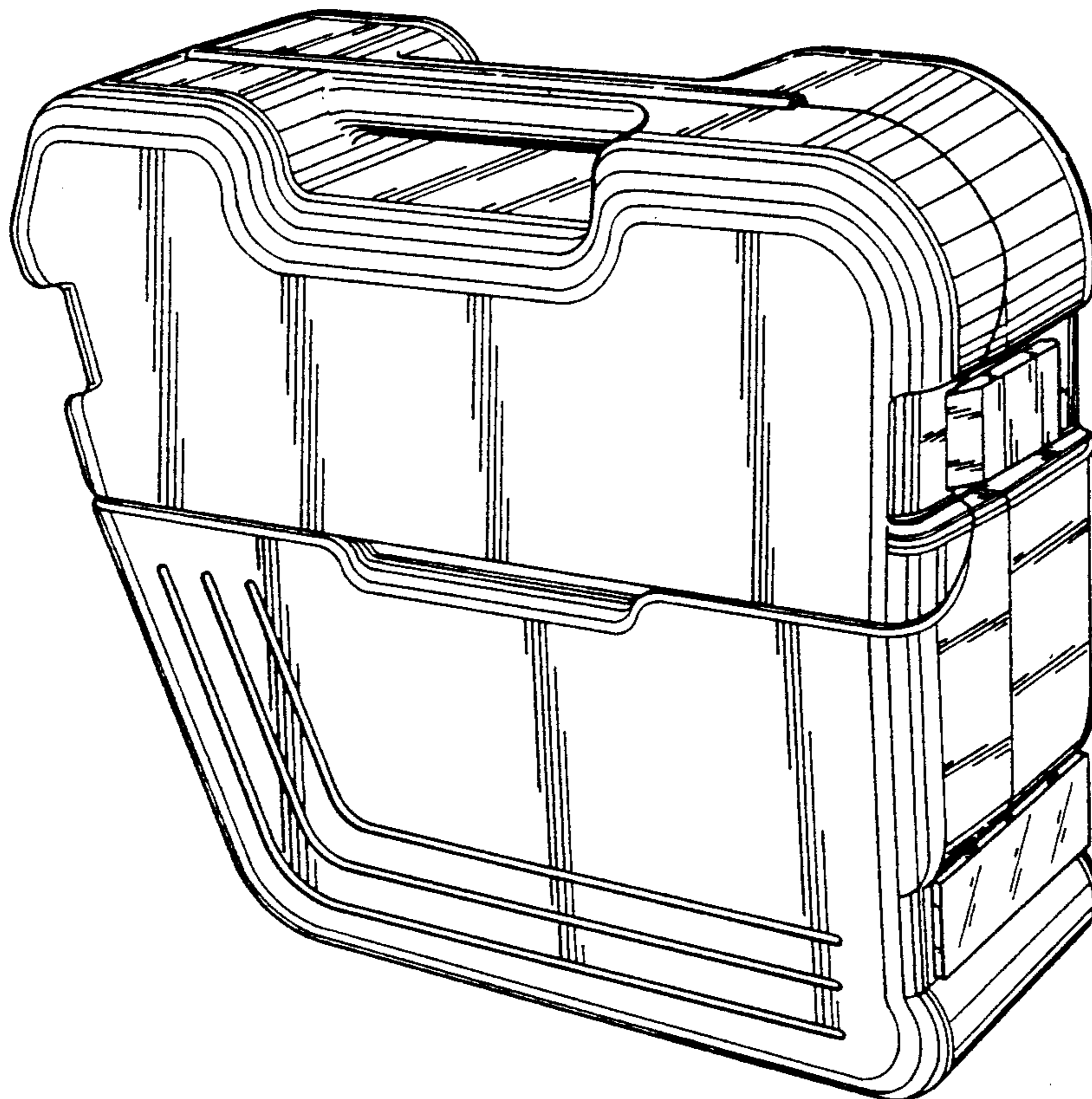

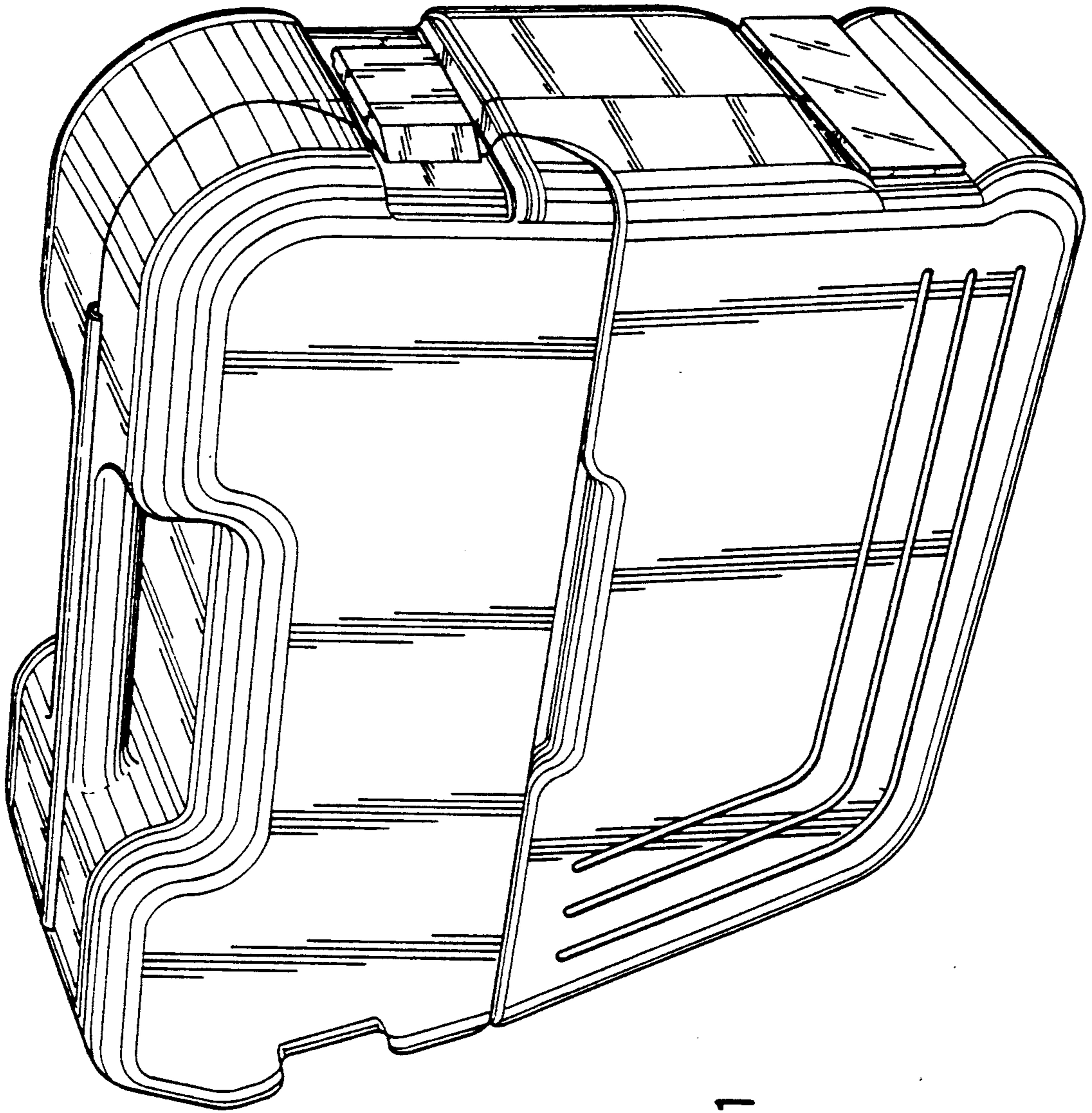

FIG. 1

FIG. 2

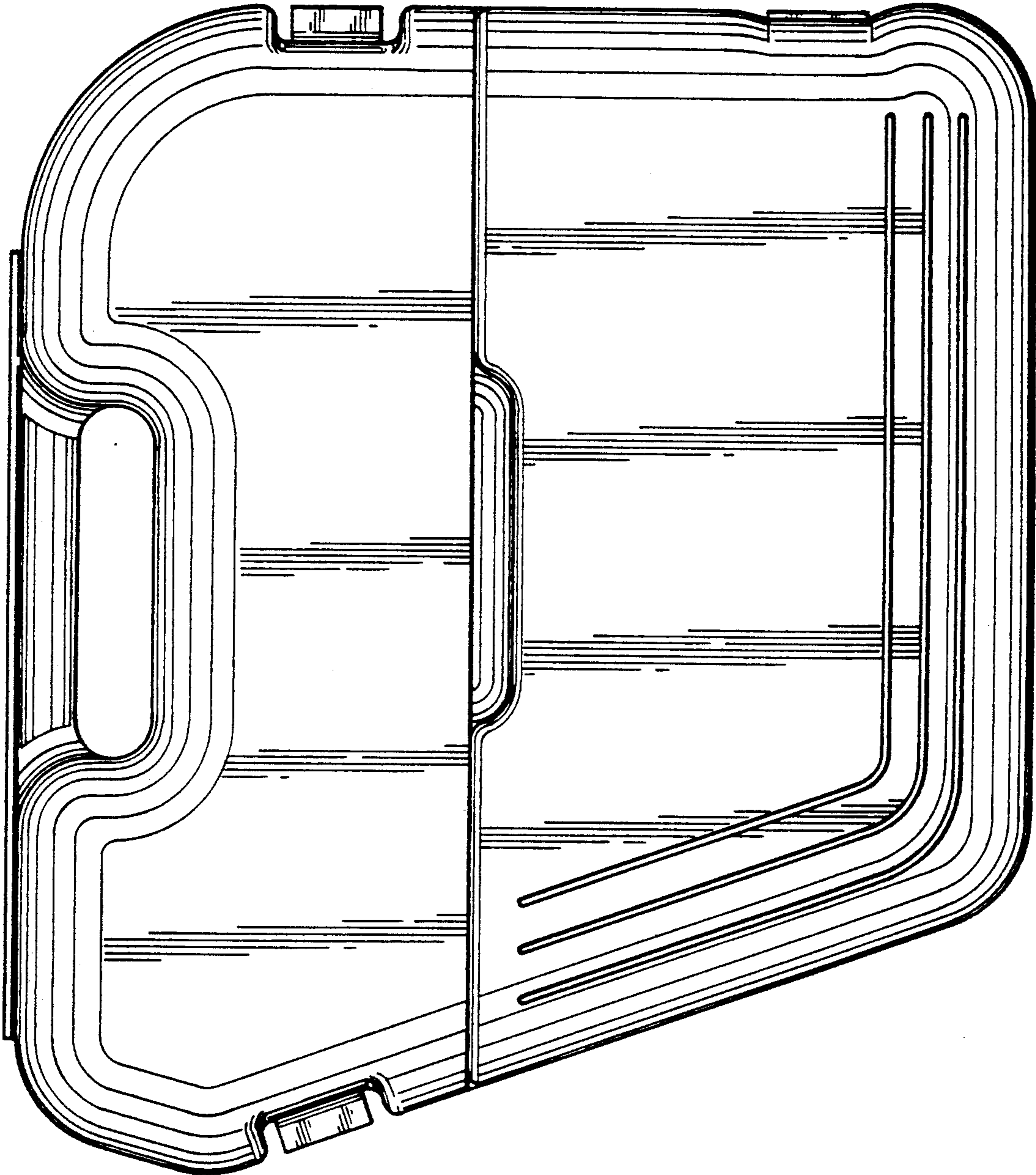

FIG. 3

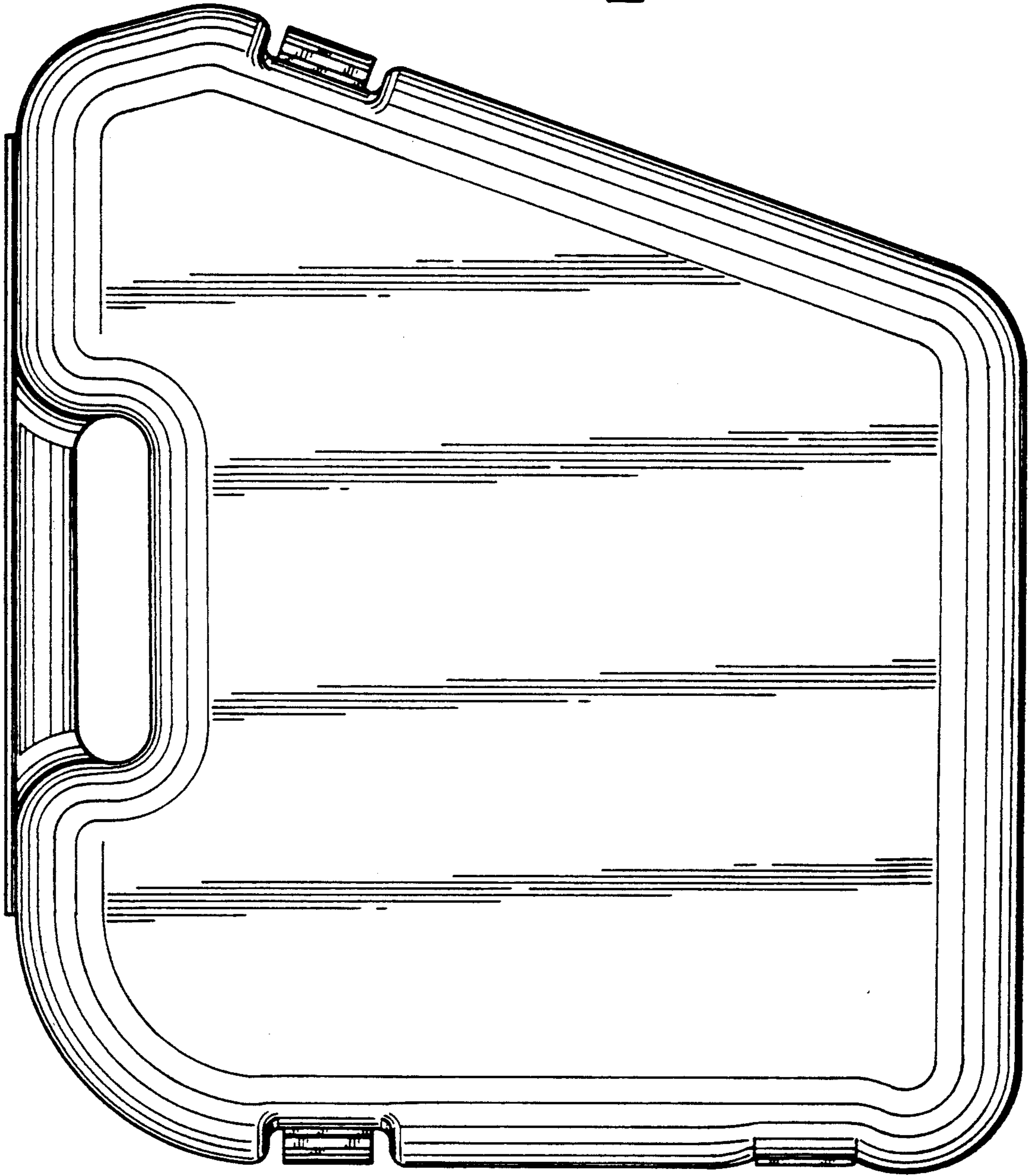

FIG. 5

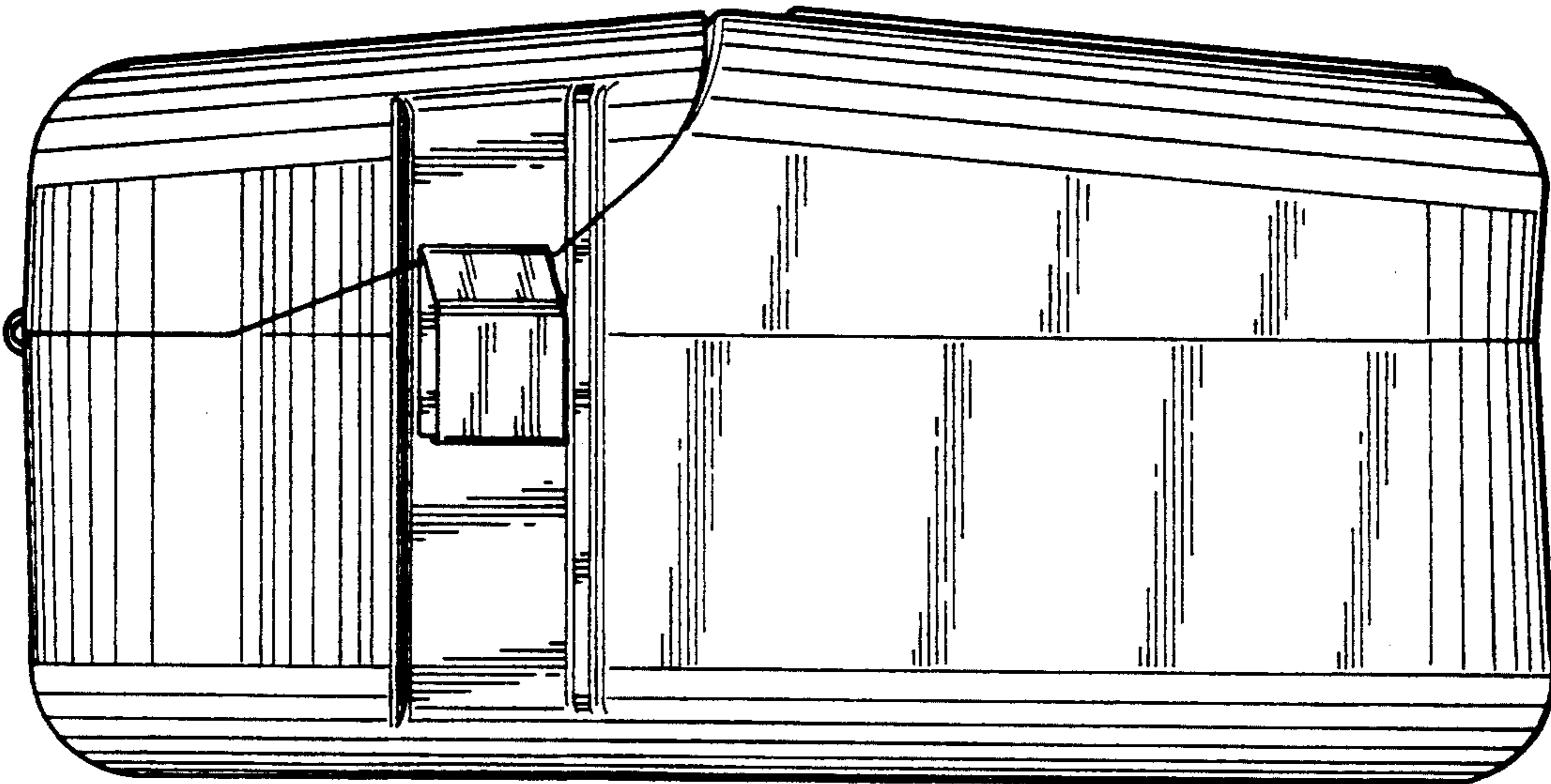

FIG. 4

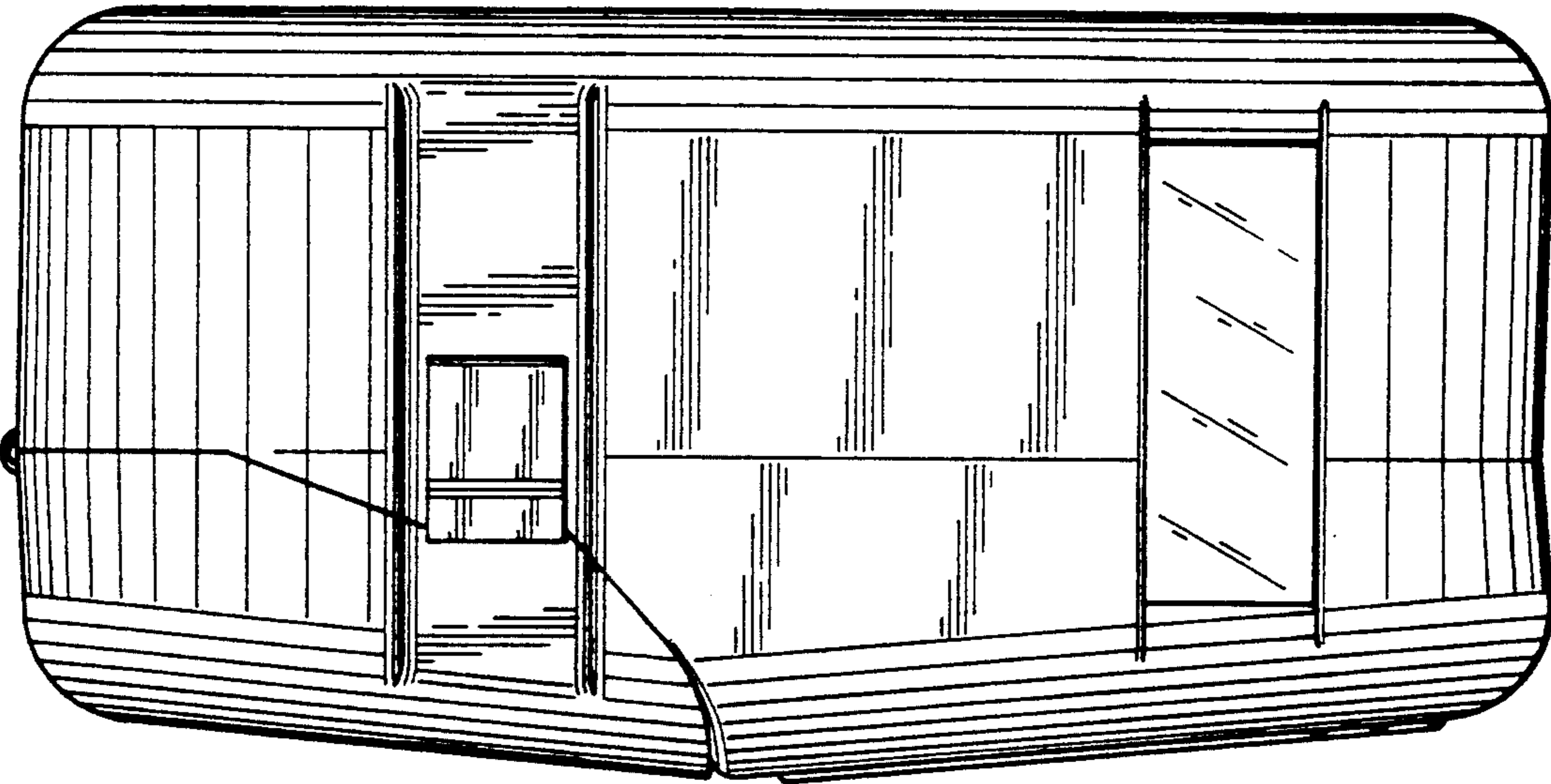

FIG. 6

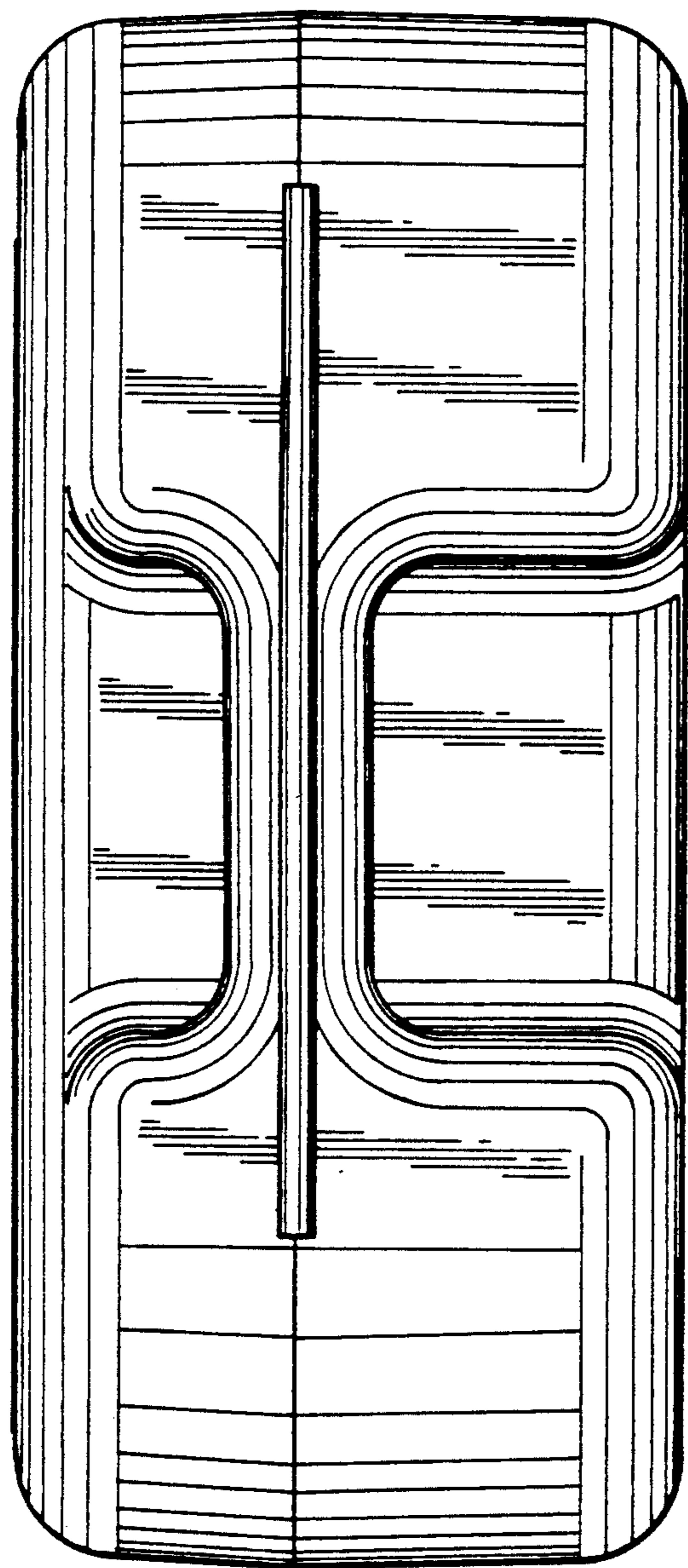
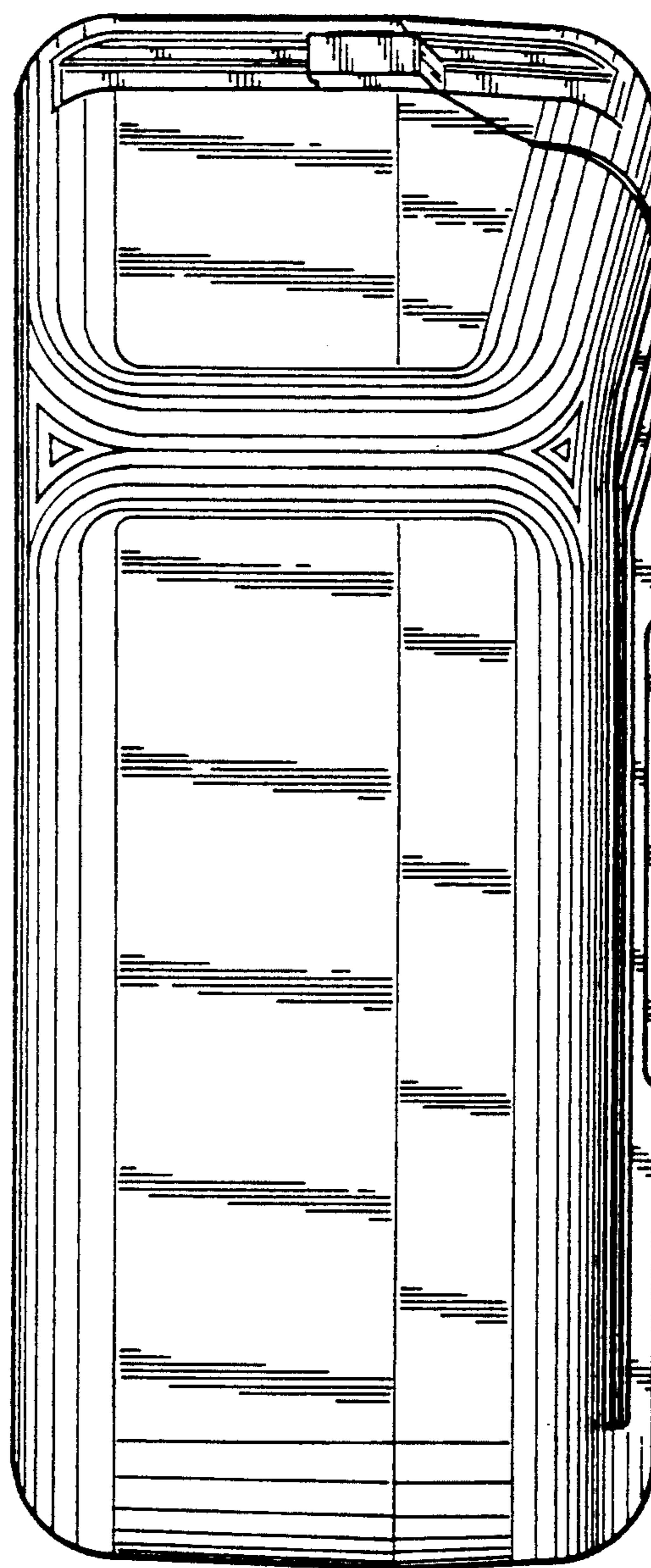

FIG. 7



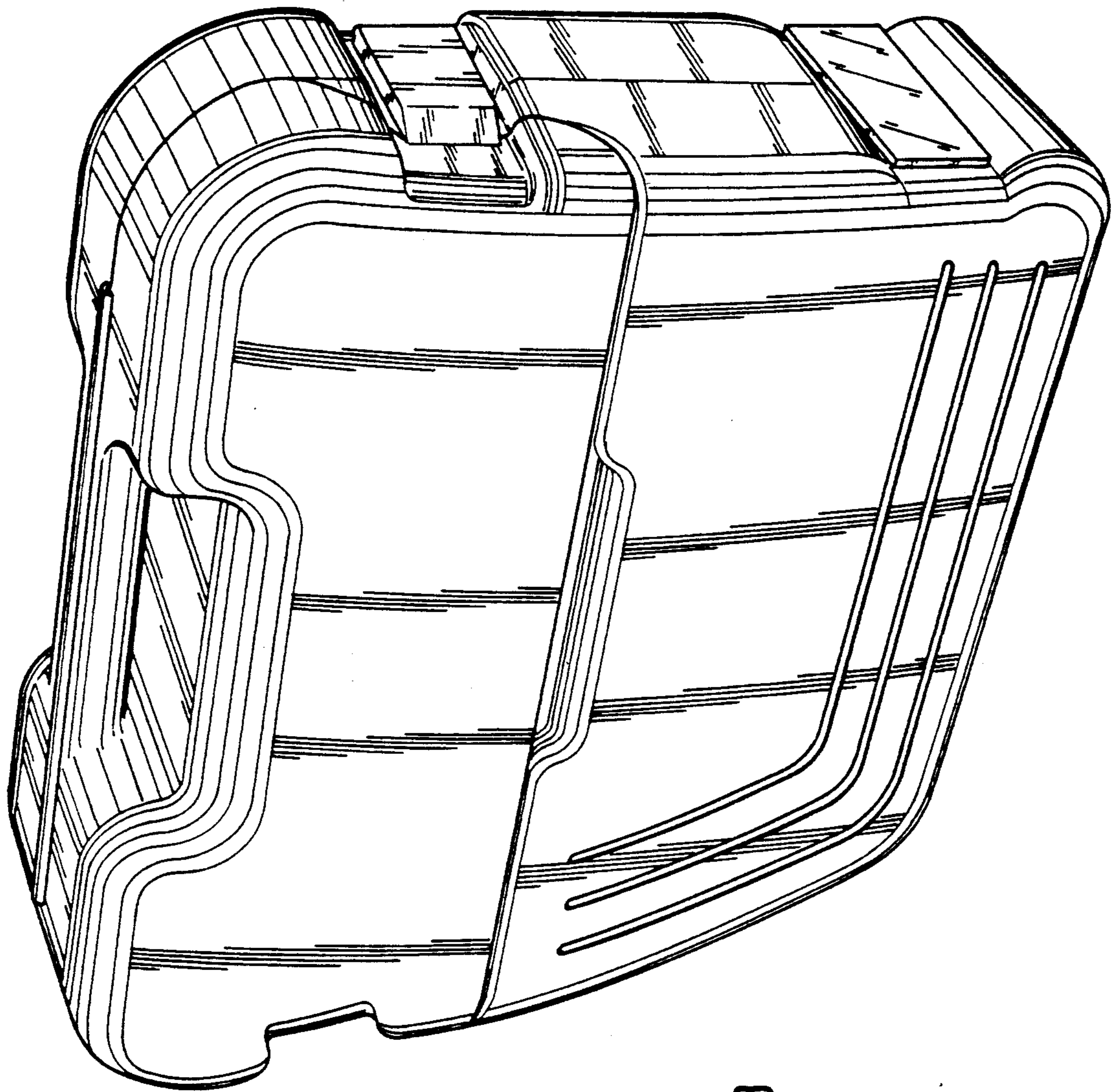

FIG. 8

FIG. 9

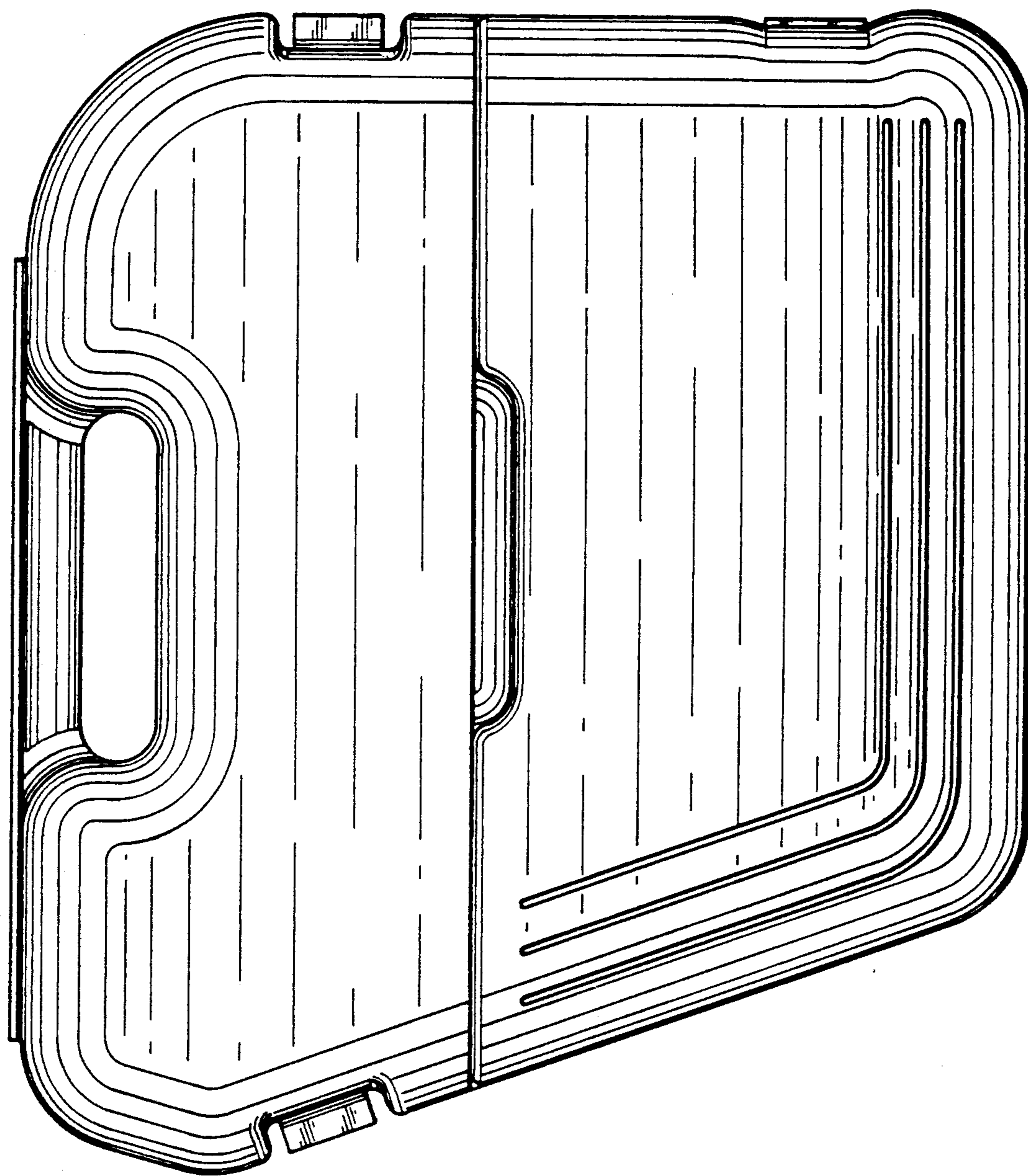

FIG. 10

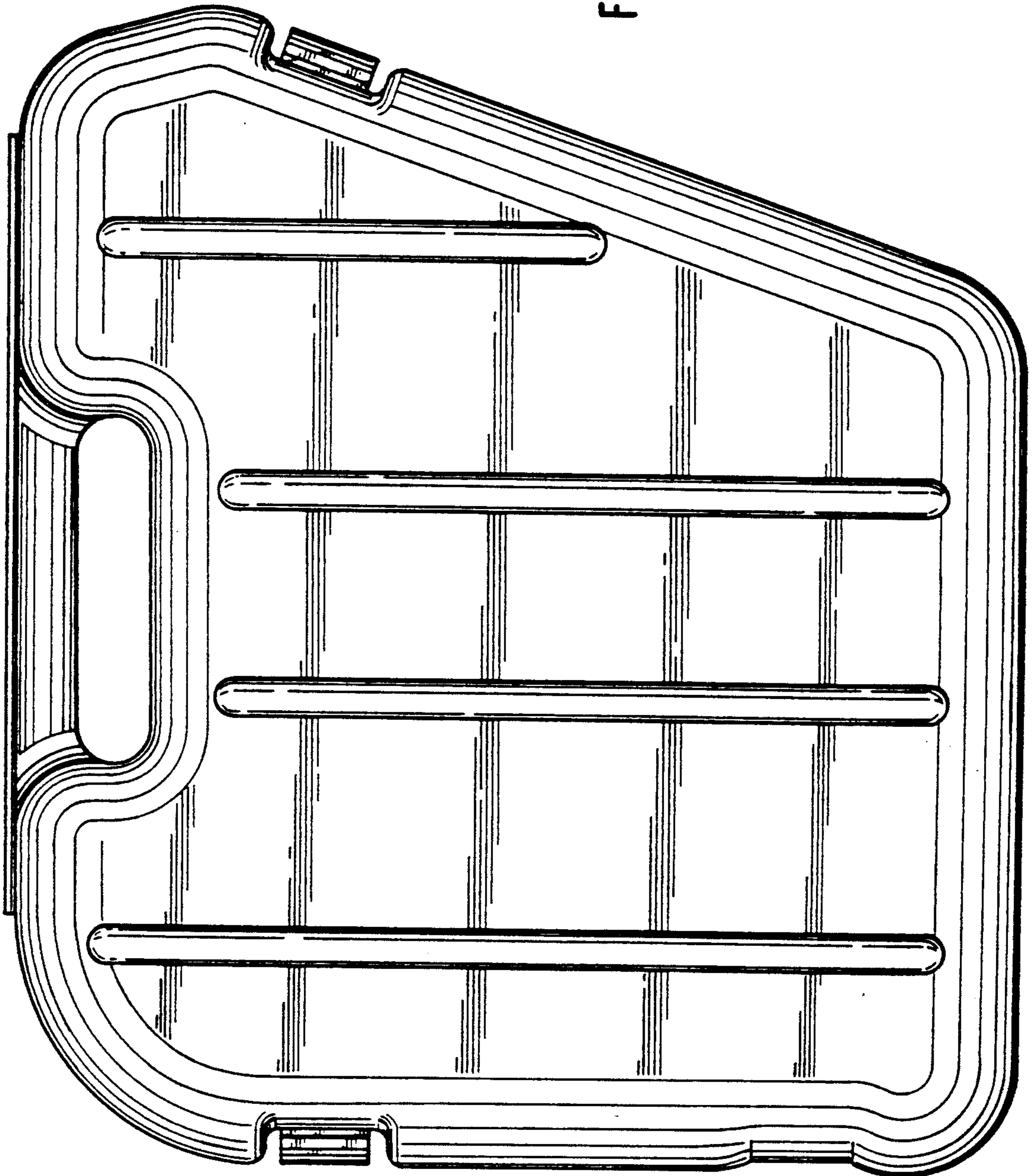

FIG. 12

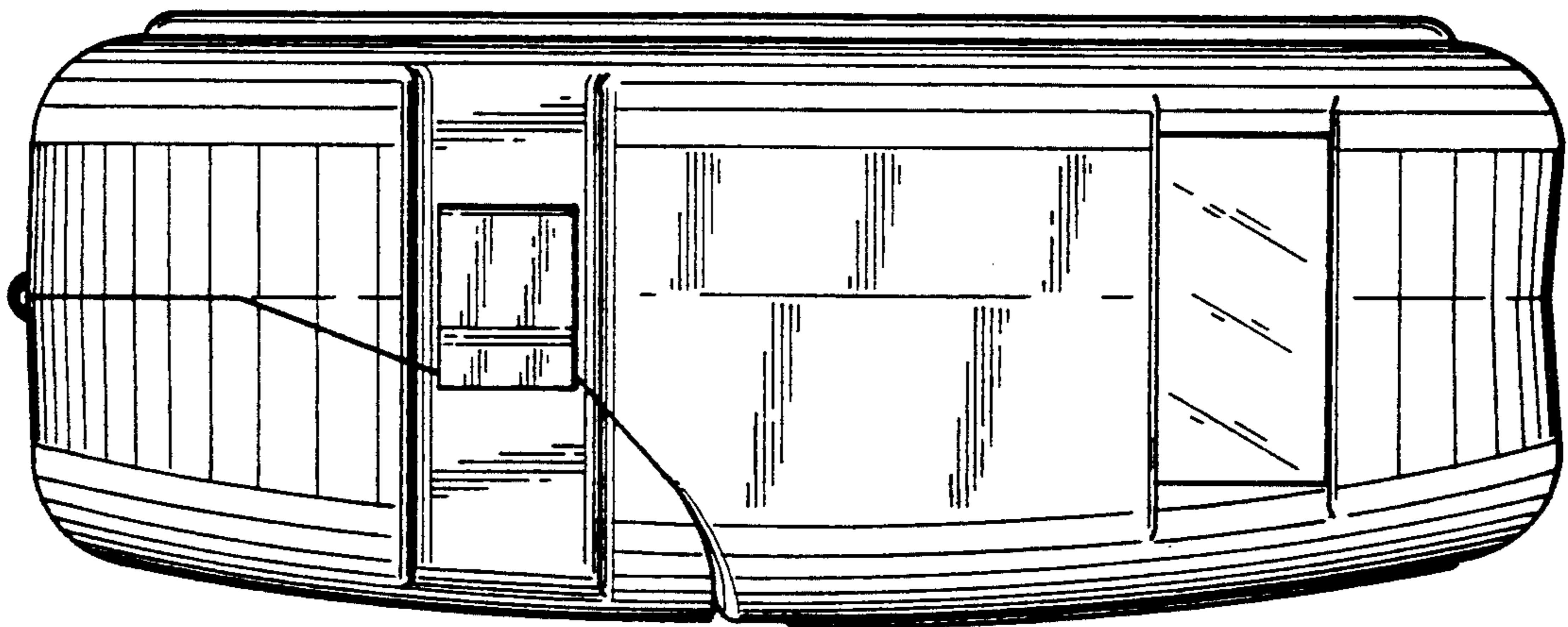
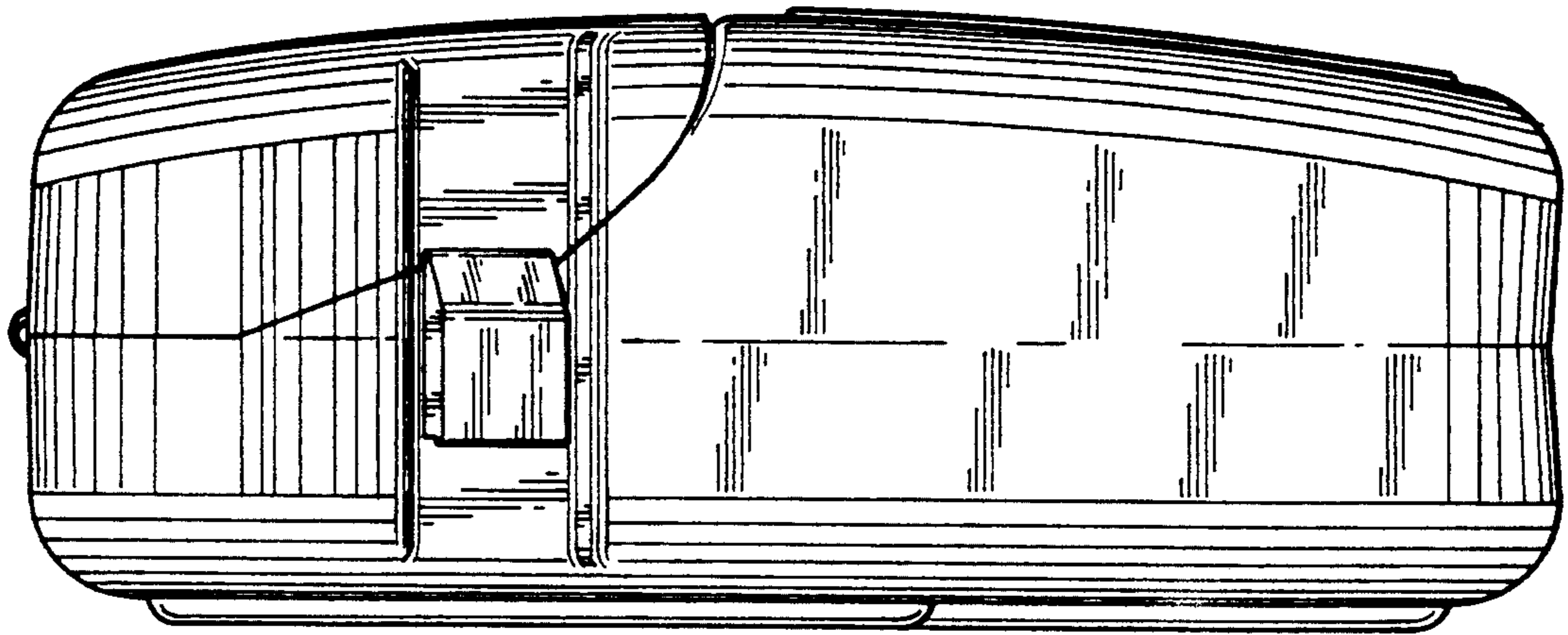

FIG. 11

FIG. 13

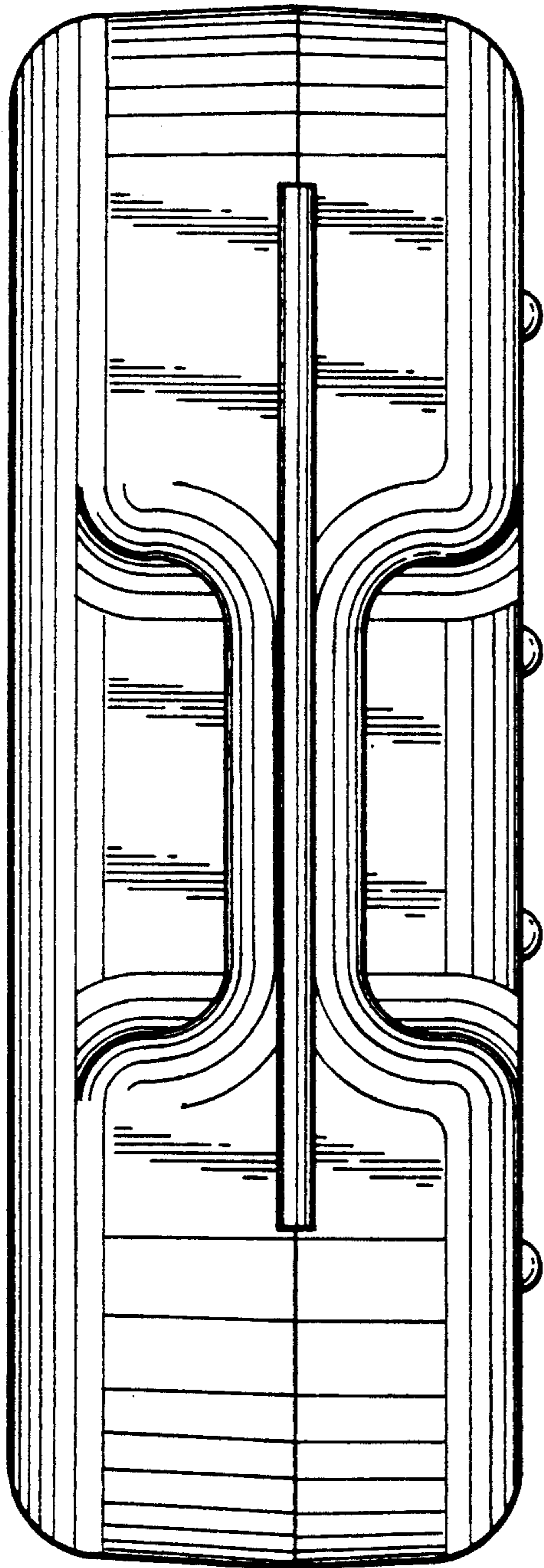

FIG. 14

