



US00D342856S

United States Patent [19]
Hagen

[11] **Patent Number: Des. 342,856**
[45] **Date of Patent: ** Jan. 4, 1994**

- [54] **COMBINED ABDUCTION AND POSITION CUSHION SET**
- [76] **Inventor: Timothy G. Hagen, 2340 Bernard St., Raleigh, N.C. 27608**
- [**] **Term: 14 Years**
- [21] **Appl. No.: 948,781**
- [22] **Filed: Sep. 21, 1992**
- [52] **U.S. Cl. D6/601; D6/596**
- [58] **Field of Search D6/595, 596, 601, 604; 297/459, 439, 391; 5/632, 636, 648, 650, 646, 647; D24/190**

[56] **References Cited**
U.S. PATENT DOCUMENTS

| | | | | |
|------------|--------|----------------|-------|--------|
| D. 257,105 | 9/1980 | Morris | | D6/601 |
| 3,946,451 | 3/1976 | Spann | | 5/650 |
| 4,805,605 | 2/1989 | Glassman | | 5/650 |
| 4,910,818 | 3/1990 | Grabill et al. | | 5/648 |
| 5,046,487 | 9/1991 | Scott | | 5/650 |
| 5,117,522 | 6/1992 | Everett | | 5/455 |
| 5,125,123 | 6/1992 | Engle | | 5/648 |

Primary Examiner—Wallace R. Burke
Assistant Examiner—Lisa Lichtenstein
Attorney, Agent, or Firm—John G. Mills and Associates

[57] **CLAIM**

The ornamental design for a combined abduction and position cushion set, as shown and described.

DESCRIPTION

FIG. 1 is a perspective view of the combined abduction and position cushion set showing my new design in use; FIG. 2 is an enlarged top plan view of the knee extension and hip abductor cushion, shown separately for clarity of illustration; FIG. 3 is a bottom plan view of FIG. 2; FIG. 4 is a front elevational view of FIG. 2; FIG. 5 is a rear elevational view of FIG. 2; FIG. 6 is a right side elevational view of FIG. 2, the left side being a mirror image of that shown; FIG. 7 is an enlarged top plan view of the shoulder abduction positioner cushion, shown separately for clarity of illustration; FIG. 8 is a bottom plan view of FIG. 7; FIG. 9 is a front elevational view of FIG. 7; FIG. 10 is a rear elevational view of FIG. 7; FIG. 11 is a right side elevational view of FIG. 7, the left side being a mirror image of that shown; FIG. 12 is an enlarged top plan view of the elbow extension positioner pillow, shown separately for clarity of illustration; FIG. 13 is a bottom plan view of FIG. 12; FIG. 14 is an end elevational view of FIG. 12, the opposite end being a mirror image of that shown; and, FIG. 15 is a side elevational view of FIG. 12, the opposite side being a mirror image of that shown. The broken line showing of an incogitant patient in FIG. 1, is for illustrative purposes only, and forms no part of the claimed design.

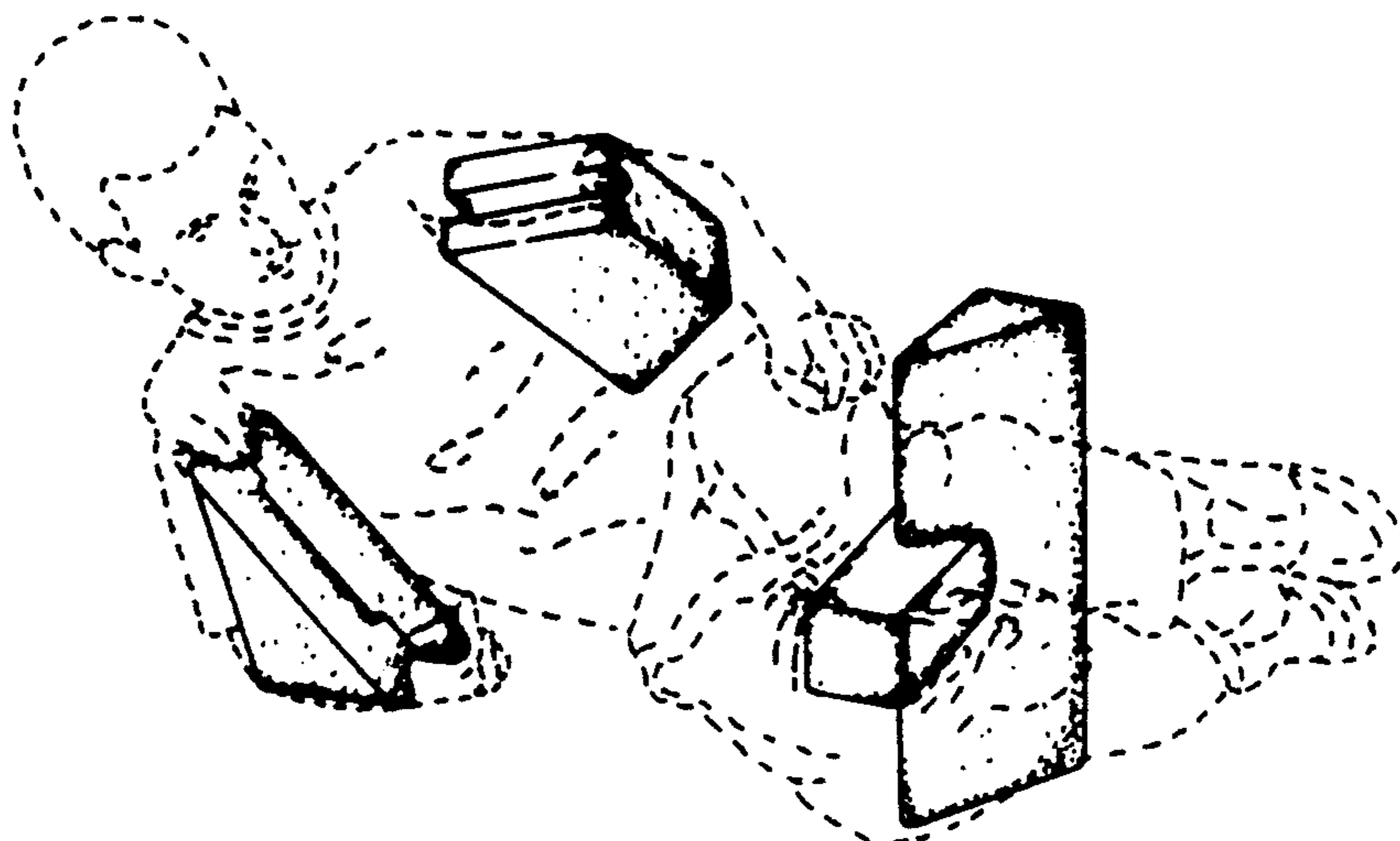

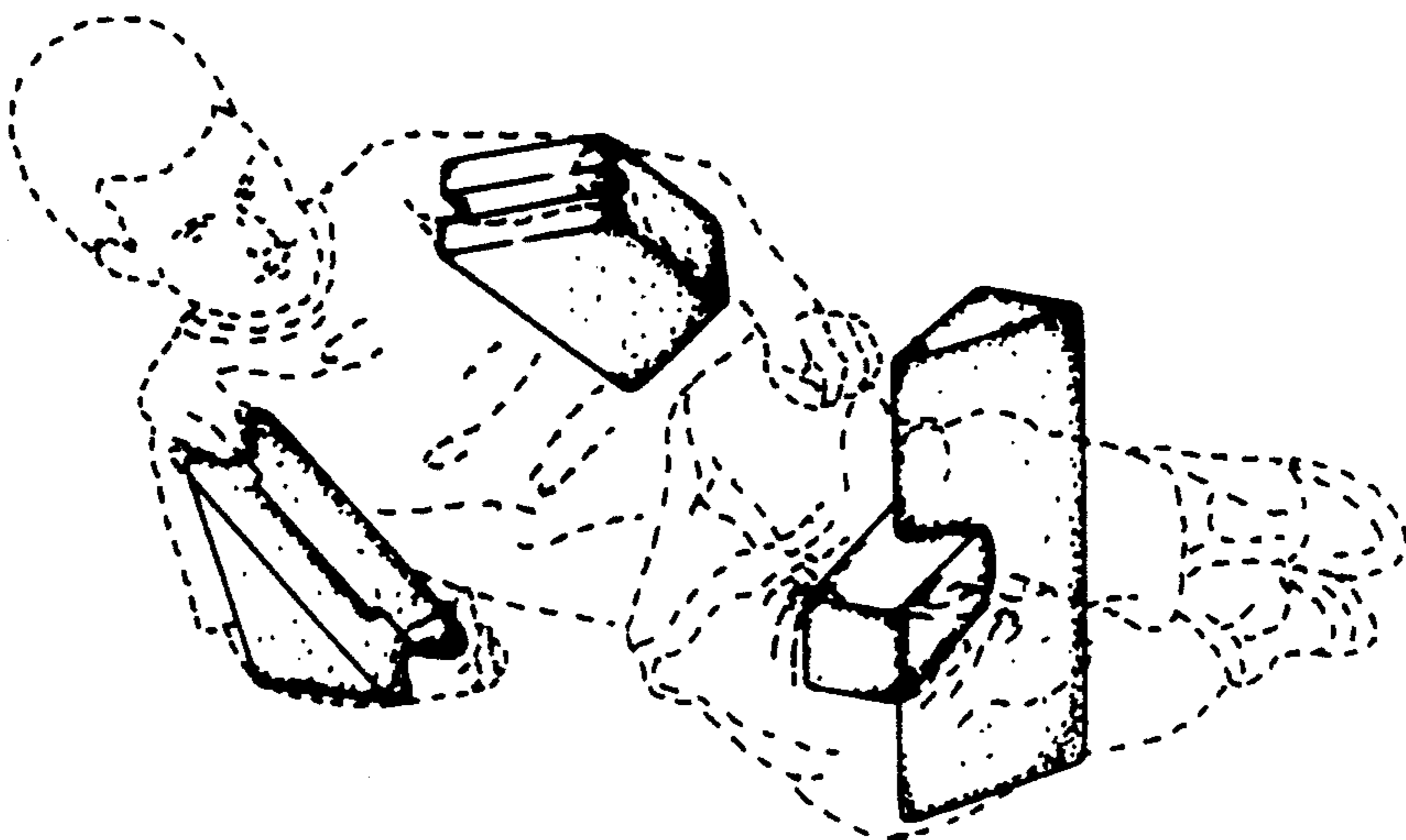

FIG. 1

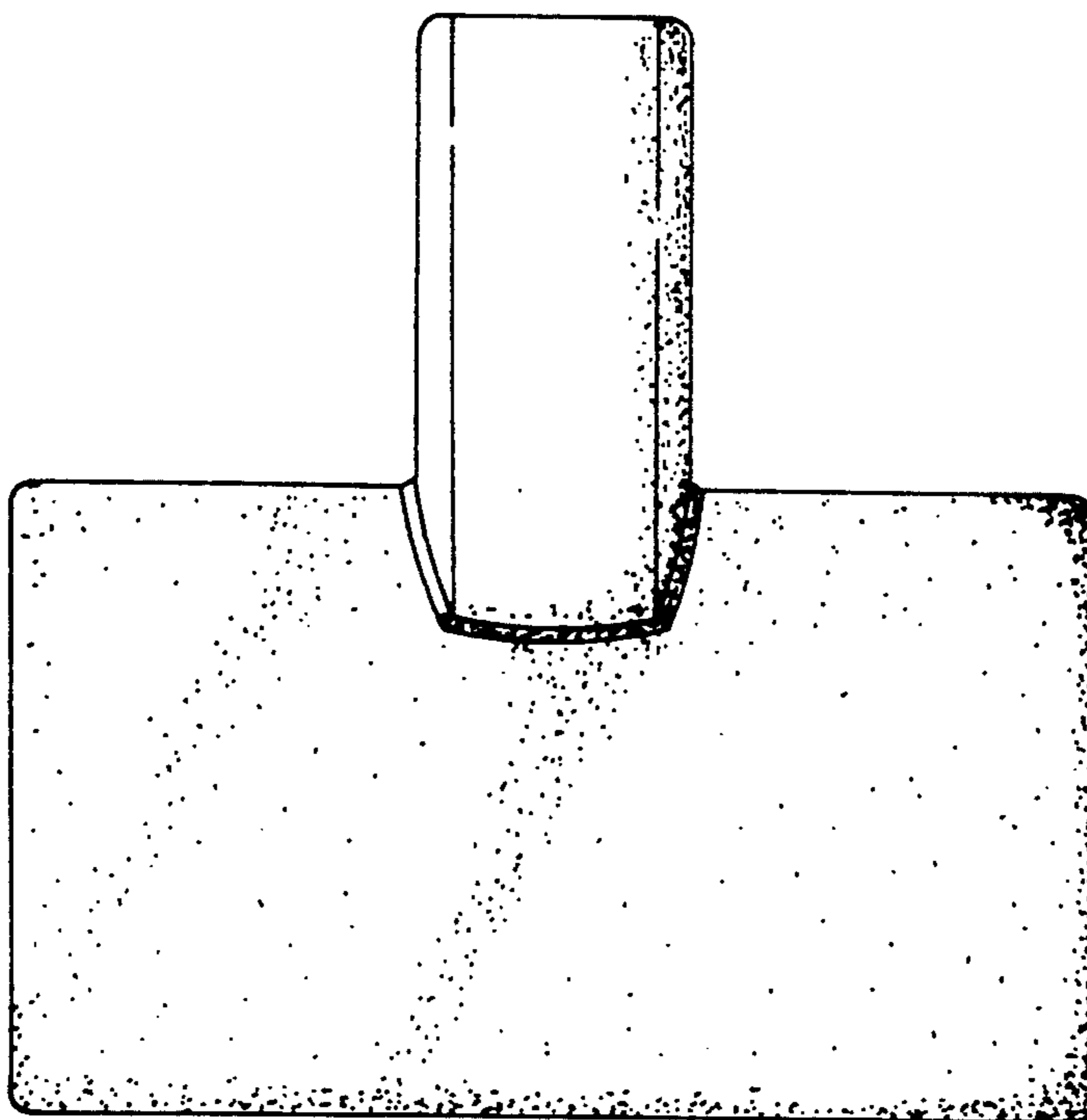

FIG. 2

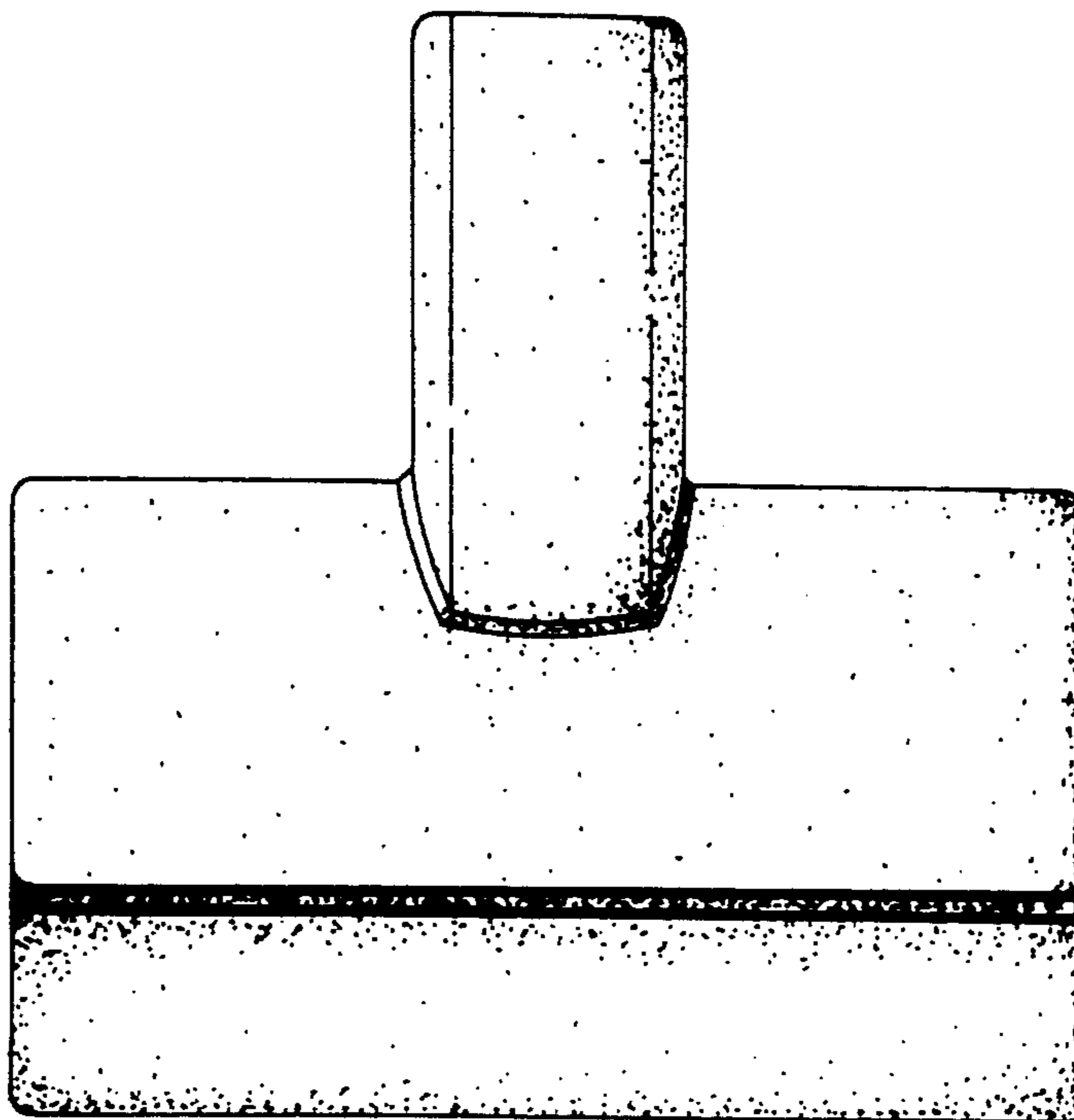

FIG. 3

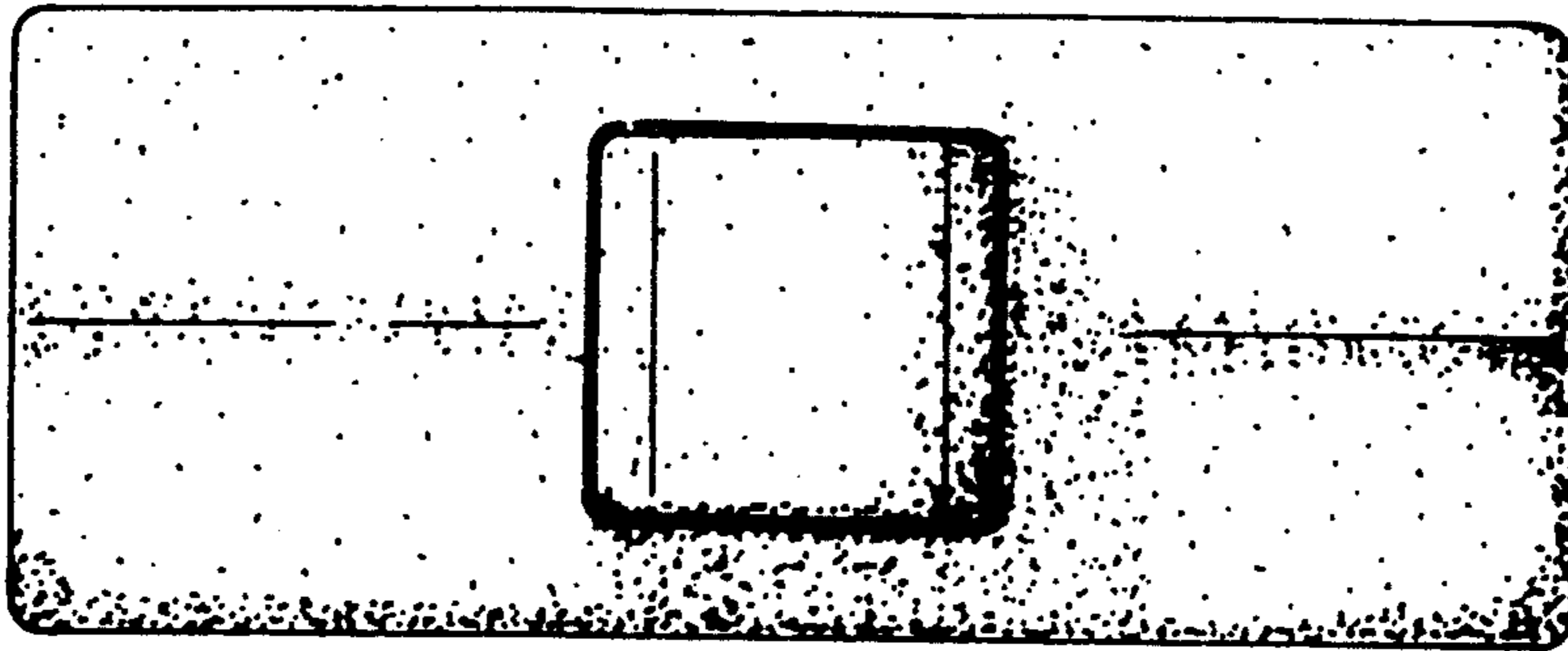

FIG. 4

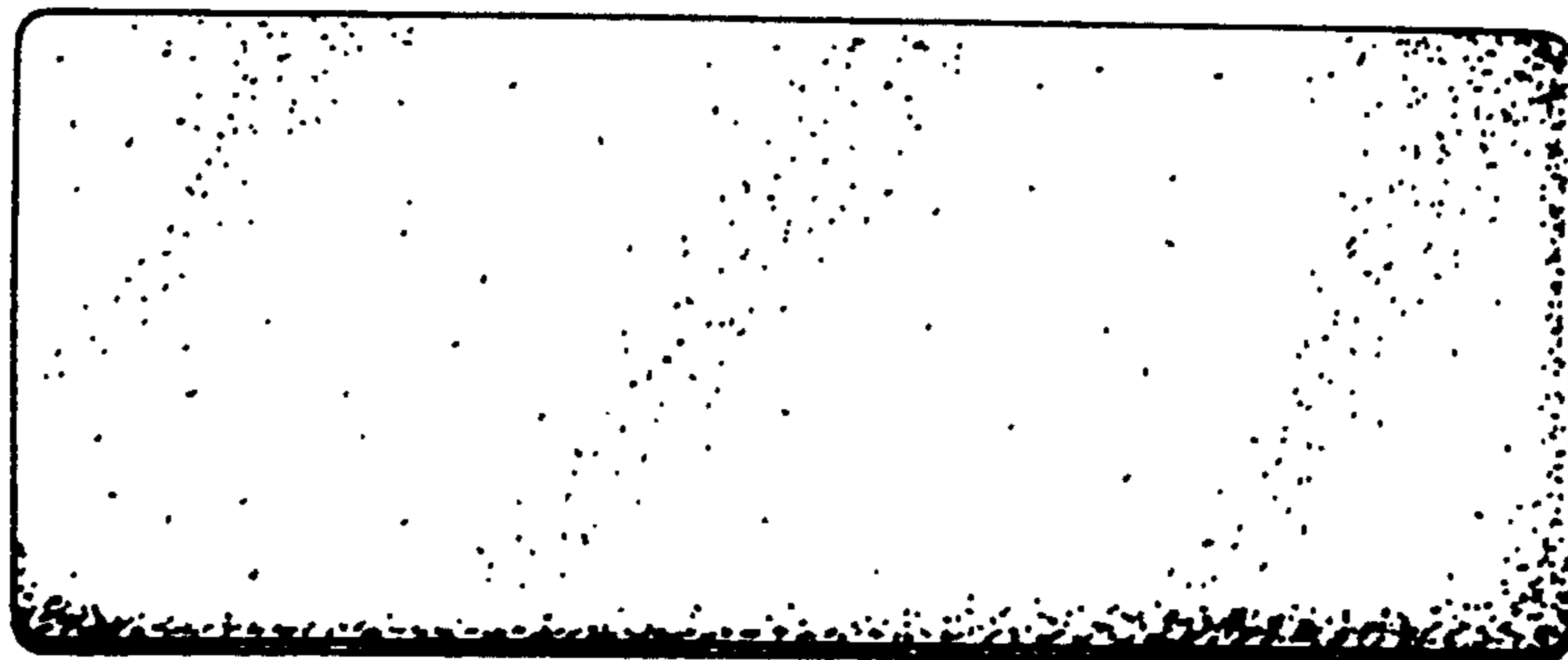

FIG. 5

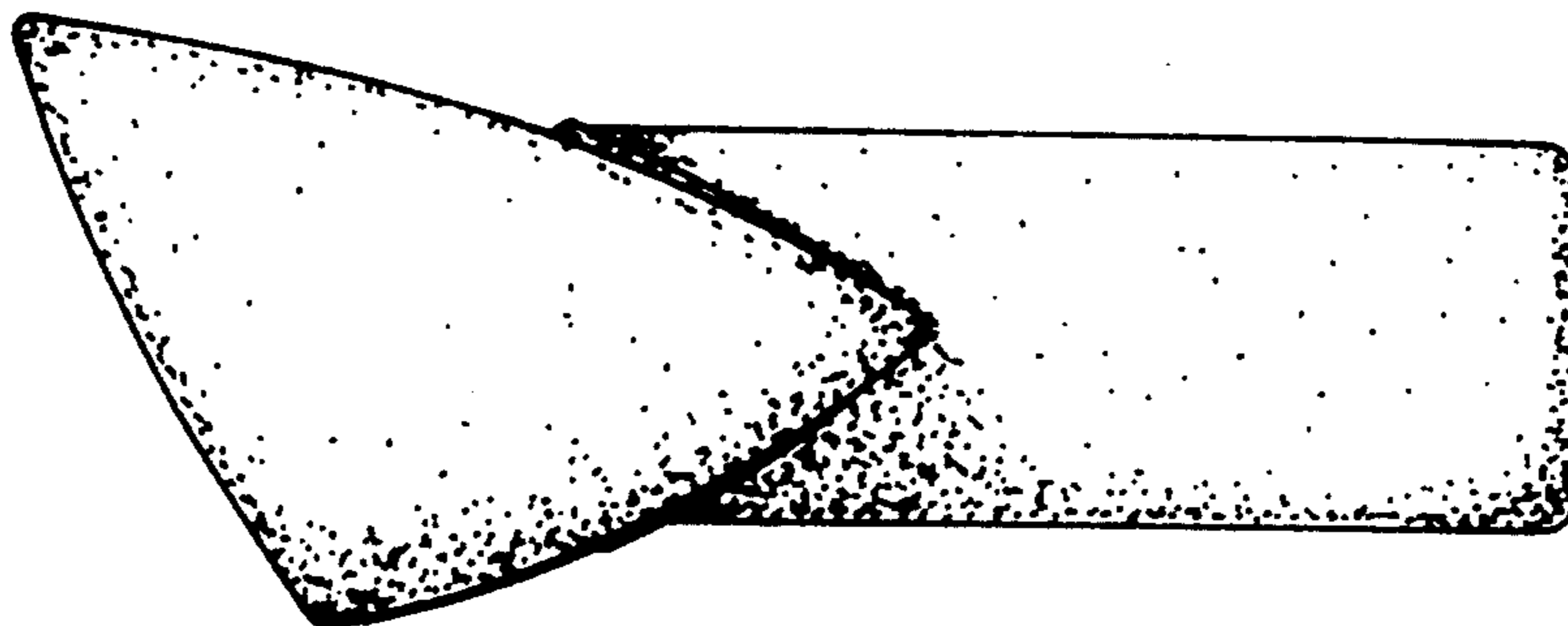

FIG. 6

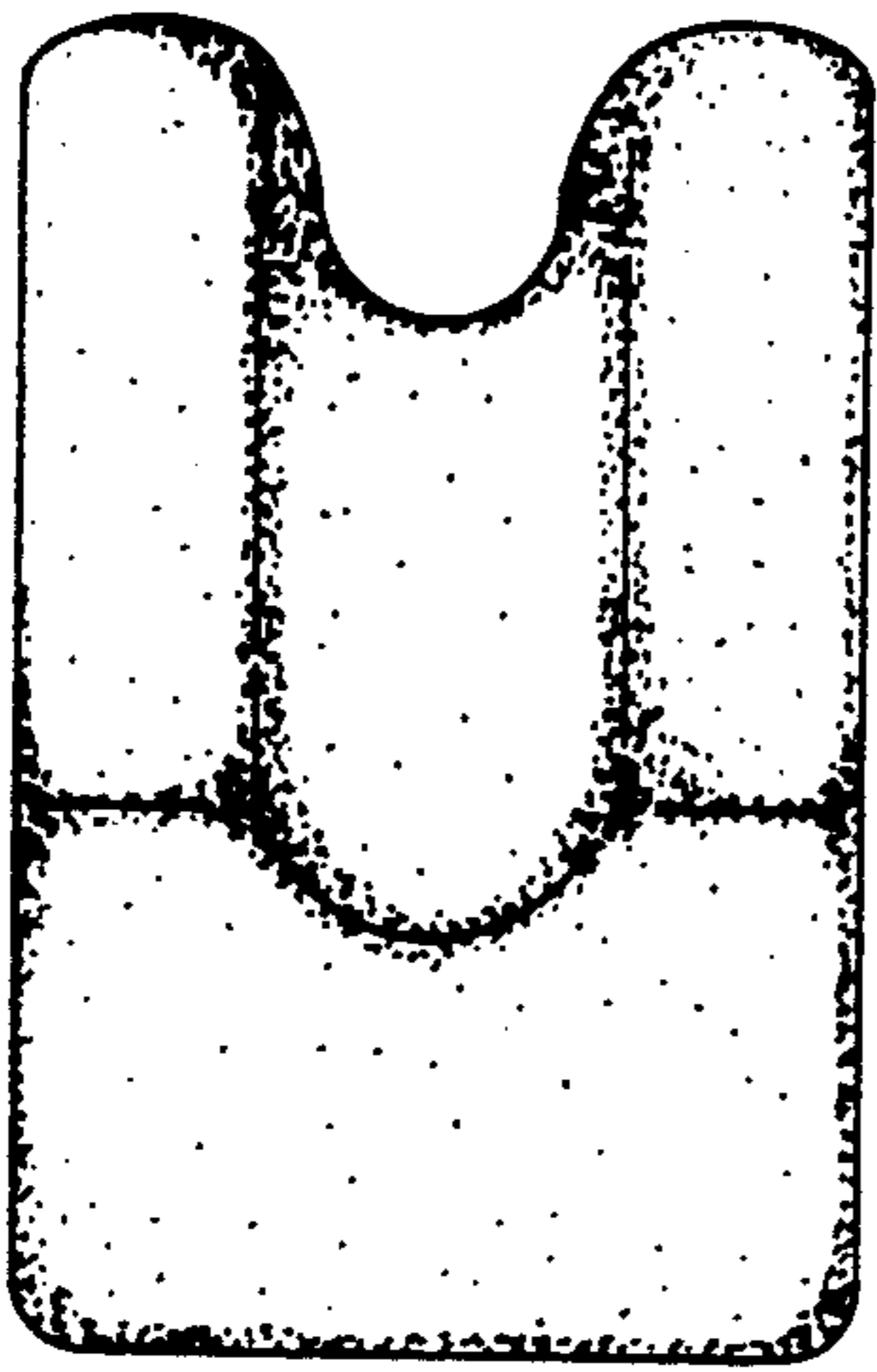

FIG. 7

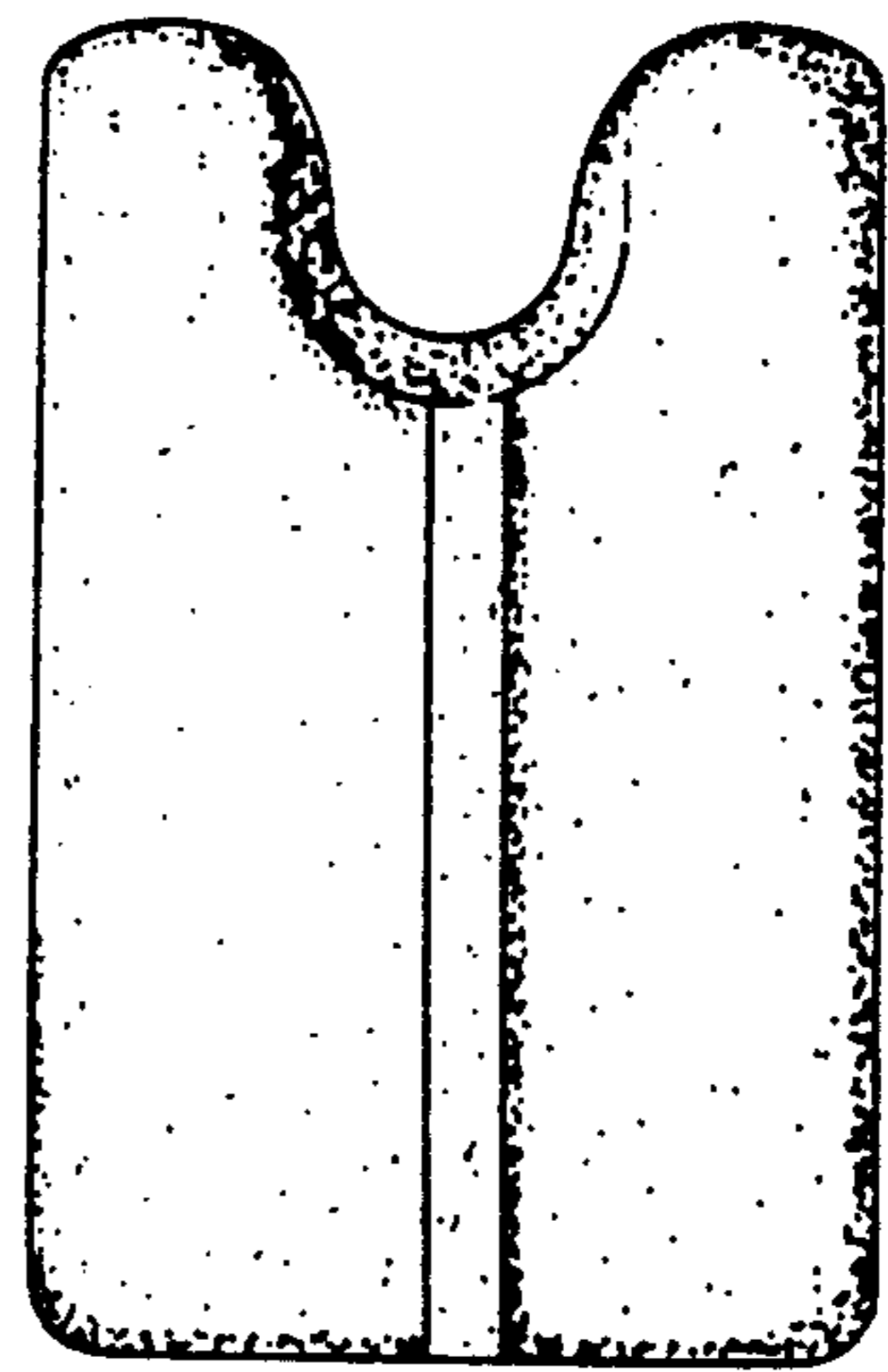

FIG. 8

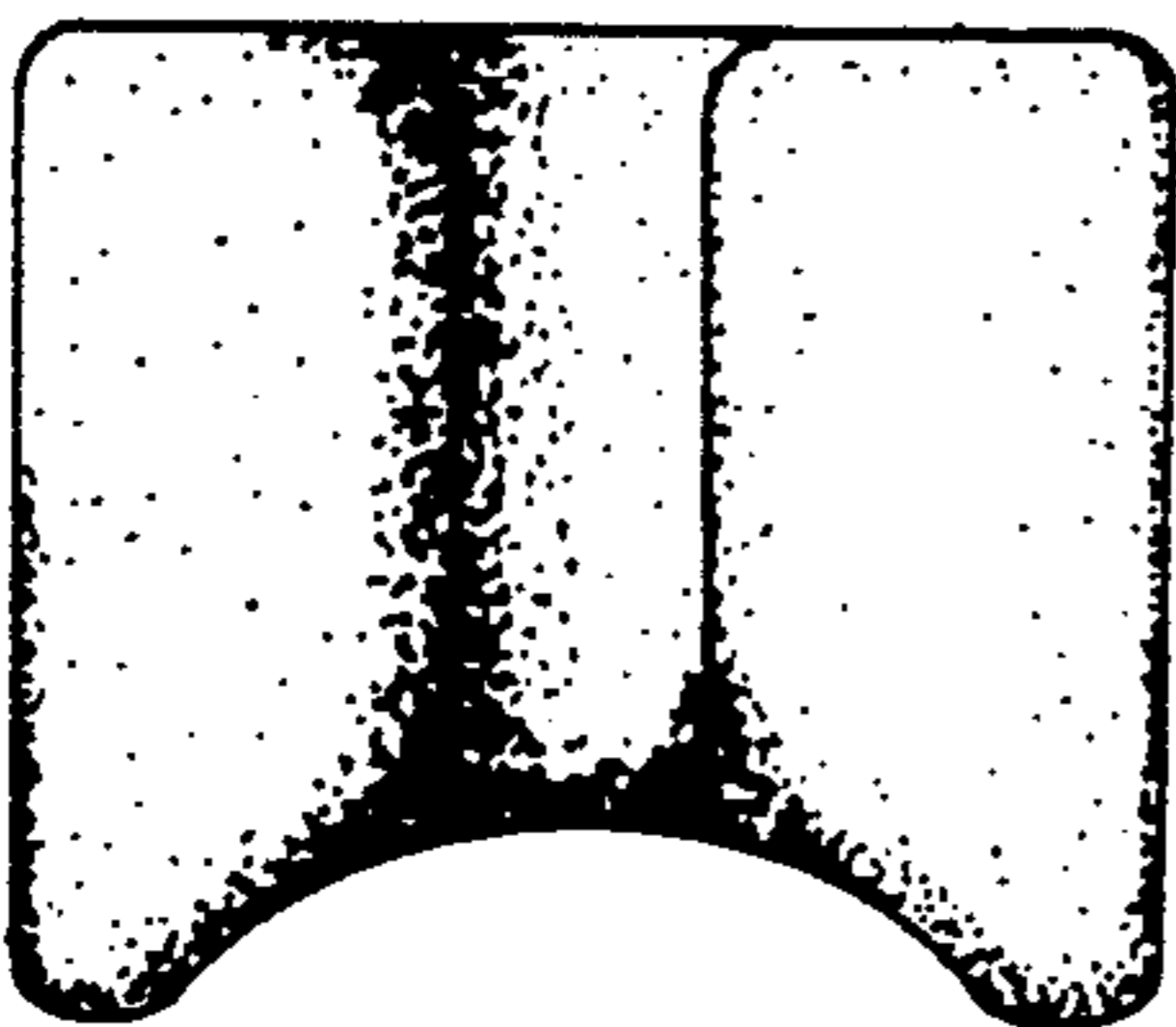

FIG. 9

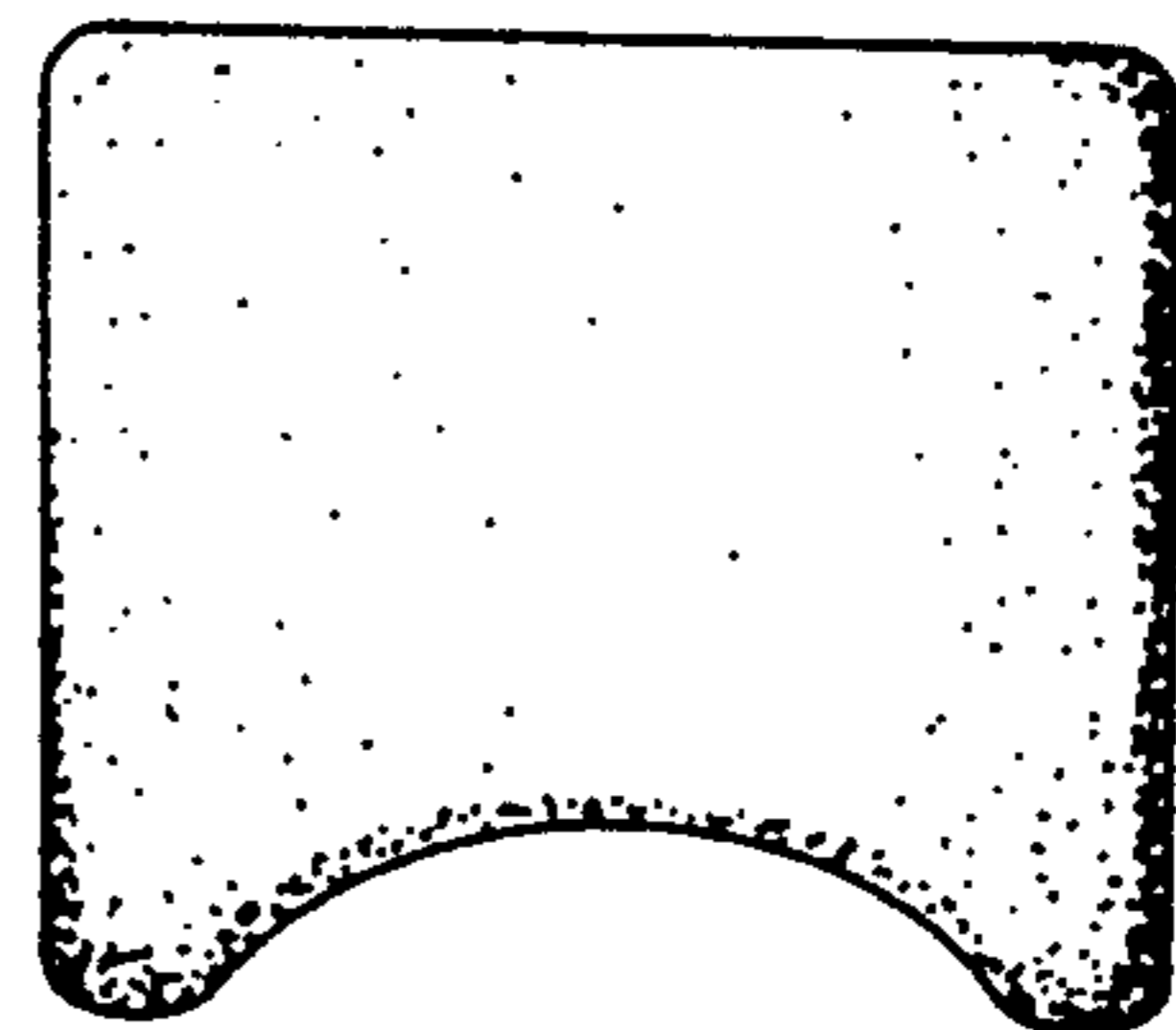

FIG. 10



FIG. 11

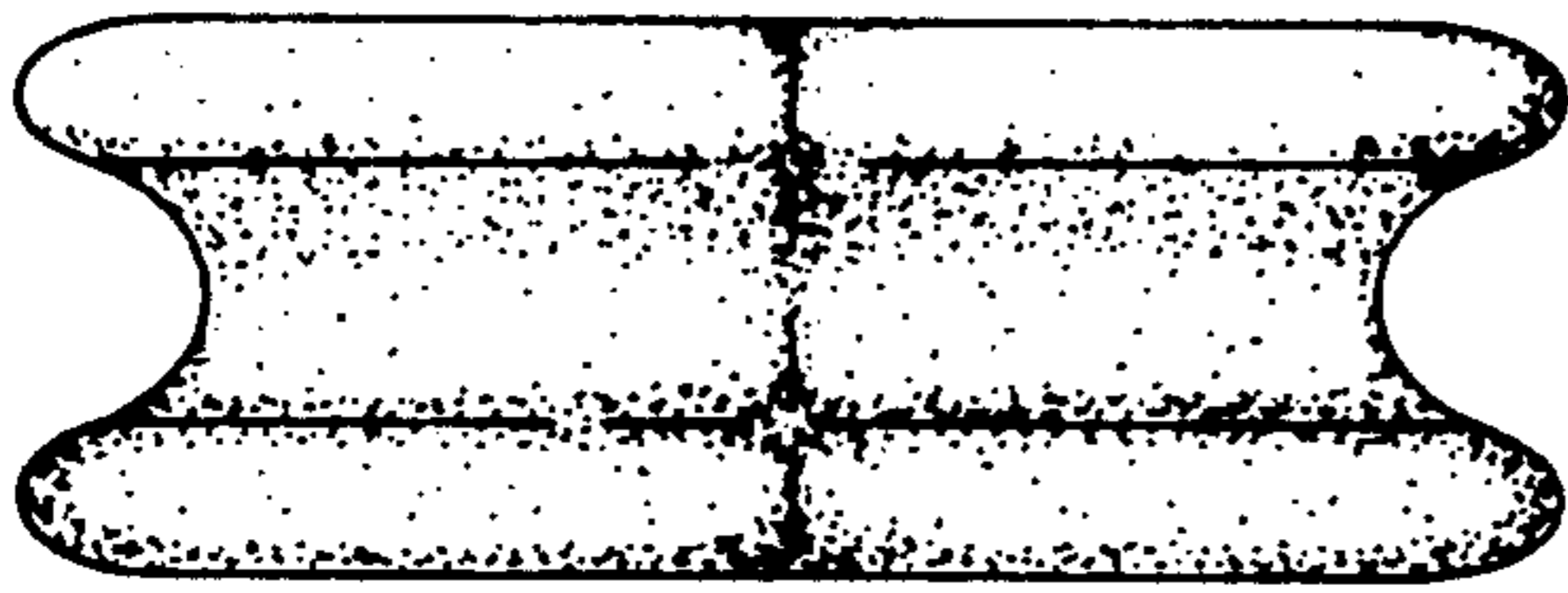

FIG. 12

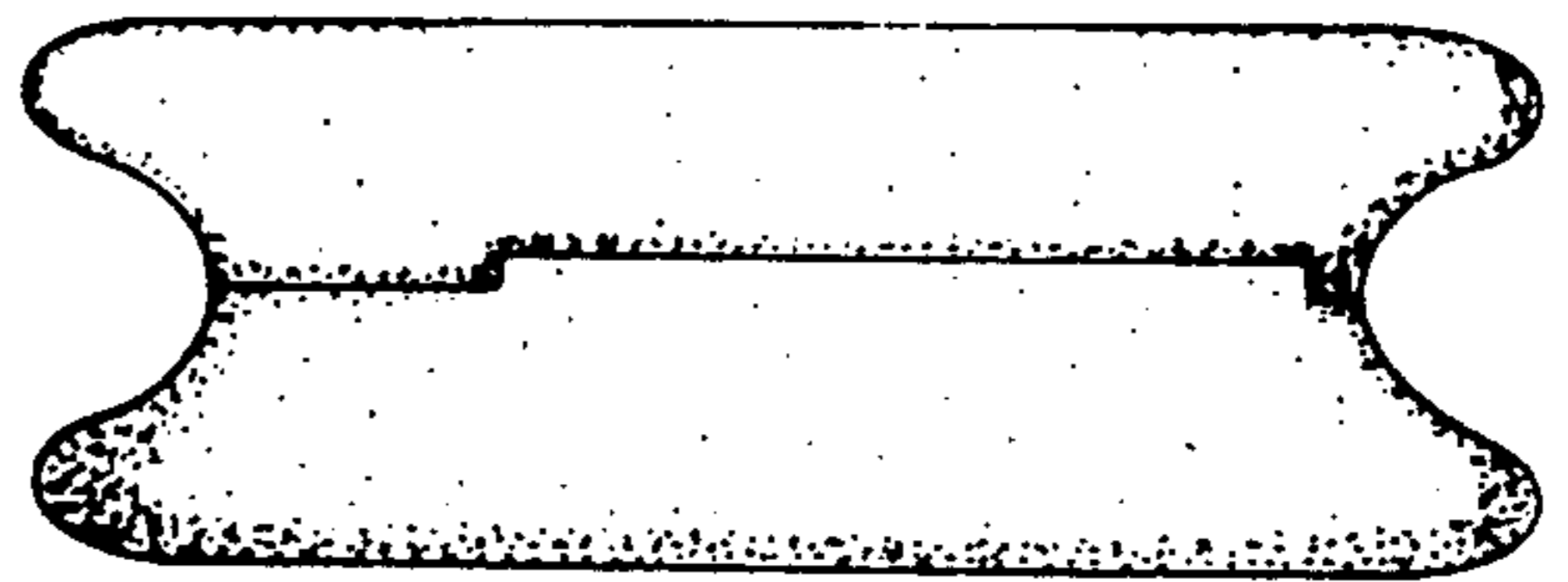

FIG. 13

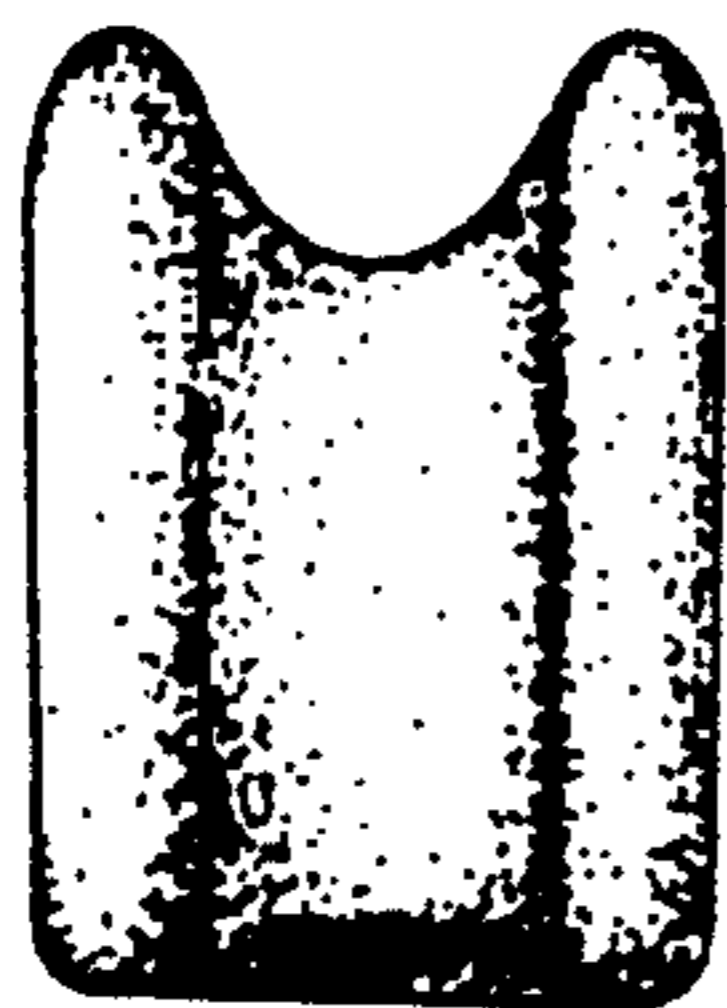

FIG. 14

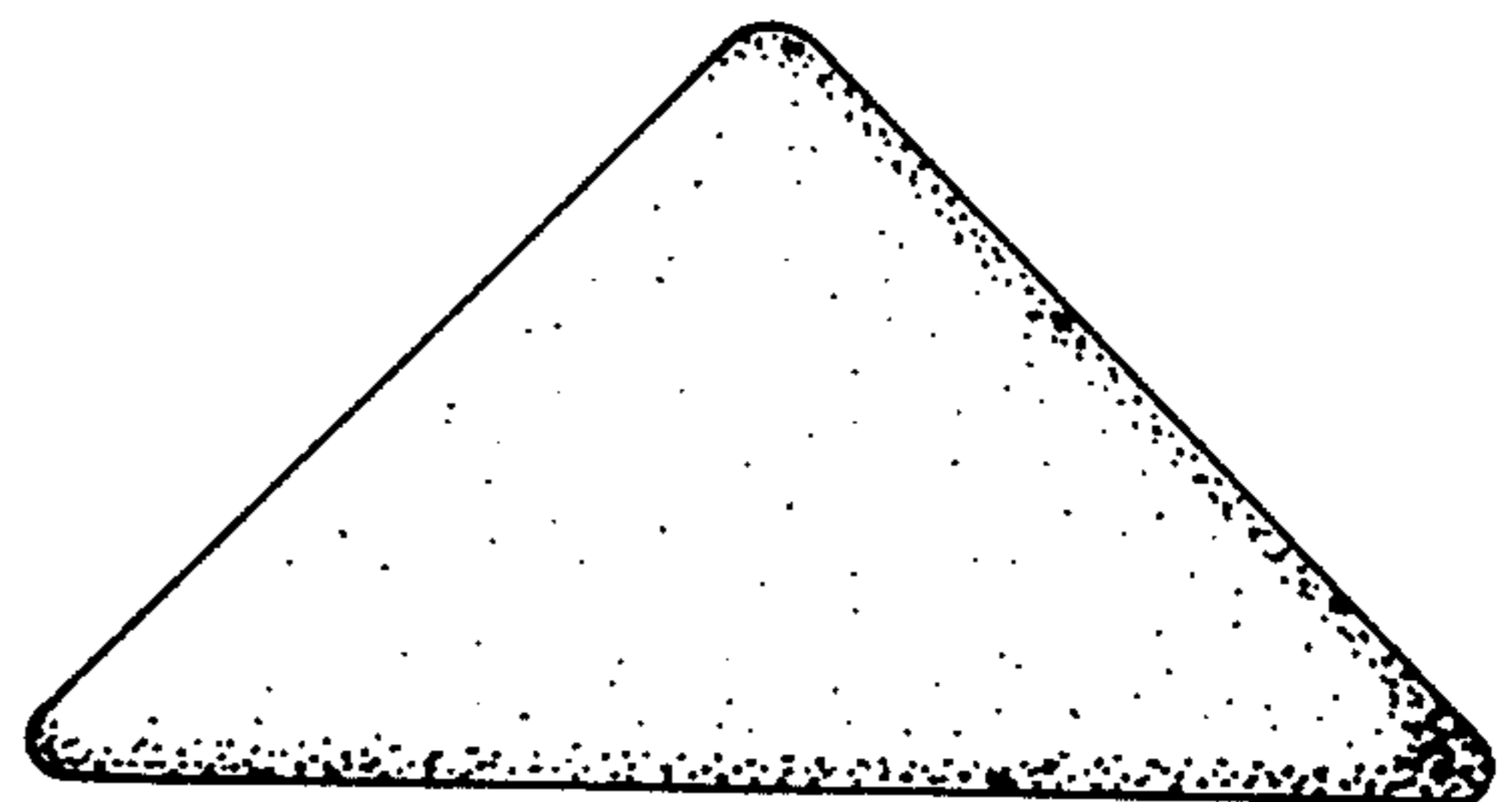

FIG. 15