



US00D342836S

# United States Patent [19]

[11] Patent Number: **Des. 342,836**

**Bennett**

[45] Date of Patent: **\*\* Jan. 4, 1994**

[54] CHAIR

[76] Inventor: **Ward Bennett, One W. 72nd St., New York, N.Y. 10023**

[\*] Notice: The portion of the term of this patent subsequent to Dec. 1, 2006 has been disclaimed.

[\*\*] Term: **14 Years**

[21] Appl. No.: **577,617**

[22] Filed: **Sep. 5, 1990**

[52] U.S. Cl. .... **D6/334**

[58] Field of Search ..... **D6/334, 371-376; 379, 380, 500p500-502, 370**

[56] **References Cited**

**U.S. PATENT DOCUMENTS**

- D. 199,621 11/1964 Johnson ..... D6/374
- D. 268,721 4/1983 Jernigan ..... D6/370

- D. 282,131 1/1986 Claman ..... D6/500
- D. 296,731 7/1988 Hollington ..... D6/379 X
- D. 331,329 12/1992 Bennett ..... D6/381

*Primary Examiner*—Nelson C. Holtje  
*Assistant Examiner*—J. E. Seeger  
*Attorney, Agent, or Firm*—Anthony D. Miller

[57] **CLAIM**

The ornamental design for a chair, as shown and described.

**DESCRIPTION**

FIG. 1 is a top plan view of a chair, showing my new design;  
FIG. 2 is a front elevational view;  
FIG. 3 is a bottom plan view;  
FIG. 4 is a left side elevational view;  
FIG. 5 is a right side elevational view;  
FIG. 6 is a rear elevational view; and,  
FIG. 7 is a perspective thereof.

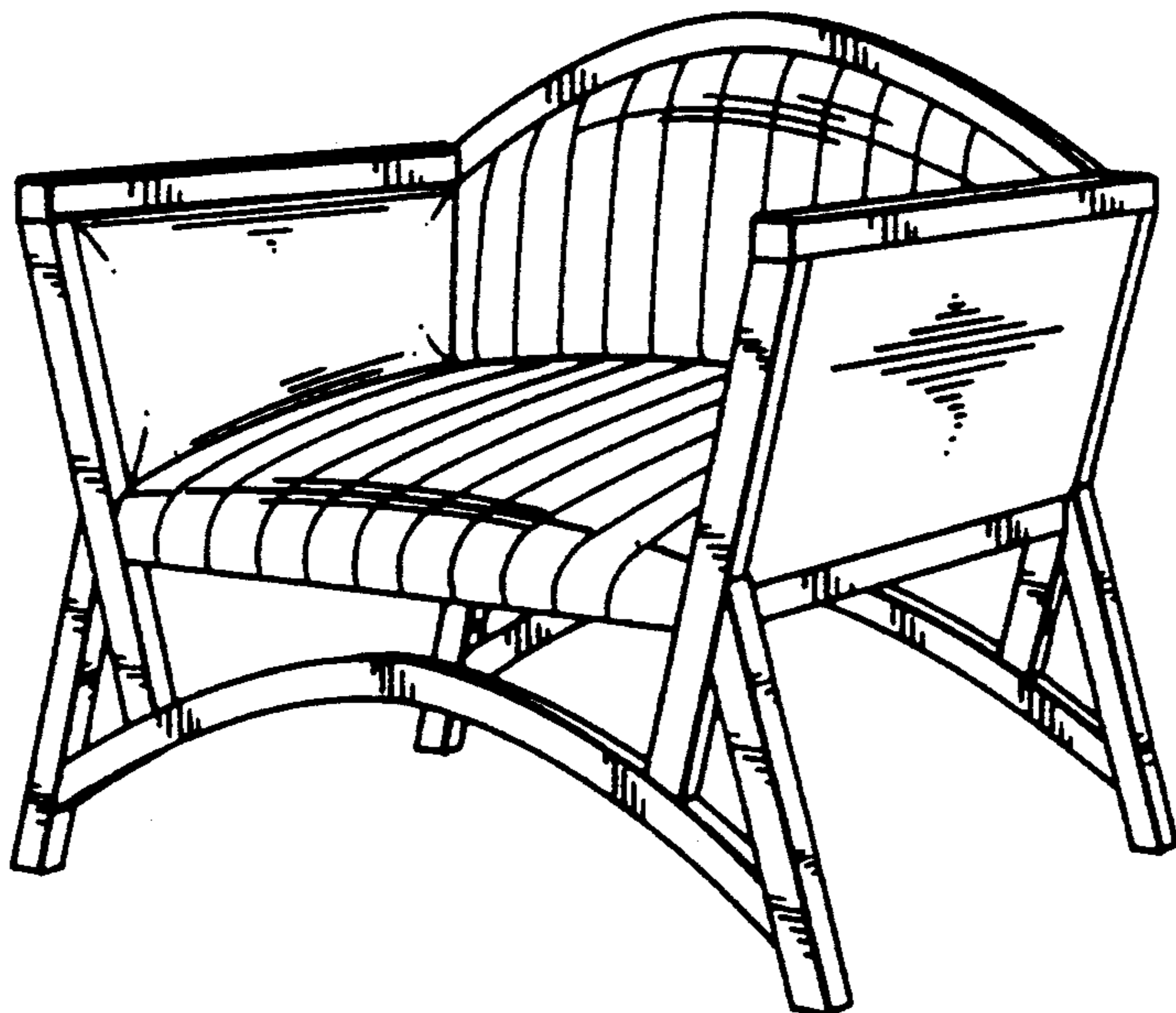

FIG. 1

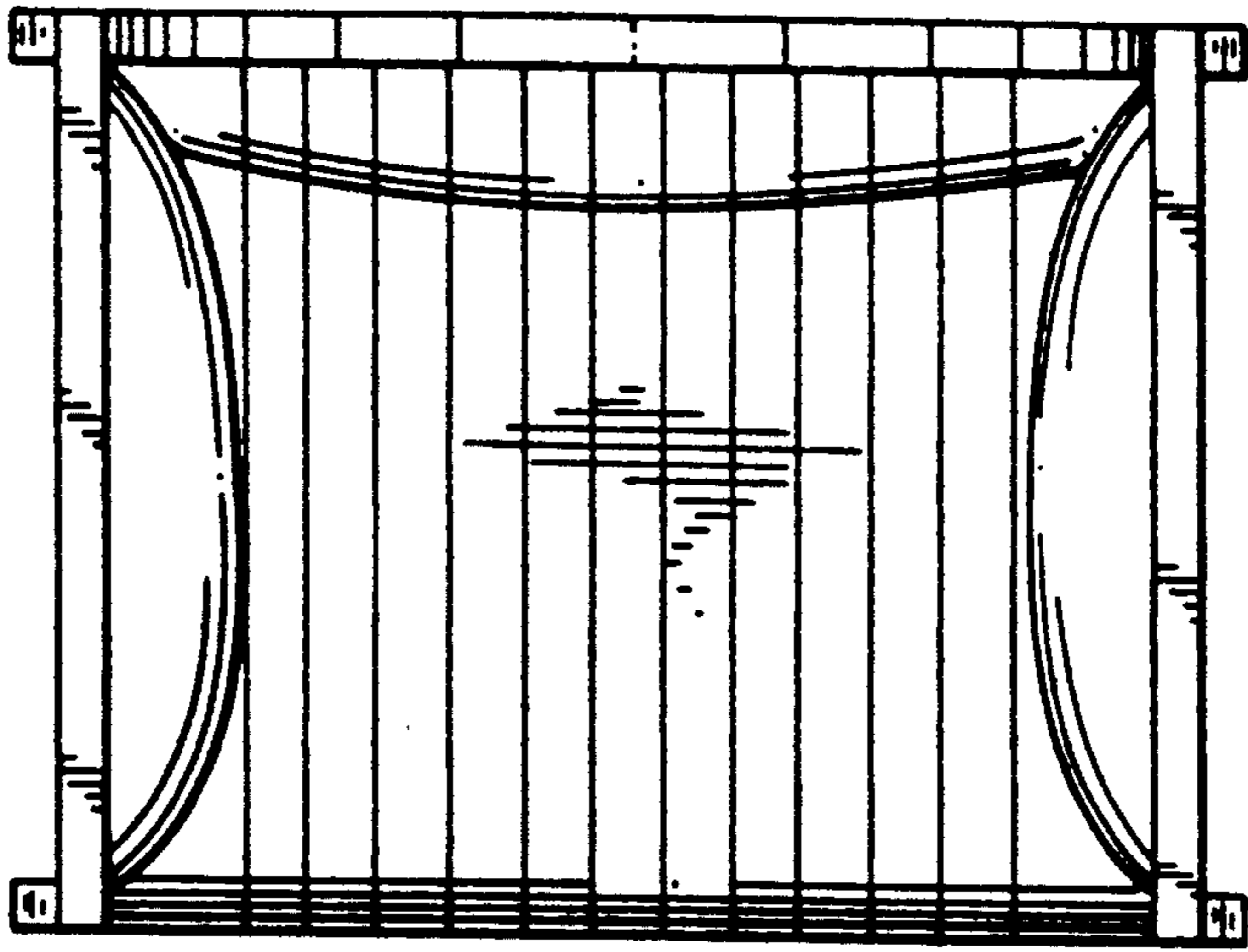

FIG. 2

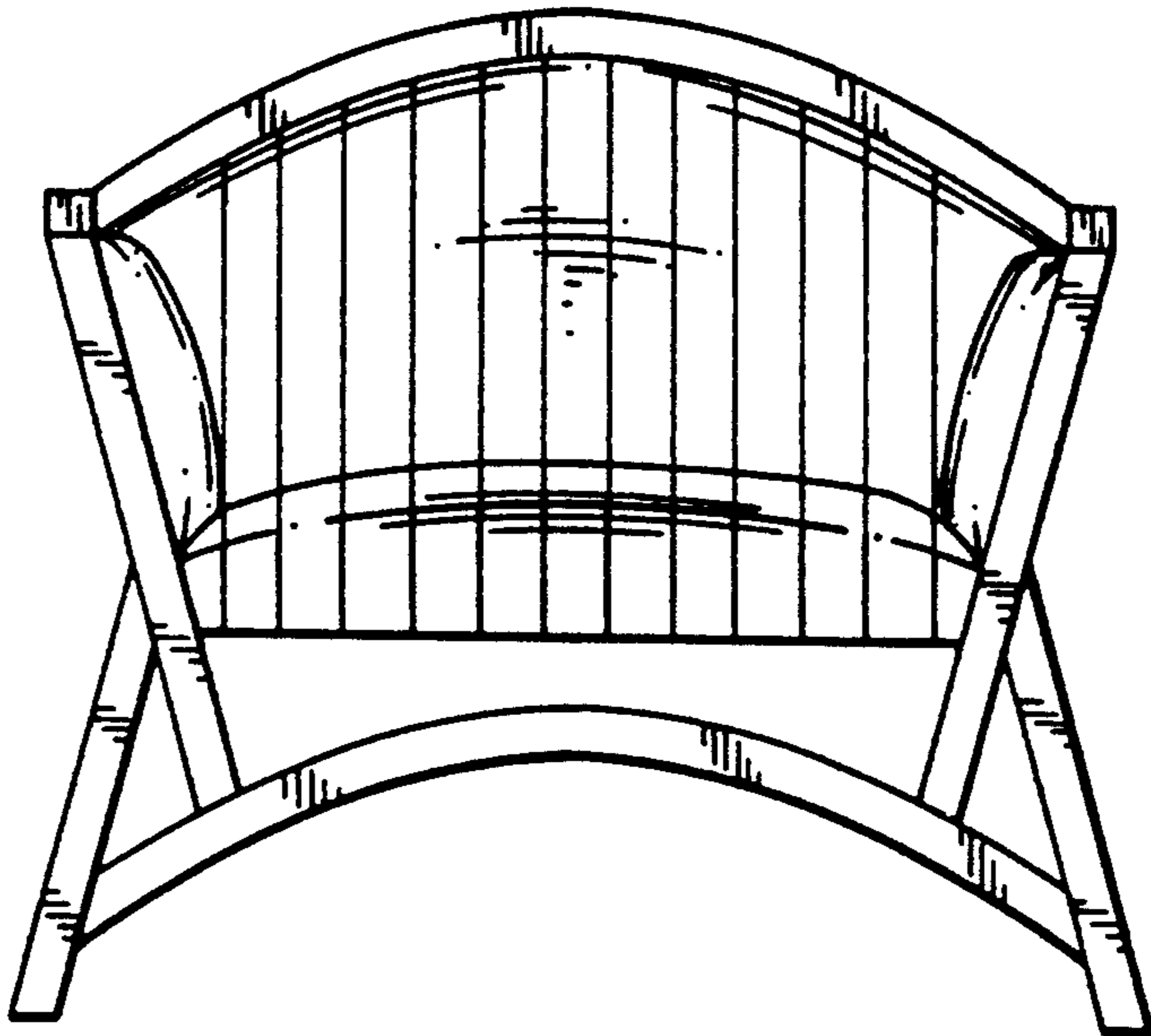
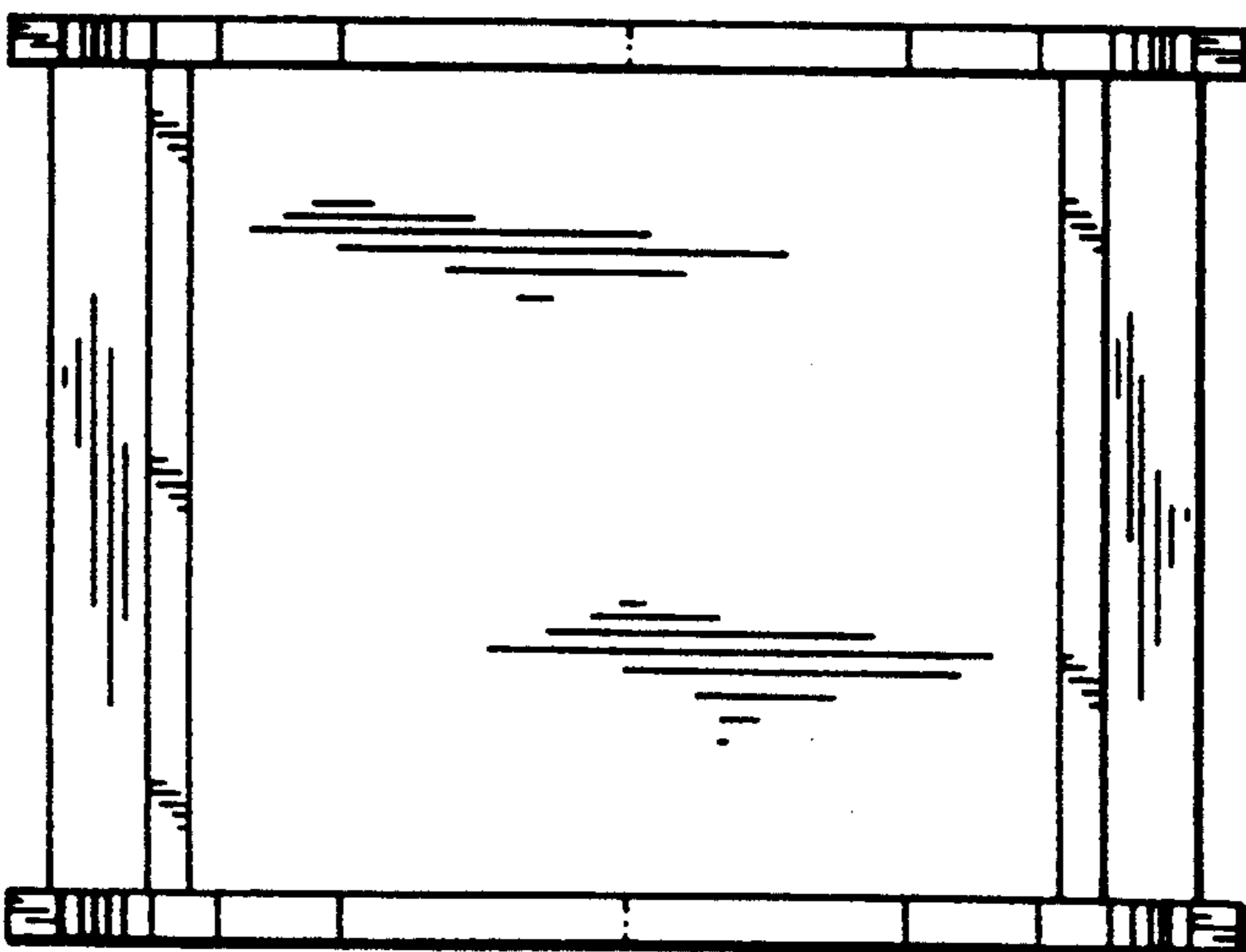

FIG. 3



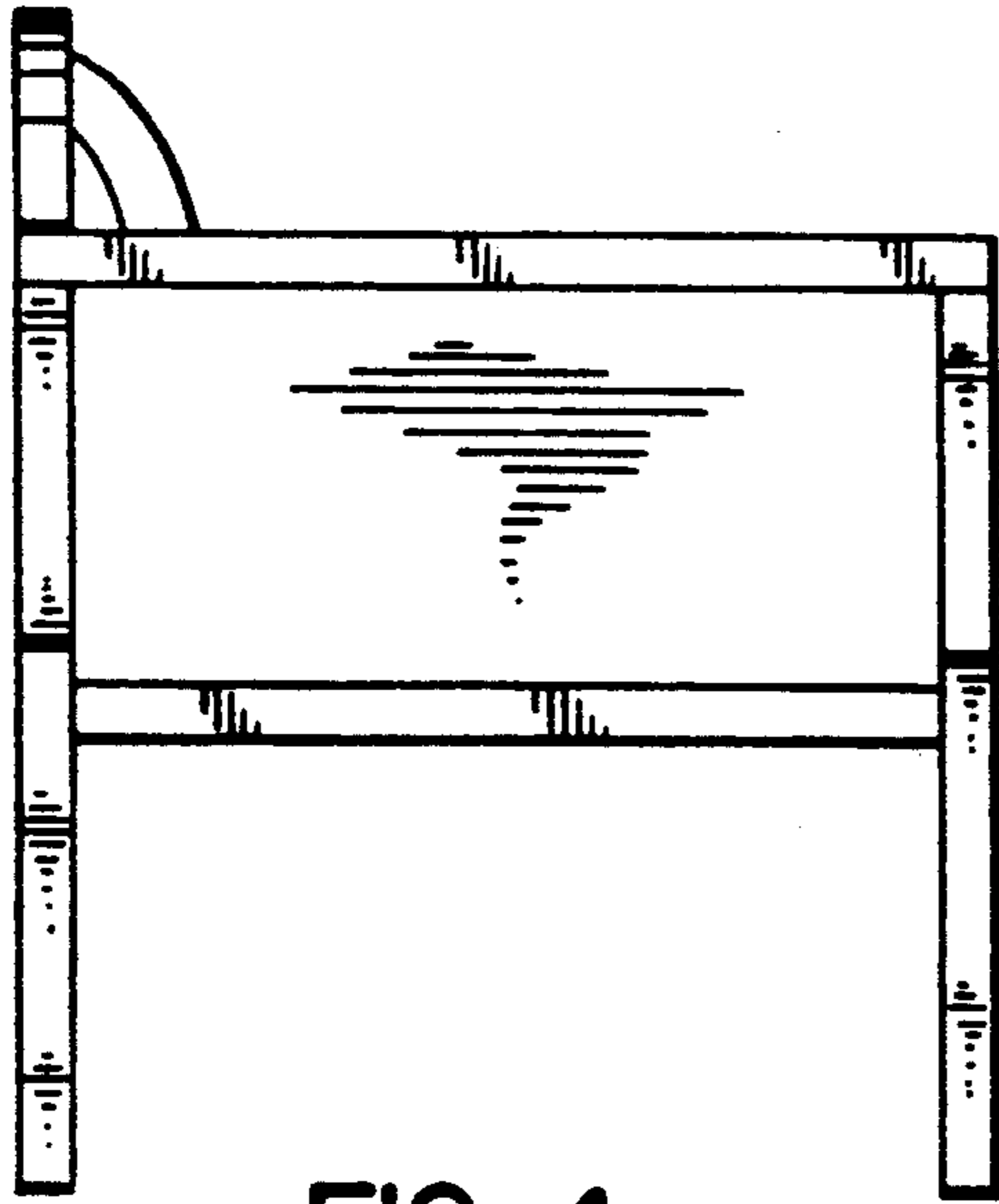

FIG. 4

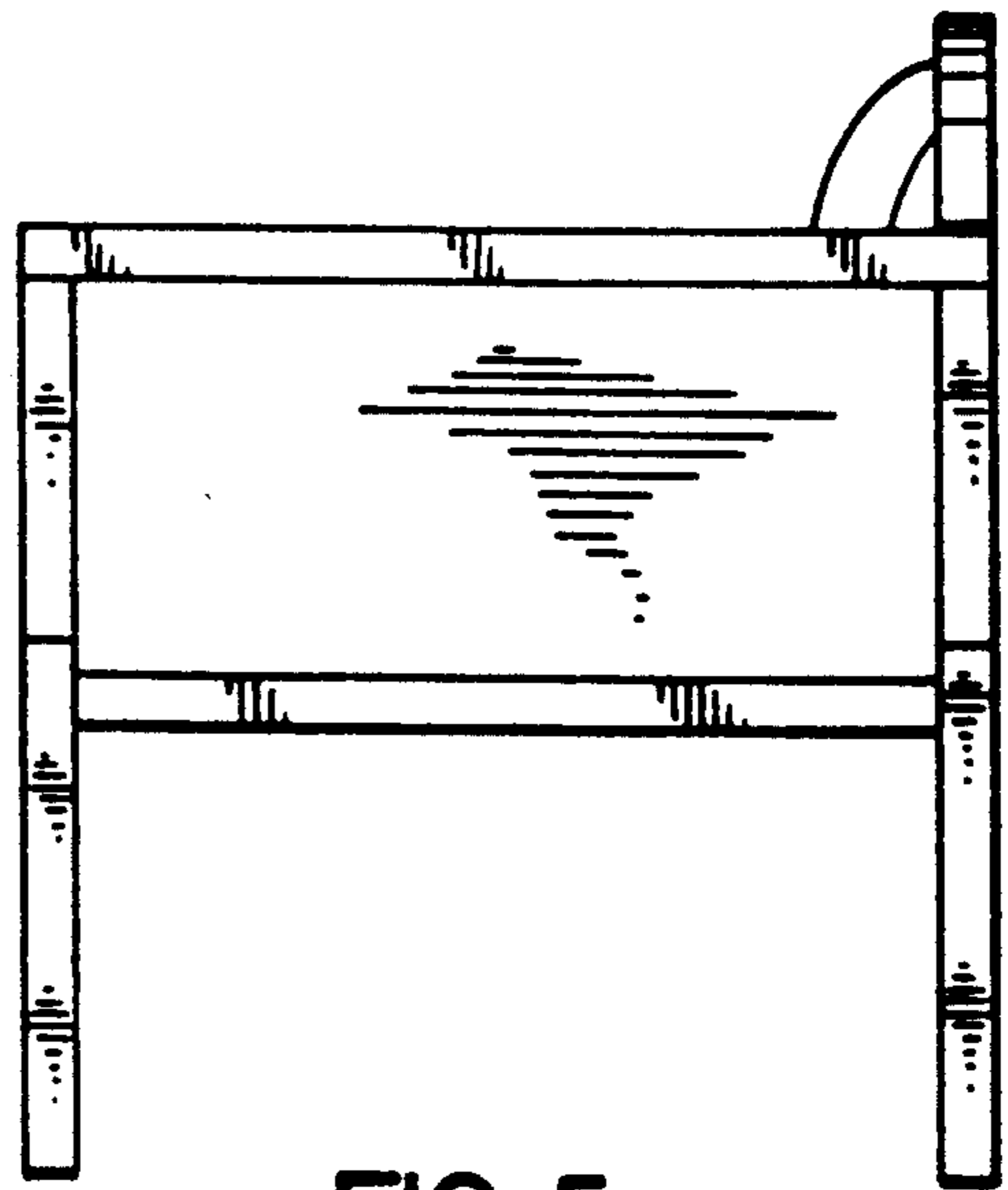

FIG. 5

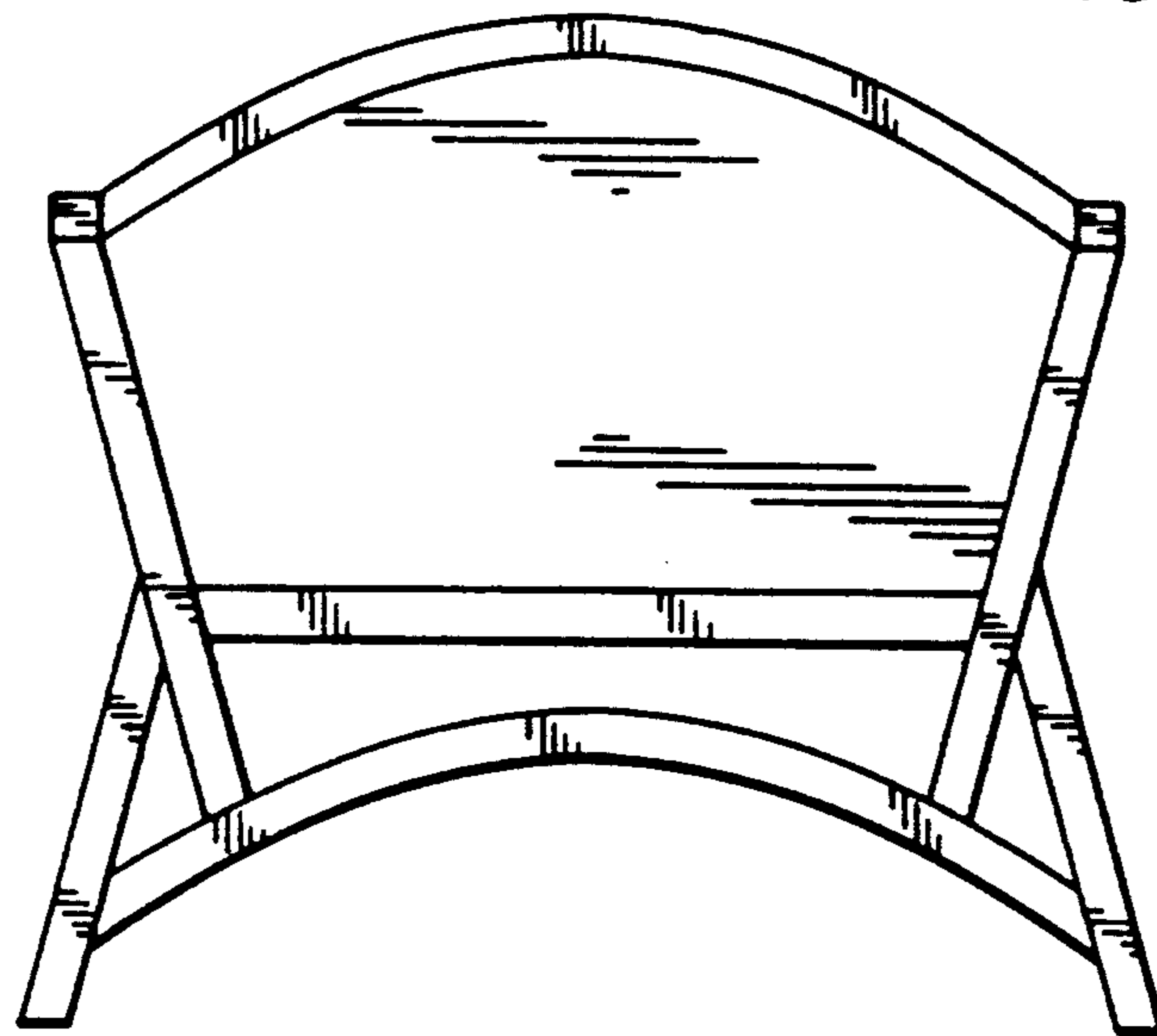

FIG. 6

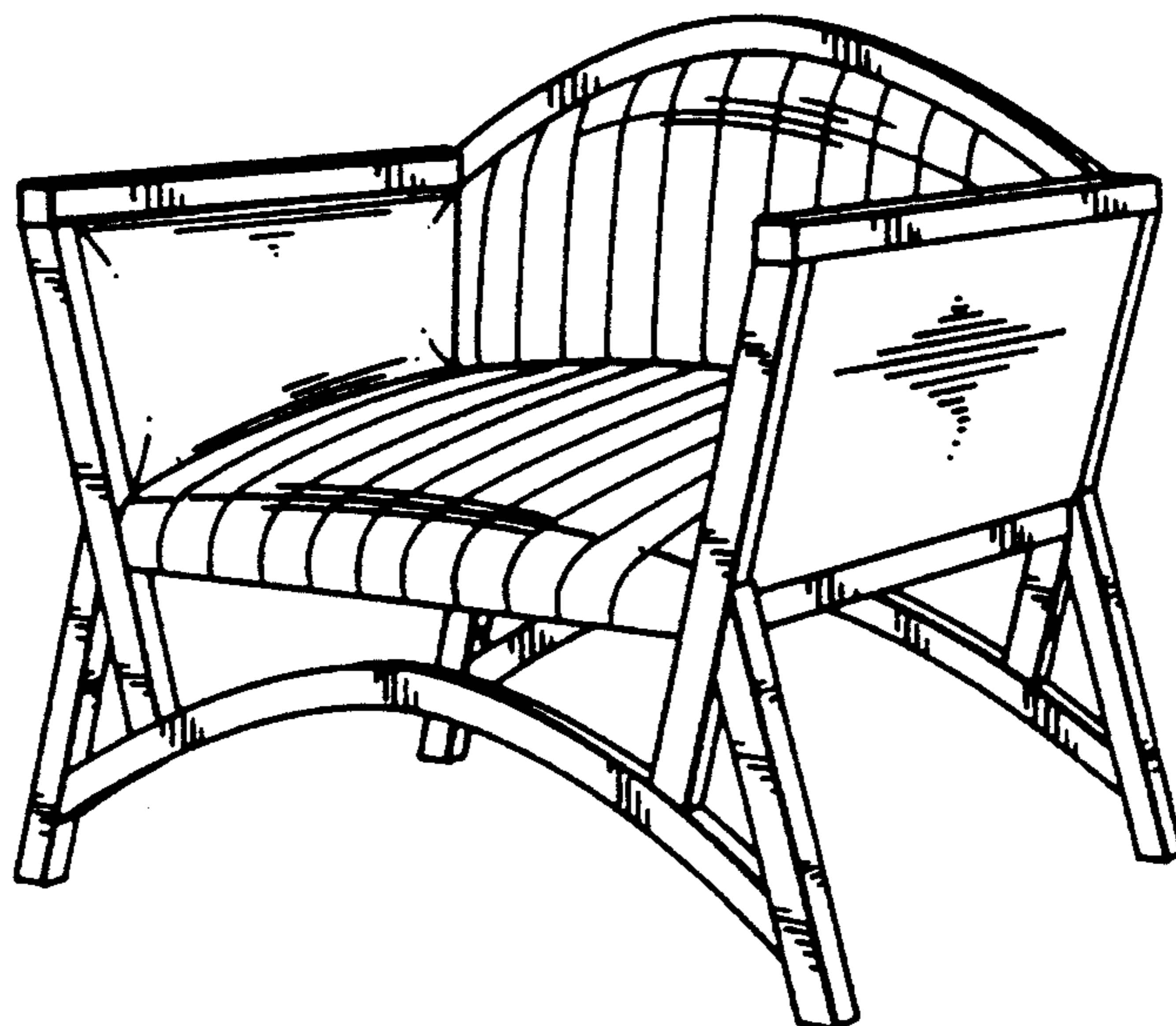

FIG. 7