



US00D342752S

United States Patent [19]

Urushihara et al.

[11] Patent Number: **Des. 342,752**

[45] Date of Patent: **** Dec. 28, 1993**

[54] **COMBINED VIDEO TAPE RECORDER AND CAMERA**

[75] Inventors: **Atsuhiko Urushihara, Tokyo;**
Masami Mizuno, Katsuta, both of
Japan

[73] Assignee: **Hitachi, Ltd., Tokyo, Japan**

[**] Term: **14 Years**

[21] Appl. No.: **953,595**

[22] Filed: **Sep. 30, 1992**

[30] **Foreign Application Priority Data**

May 15, 1992 [JP] Japan 4-13915

[52] U.S. Cl. **D16/202**

[58] Field of Search **D16/200-205,**
D16/208; 352/34, 242, 243; 354/82, 288;
358/229, 906

[56] **References Cited**

U.S. PATENT DOCUMENTS

D. 288,811 3/1987 Kurokawa et al. D16/202
D. 294,570 3/1988 Kurokawa et al. D16/202

D. 323,519 1/1992 Fukuda D16/202
D. 332,958 2/1993 Urushihara et al. D16/202
4,772,902 9/1988 Inoue et al. 358/229

OTHER PUBLICATIONS

Canon Catalog, Oct. 1990 p. 7.

Primary Examiner—Bernard Ansher
Assistant Examiner—Adir Aronovich
Attorney, Agent, or Firm—Antonelli, Terry, Stout & Kraus

[57] **CLAIM**

The ornamental design for a combined video tape recorder and camera, as shown.

DESCRIPTION

FIG. 1 is a front, top and right side perspective view of a combined video tape recorder and camera showing our new design;
FIG. 2 is a front elevational view thereof;
FIG. 3 is a rear elevational view thereof;
FIG. 4 is a right side elevational view thereof;
FIG. 5 is a left side elevational view thereof;
FIG. 6 is a top plan view thereof; and,
FIG. 7 is a bottom plan view thereof.

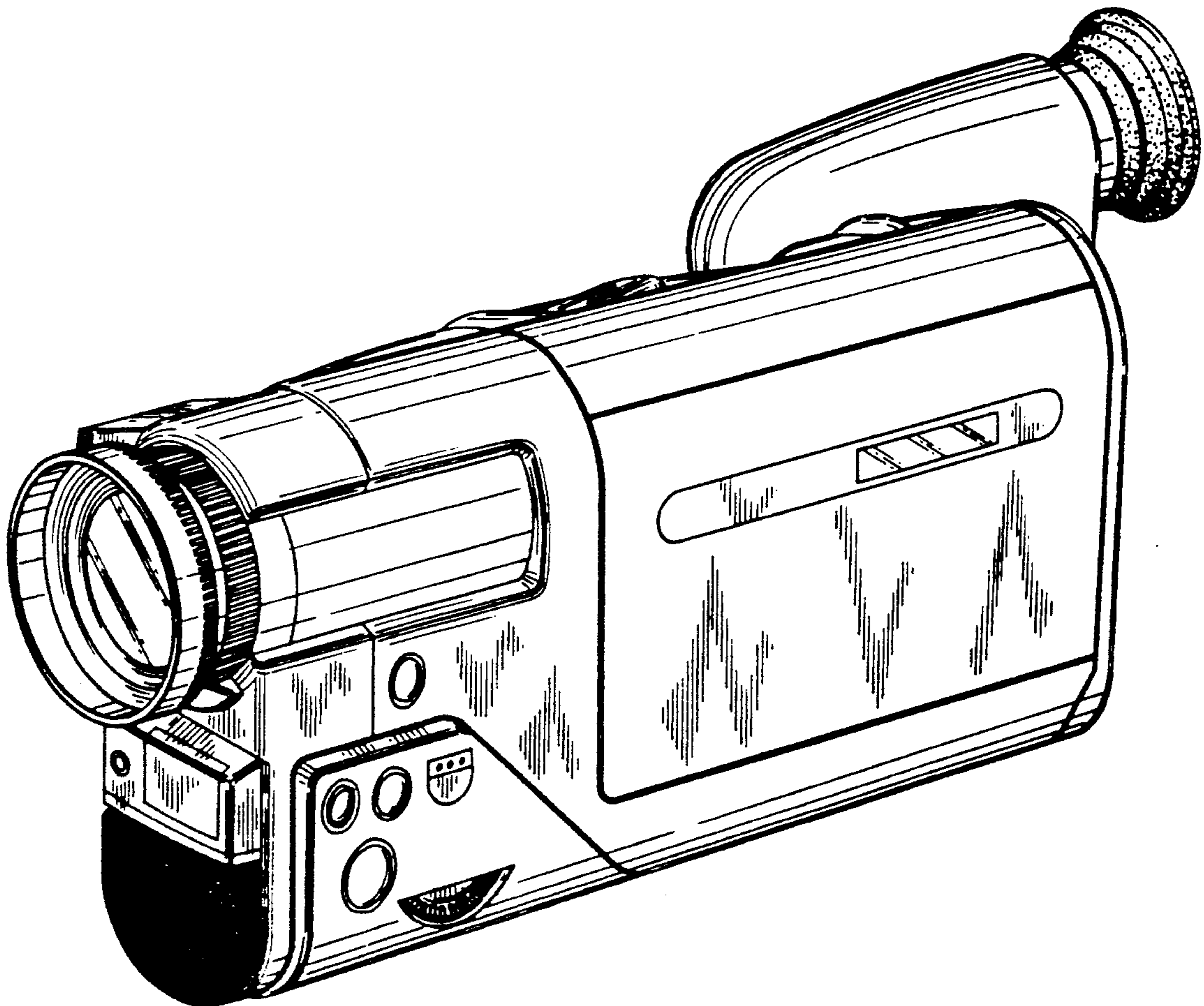

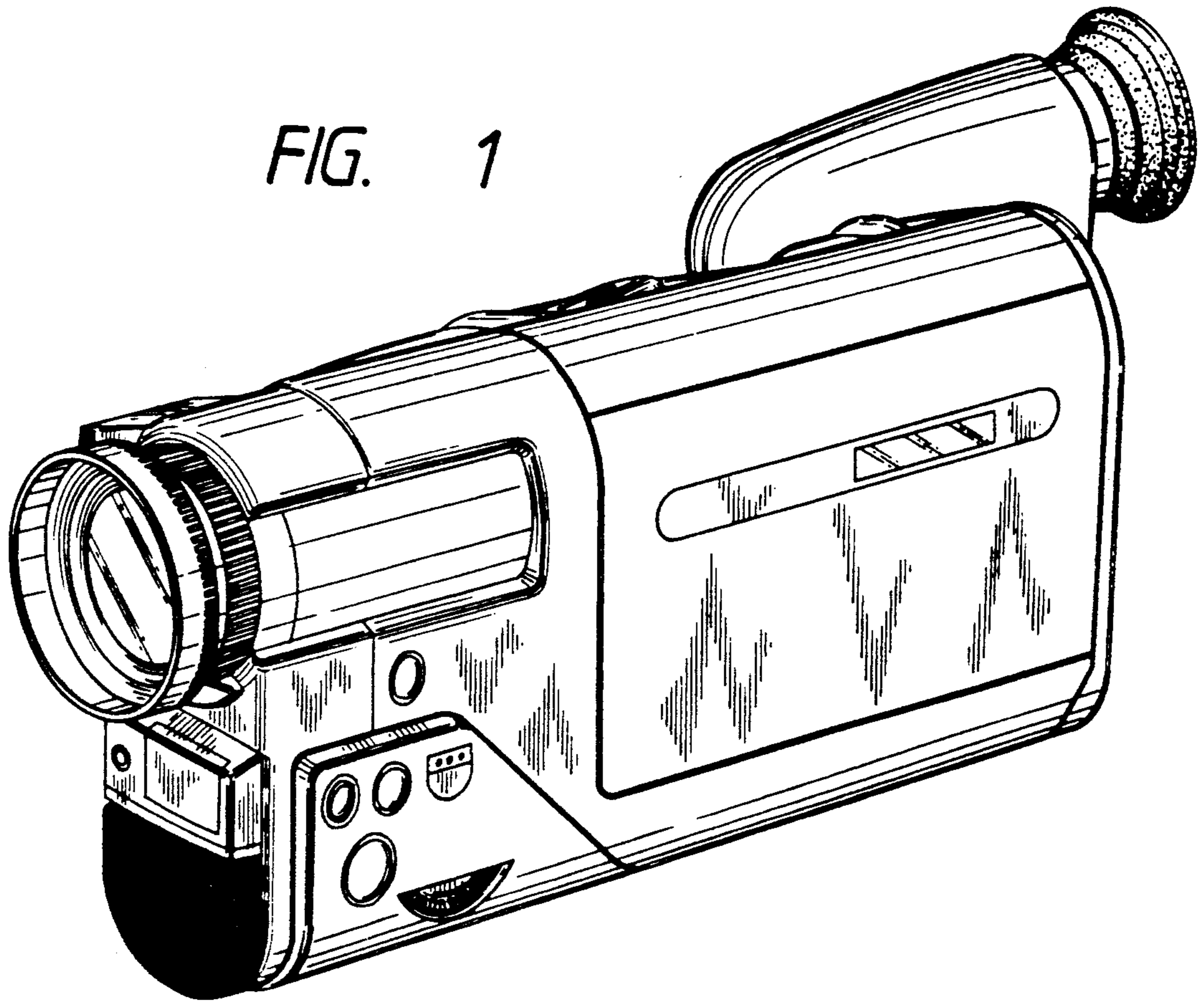

FIG. 2

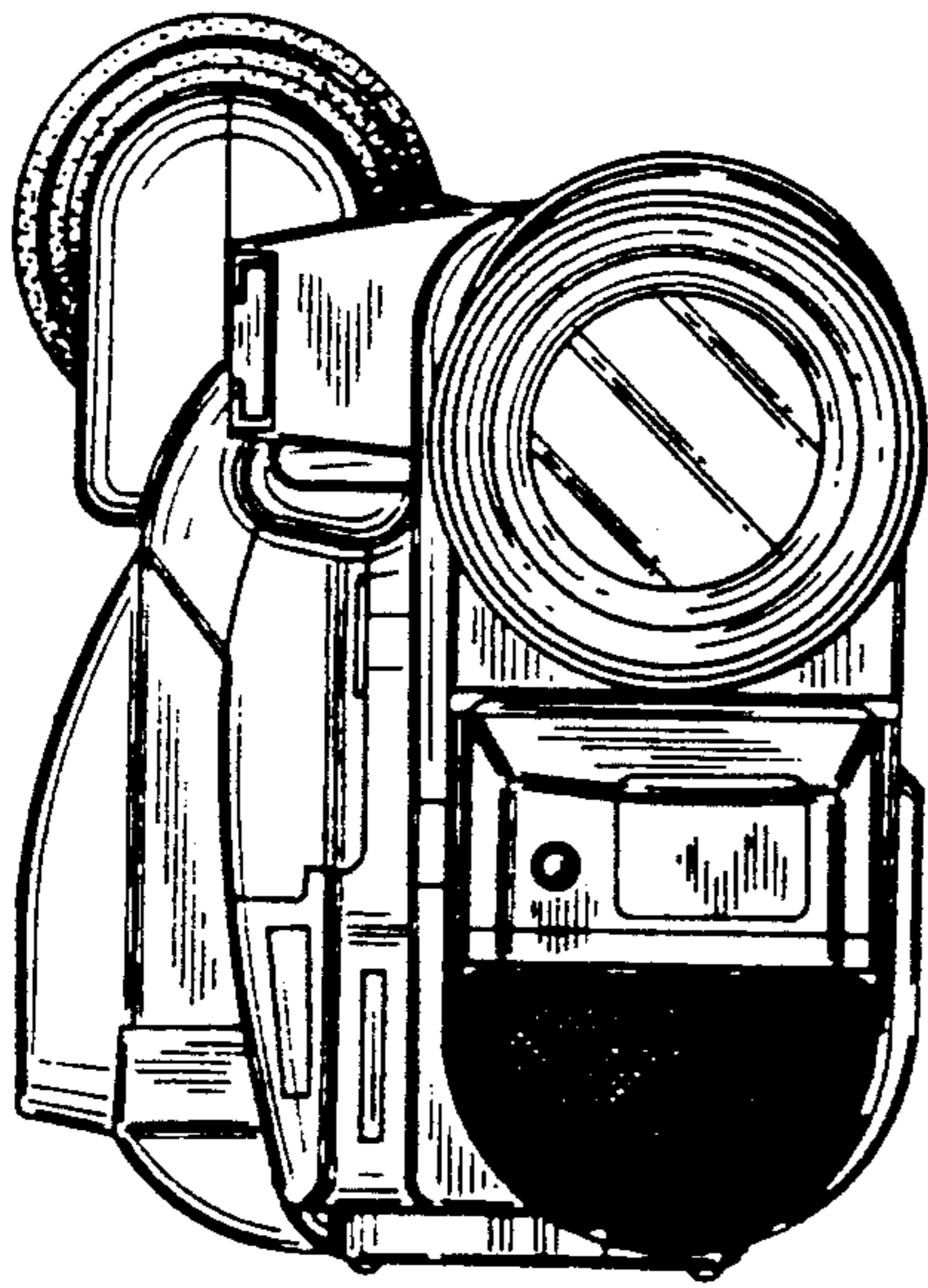

FIG. 3

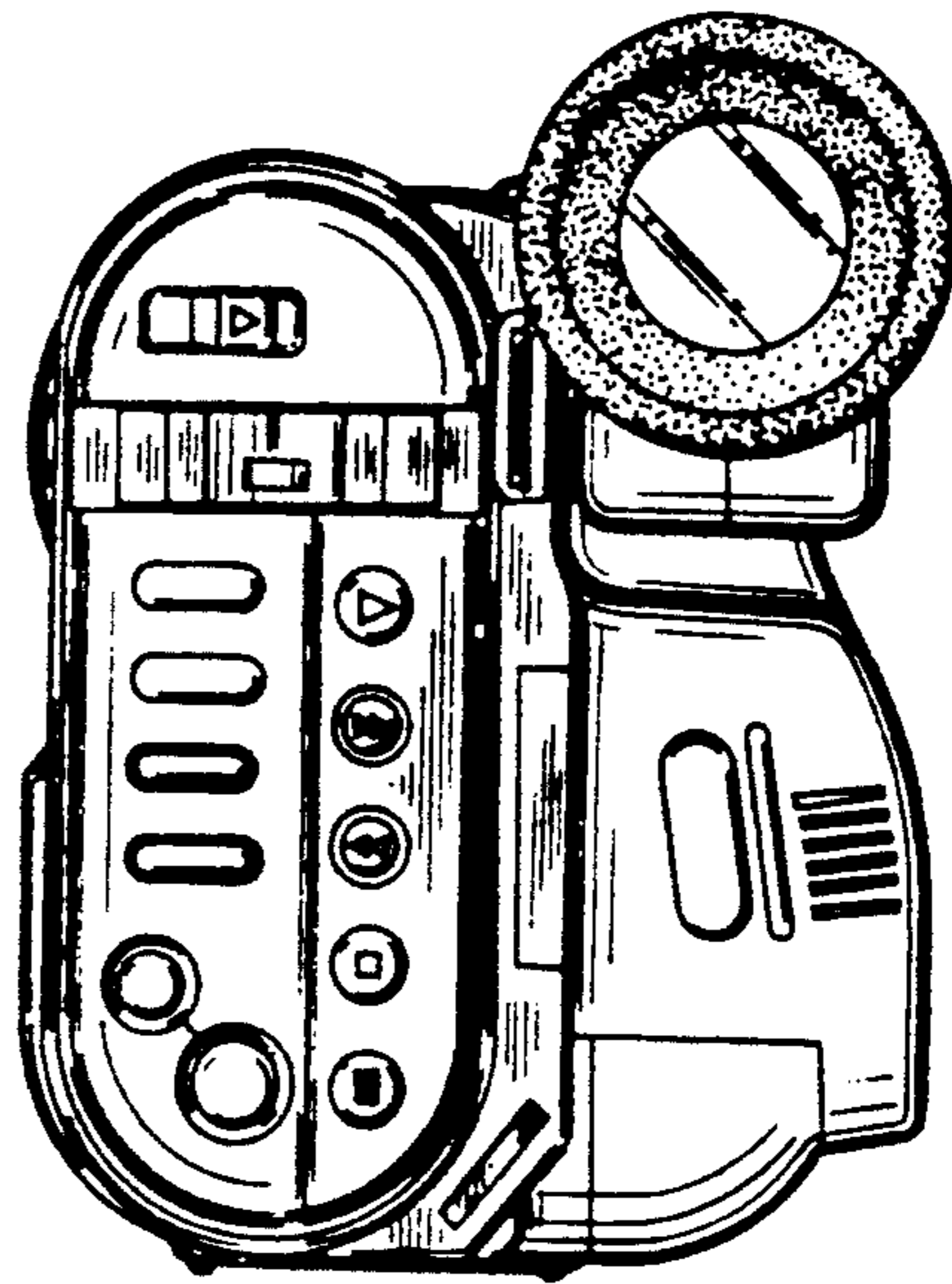

FIG. 4

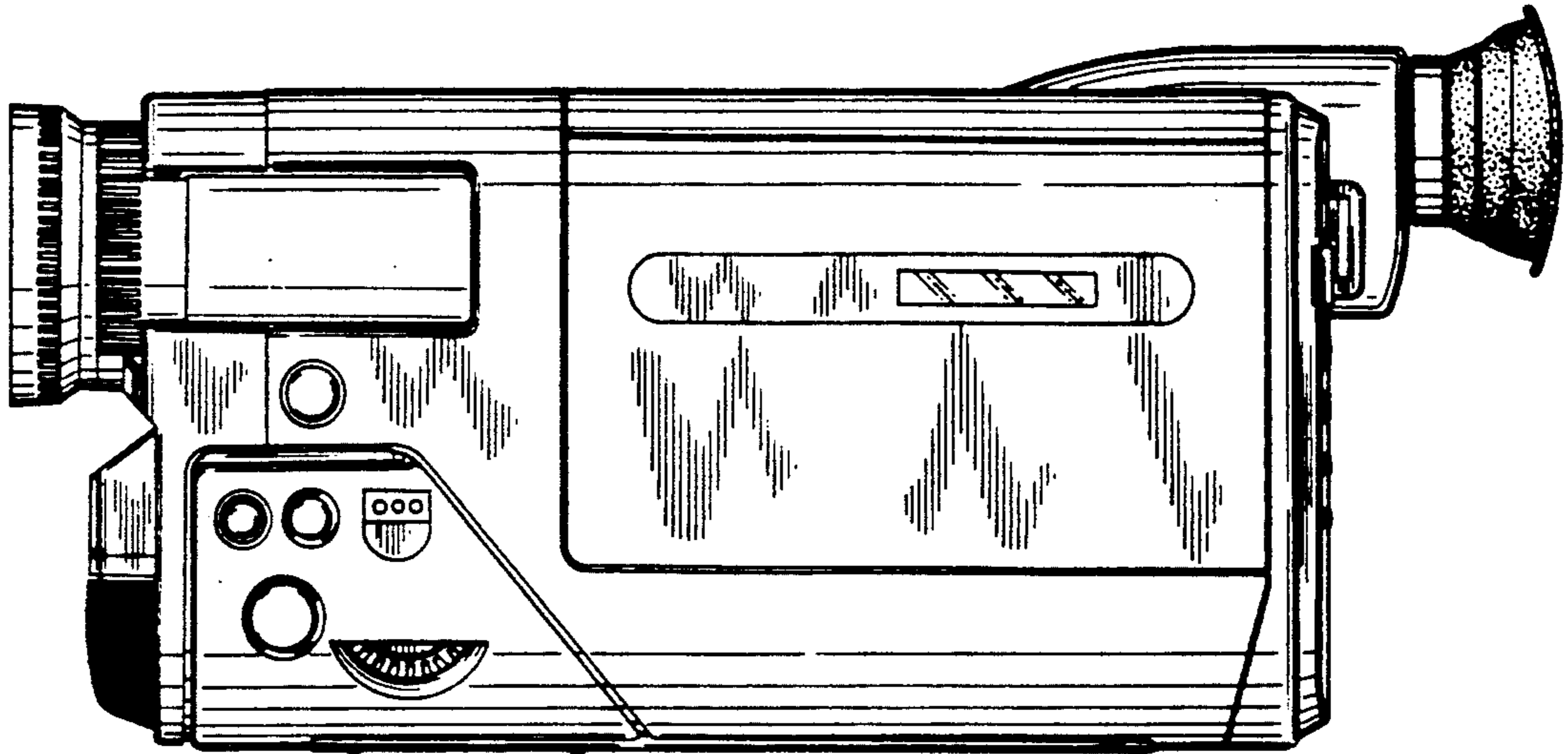

FIG. 5

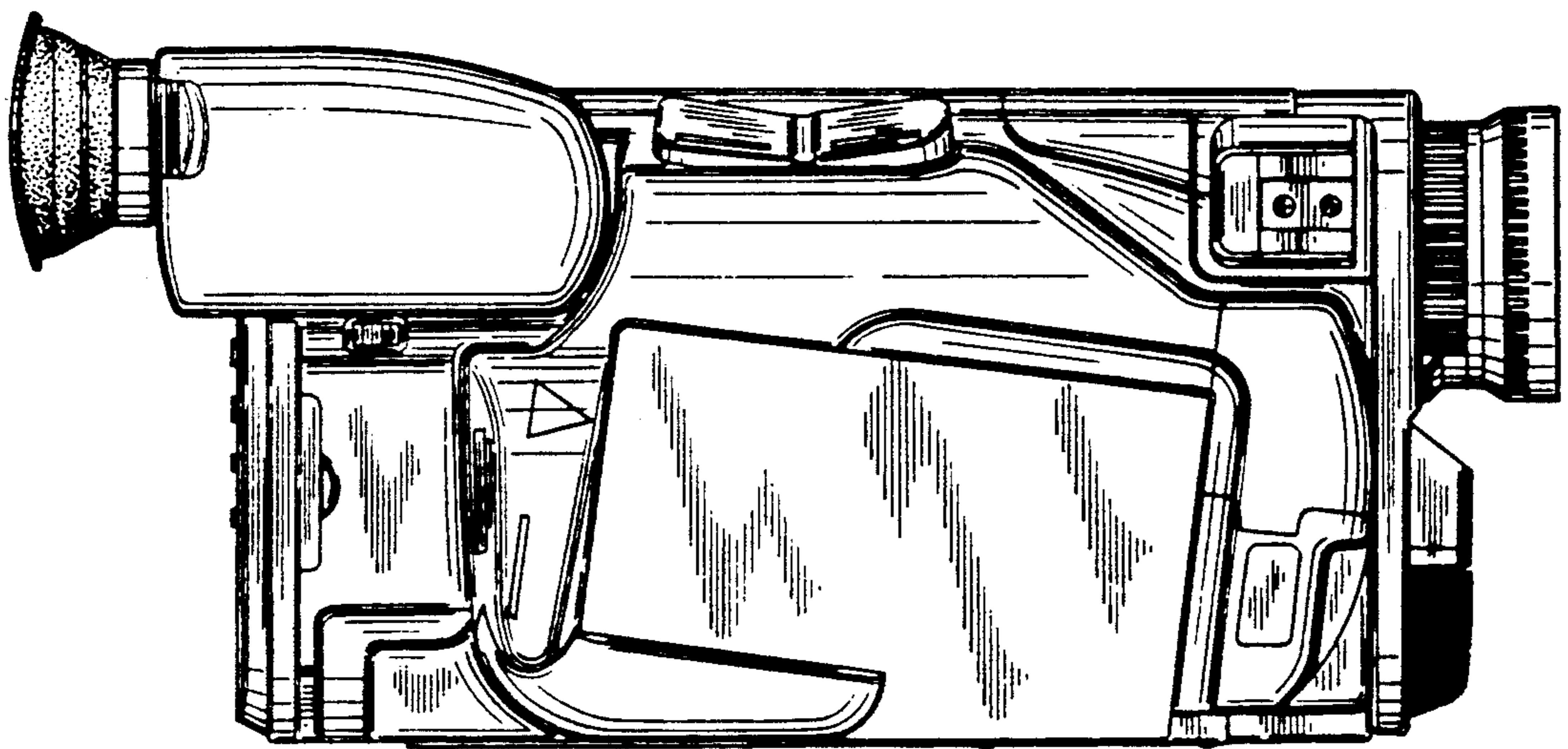

FIG. 6

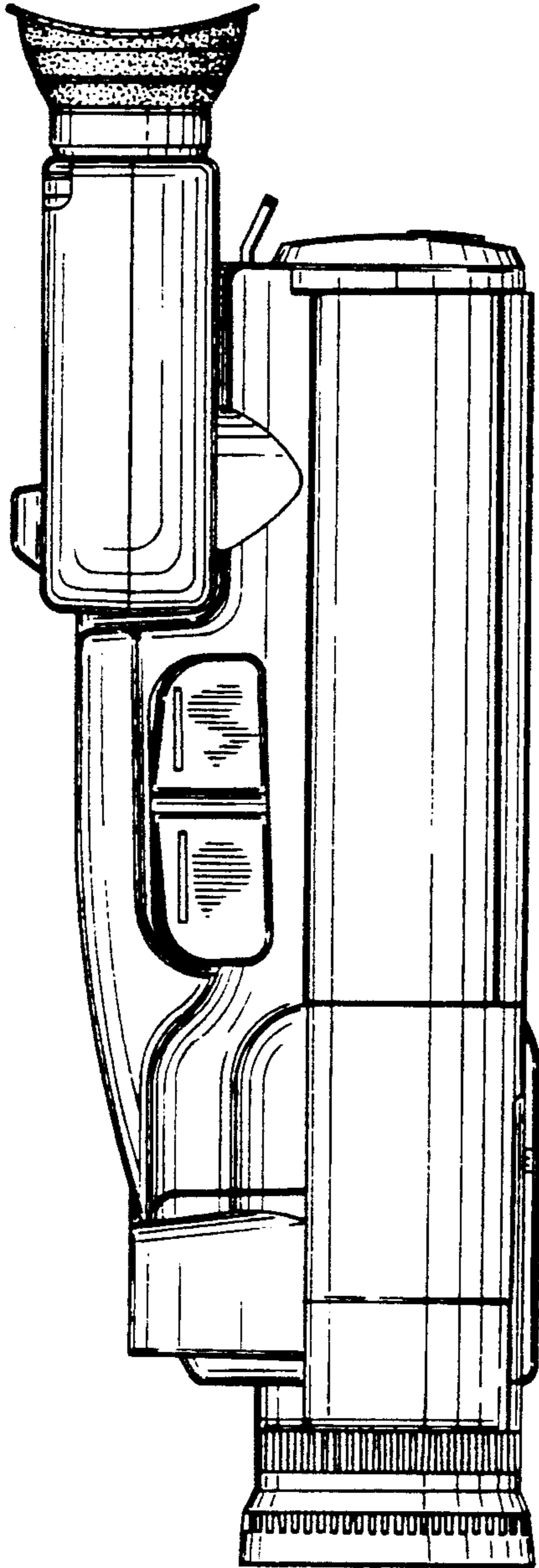

FIG. 7

