



US00D342700S

United States Patent [19]

Vernese

[11] Patent Number: Des. 342,700

[45] Date of Patent: ** Dec. 28, 1993

[54] HORSE TRAILER

[75] Inventor: Michael P. Vernese, Boynton Beach, Fla.

[73] Assignee: Prolite, Inc., Peculiar, Mo.

[**] Term: 14 Years

[21] Appl. No.: 780,311

[22] Filed: Oct. 22, 1991

[52] U.S. Cl. D12/102

[58] Field of Search D12/103, 104;
280/415.1, 416.1, 475; 296/168

[56] **References Cited**

U.S. PATENT DOCUMENTS

| | | | | |
|------------|---------|---------|-------|---------|
| D. 267,710 | 1/1983 | King | | D12/103 |
| 3,770,297 | 11/1973 | Quick | | 296/168 |
| 3,801,135 | 4/1974 | Winters | | 296/168 |
| 3,825,281 | 7/1974 | Howard | | D12/103 |
| 4,669,773 | 6/1987 | LeVee | | 296/168 |

Primary Examiner—Wallace R. Burke
Assistant Examiner—Melody Brown
Attorney, Agent, or Firm—Litman, McMahon & Brown

[57] **CLAIM**

The ornamental design for a horse trailer, as shown.

DESCRIPTION

FIG. 1 is a front left side (road side) perspective view of a horse trailer, showing my new design;
FIG. 2 is a front elevational view thereof;
FIG. 3 is a rear elevational view thereof;
FIG. 4 is a right side (curb side) elevational view thereof;
FIG. 5 is a left side (road side) view thereof;
FIG. 6 is a top plan view thereof;
FIG. 7 is a bottom view thereof; and,
FIG. 8 is an enlarged, fragmentary, vertical, cross-sectional view thereof, taken generally along line 8—8 in FIG. 5, and particularly showing an extruded rail thereof.

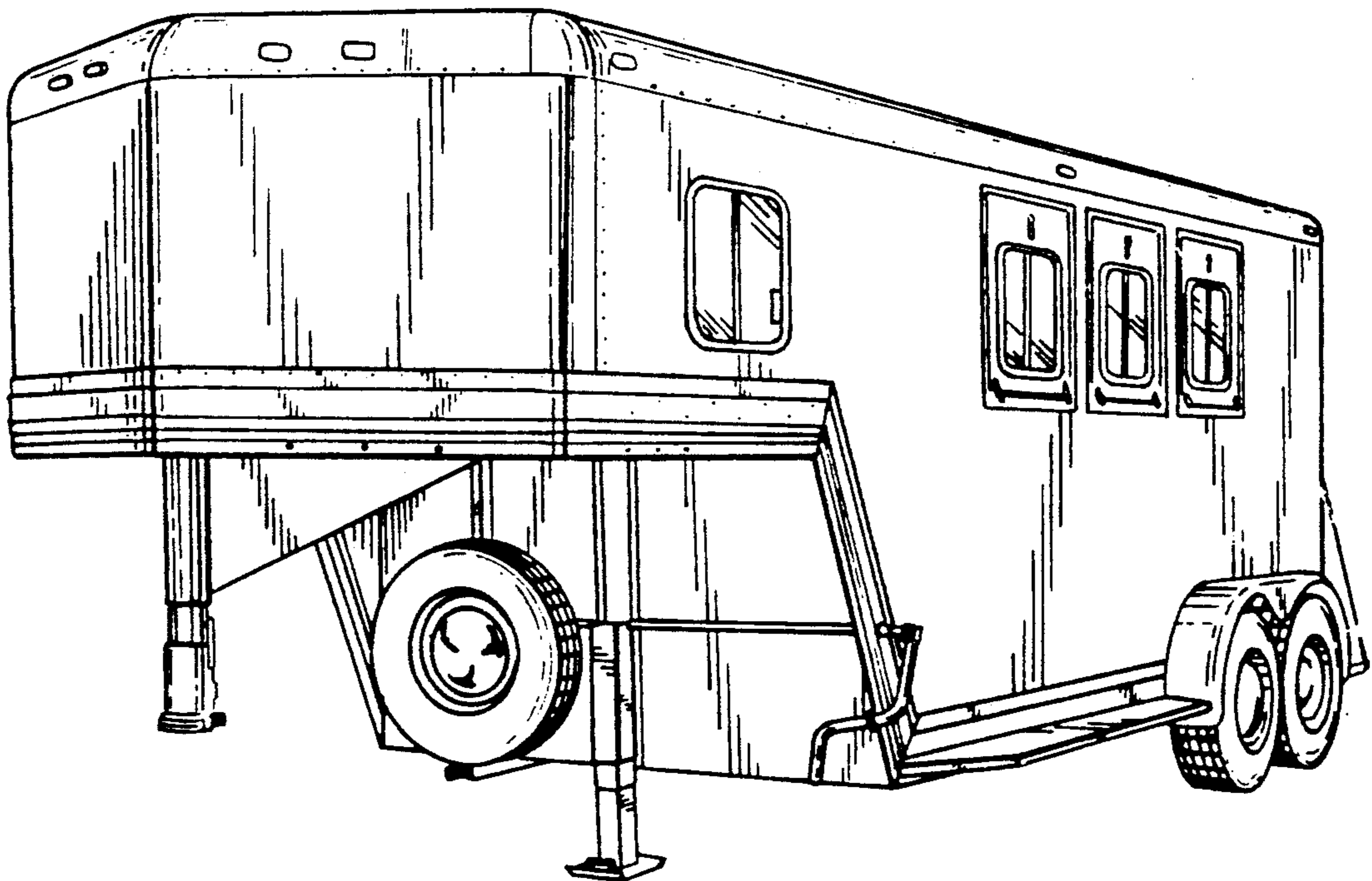

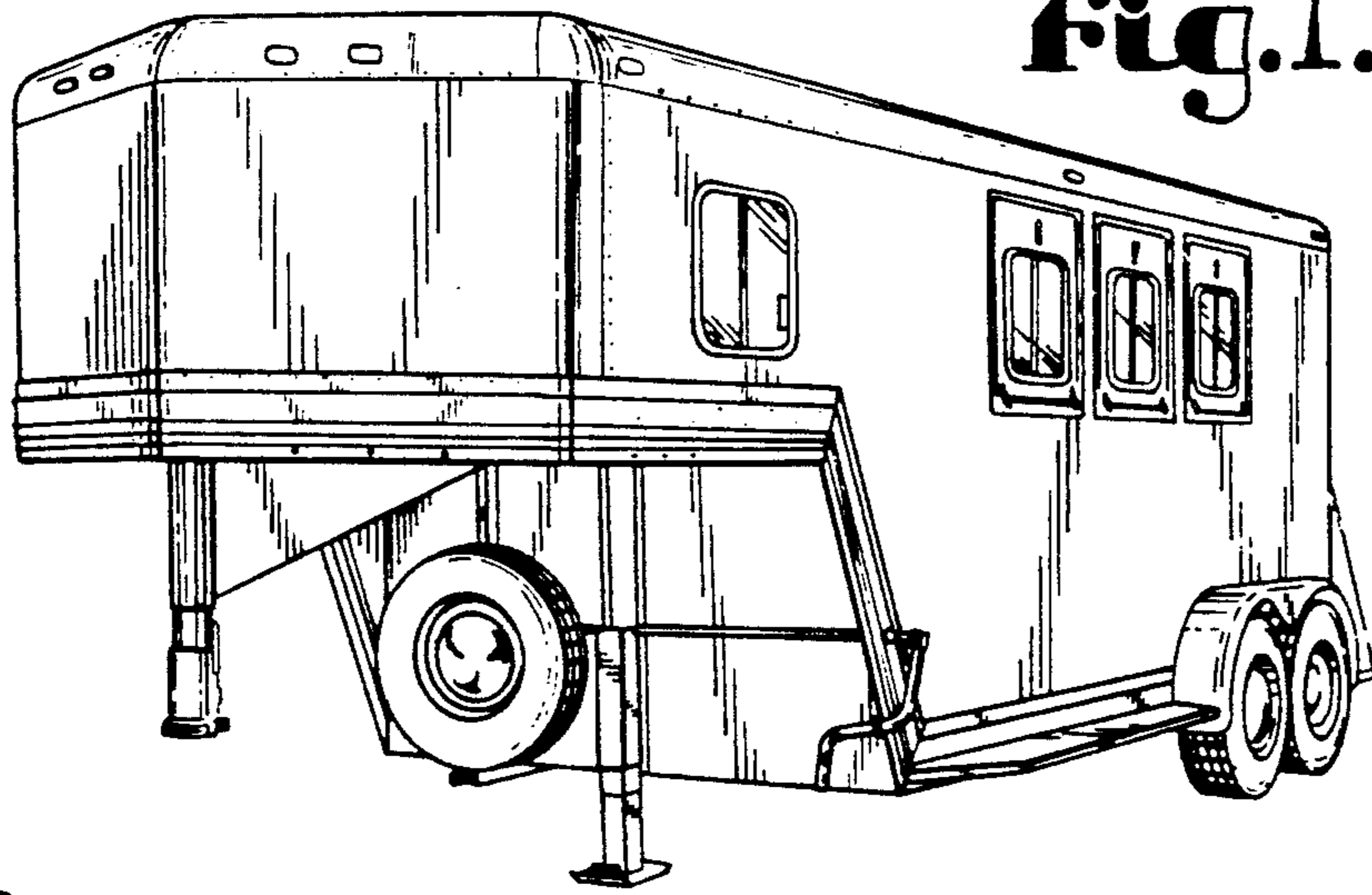

Fig. 1.

Fig. 2.

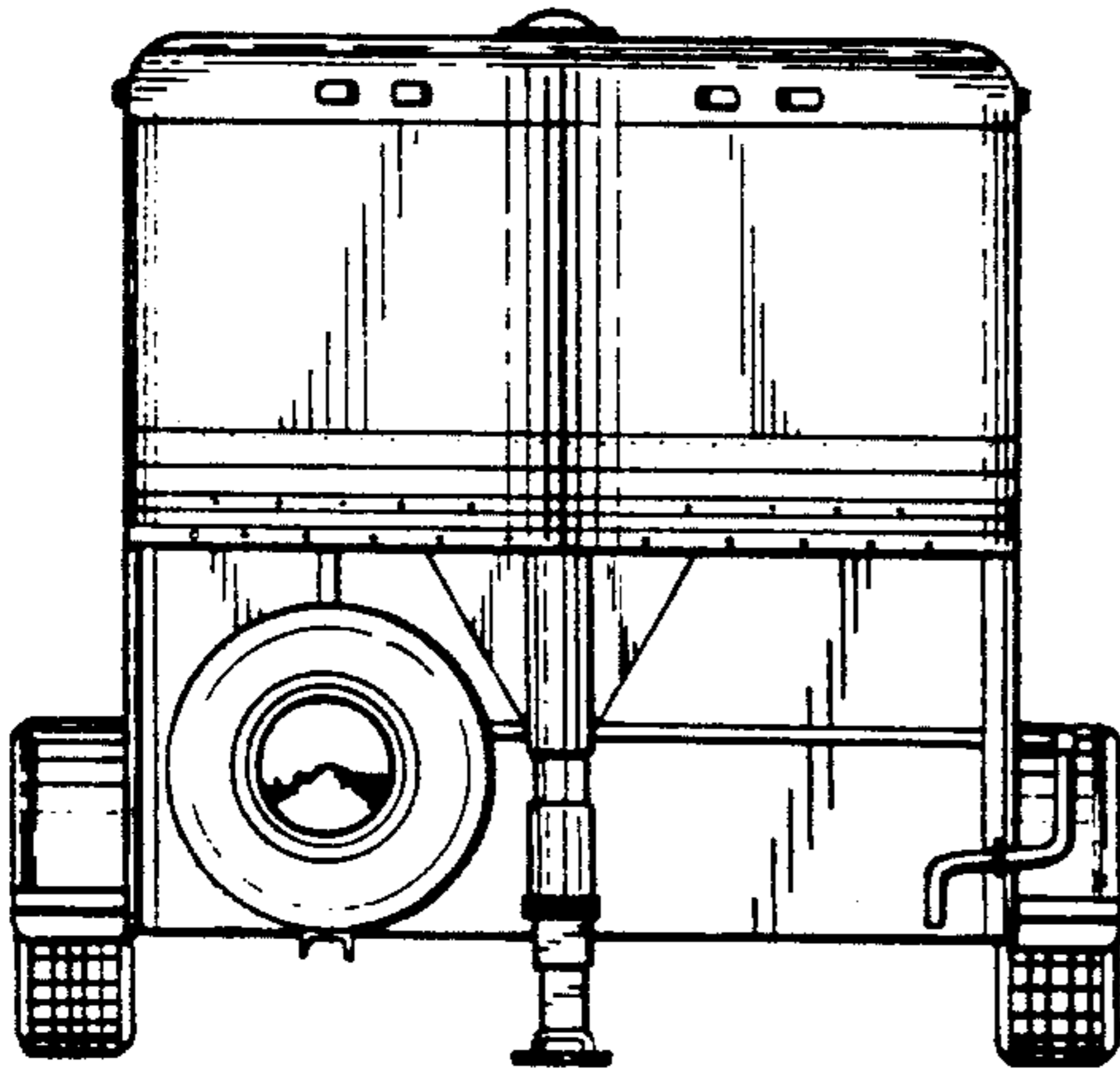

Fig. 3.

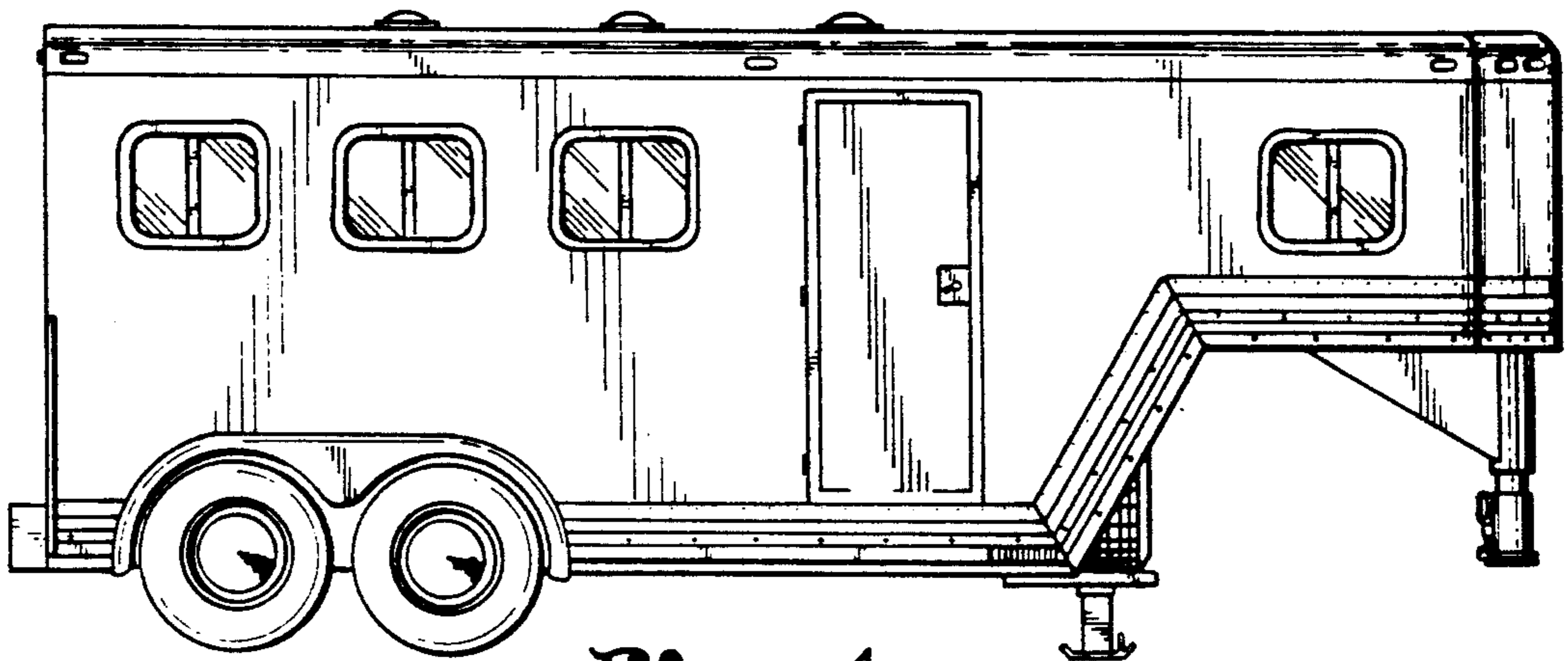
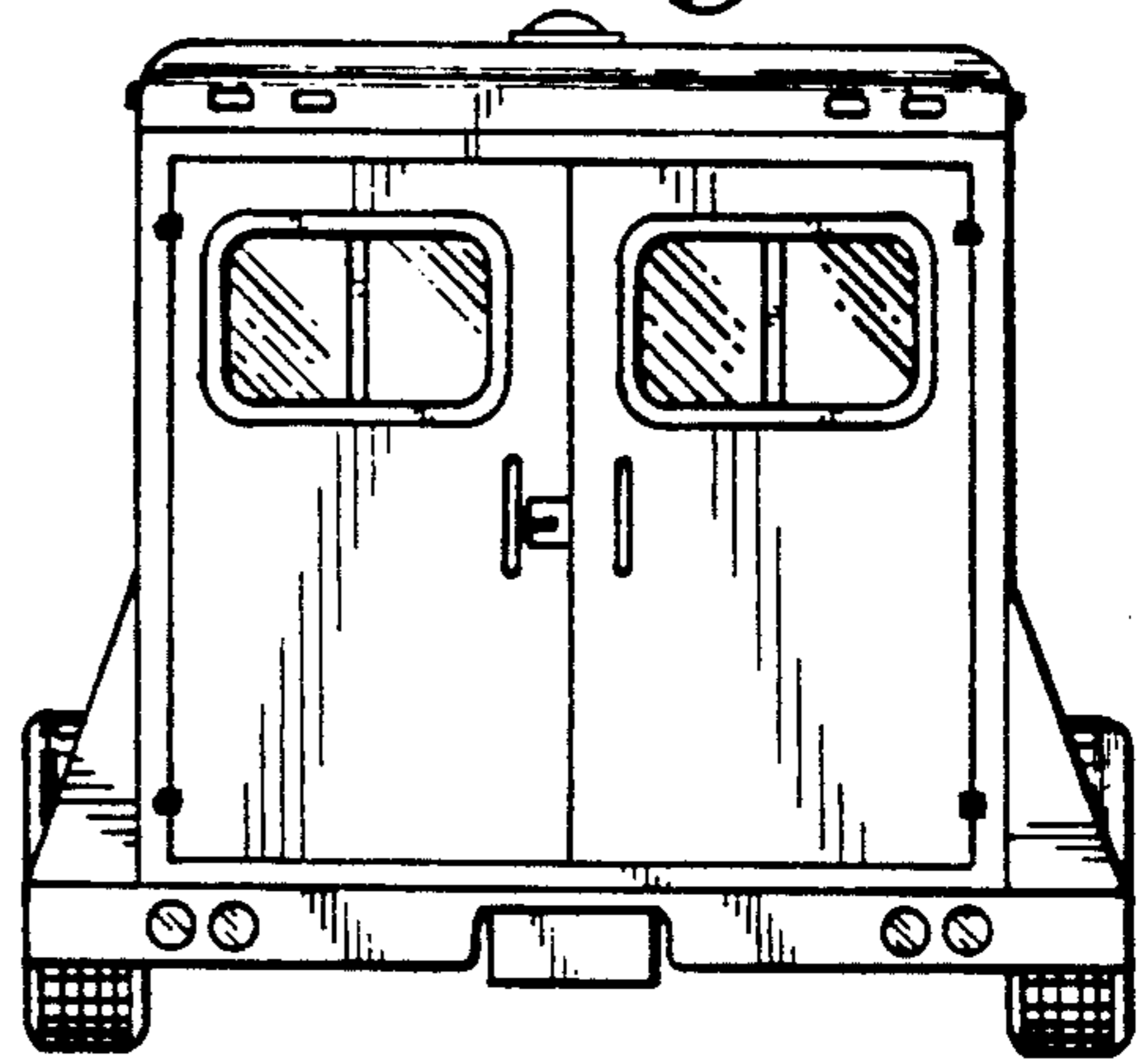

Fig. 4.

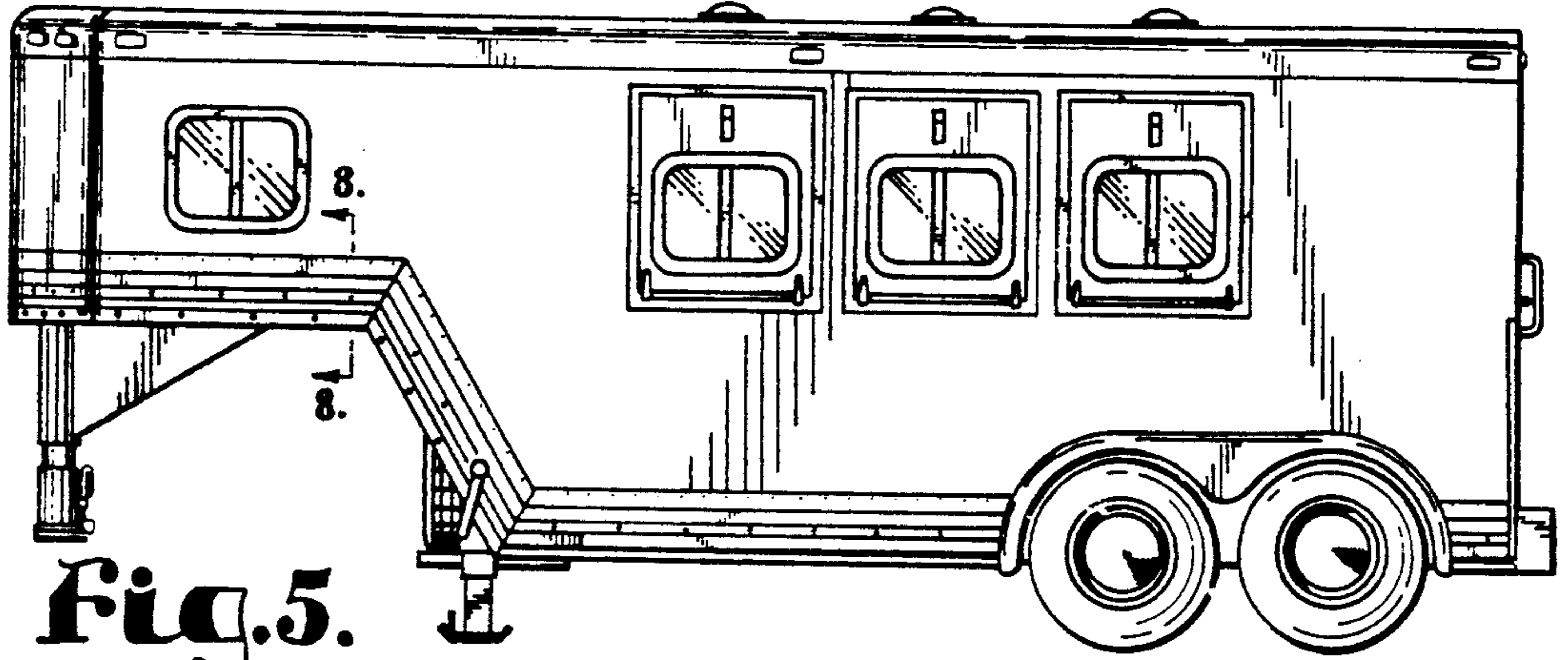

Fig. 5.

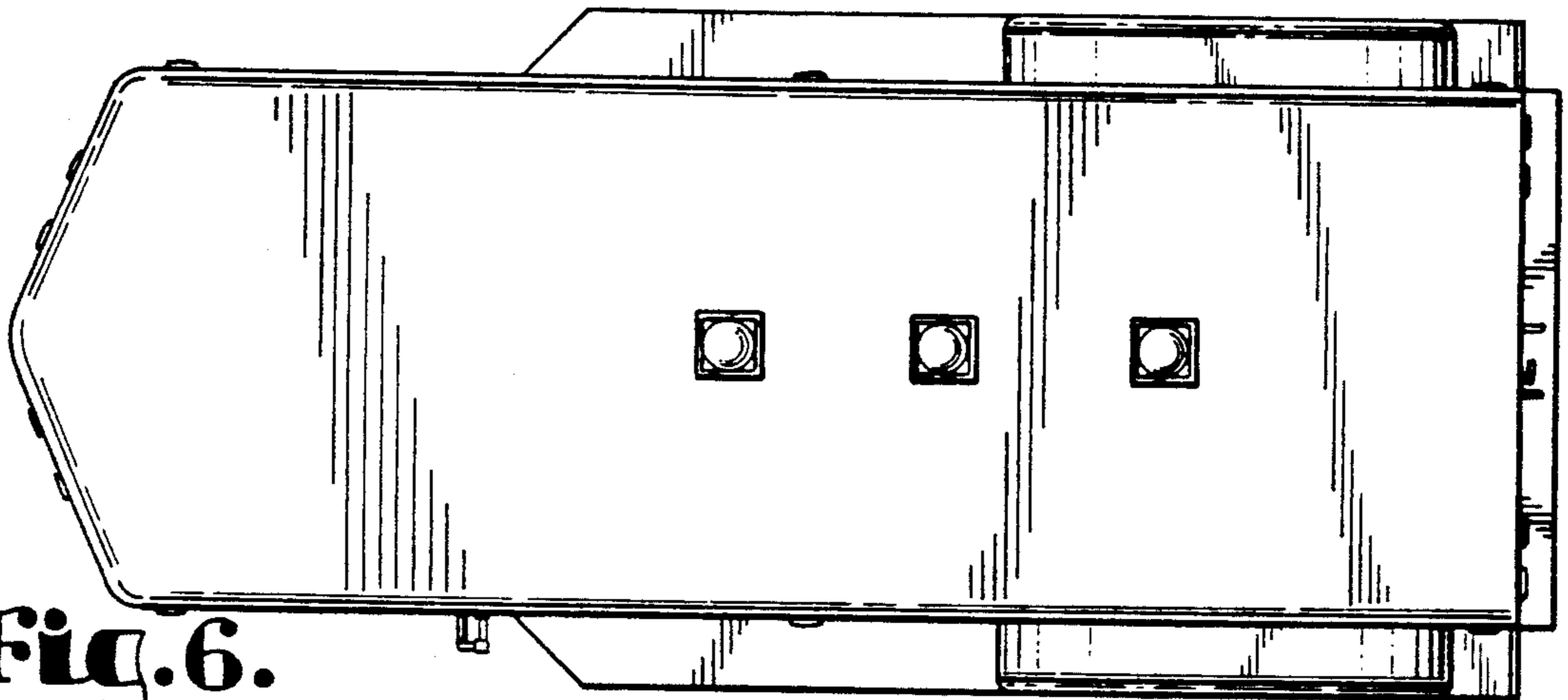

Fig. 6.

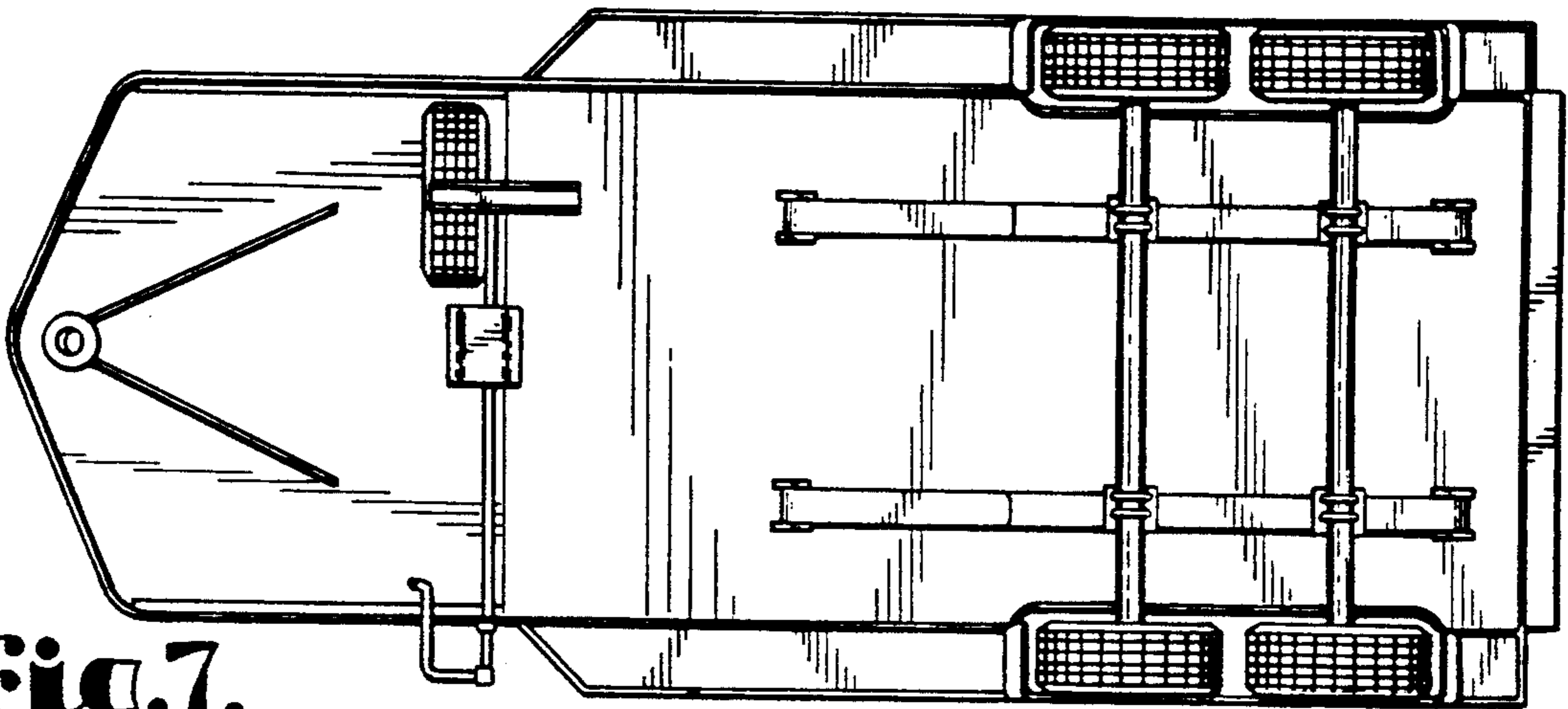

Fig. 7.

Fig. 8.

