



US00D342656S

United States Patent [19]

[11] Patent Number: Des. 342,656

Hochfeld et al.

[45] Date of Patent: ** Dec. 28, 1993

[54] STAPLE REMOVER

[75] Inventors: Stanley Hochfeld, 80-16 151st Ave., Howard Beach, N.Y. 11414; Robert Perlmutter, Queens, N.Y.

[73] Assignee: Stanley Hochfeld, Howard Beach, N.Y.

[**] Term: 14 Years

[21] Appl. No.: 695,237

[22] Filed: May 3, 1991

[52] U.S. Cl. D8/48; D8/14

[58] Field of Search D8/48, 14; 254/28

[56] References Cited

U.S. PATENT DOCUMENTS

864,223	8/1907	Behr .	
910,173	1/1909	Cochran	254/28
985,135	2/1911	Bigelow	254/28
2,212,080	8/1940	Seward .	
2,518,485	8/1950	Maynard	254/28
2,563,227	8/1951	Emery .	
3,583,673	6/1971	Poskin .	
3,625,482	12/1971	Viel, III .	
3,698,689	10/1972	Poskin .	
3,825,226	7/1974	Appleman .	
4,049,236	9/1977	Grill .	
4,553,737	11/1985	Yi .	
5,031,881	7/1991	Thurmston	254/28
5,090,663	2/1992	Crutchfield	254/28

FOREIGN PATENT DOCUMENTS

341263	10/1920	Fed. Rep. of Germany .	
2172835	10/1986	United Kingdom	254/28
2223978	4/1990	United Kingdom .	

Primary Examiner—Bernard Ansher

Assistant Examiner—R. Barkai

Attorney, Agent, or Firm—Frishauf, Holtz, Goodman & Woodward

[57] CLAIM

The ornamental design for a staple remover, as shown and described.

DESCRIPTION

FIG. 1 is a side, top perspective view of a staple remover showing our new design, combined with a writing implement;

FIG. 2 is a top view thereof;

FIG. 3 is a right side view thereof, the left side view being a mirror image thereof;

FIG. 4 is a bottom plan view thereof;

FIG. 5 is a front view thereof;

FIG. 6 is a rear view thereof with the writing implement in place;

FIG. 7 is a rear view thereof with the writing implement removed;

FIG. 8 is a side view of the writing implement inserted in the staple remover of FIGS. 1-6, the opposite side view, the top plan view and the bottom view being identical;

FIG. 9 is a front view thereof;

FIG. 10 is a rear view thereof;

FIG. 11 is a side, top perspective view of a staple remover without the writing implement inserted therein;

FIG. 12 is a top view thereof;

FIG. 13 is a right side view thereof, the left side view being a mirror image thereof;

FIG. 14 is a bottom plan view thereof;

FIG. 15 is a front end view thereof; and,

FIG. 16 is a rear end view thereof.

The writing implement and staple remover are shown separately in FIGS. 7-16 for ease of illustration only.

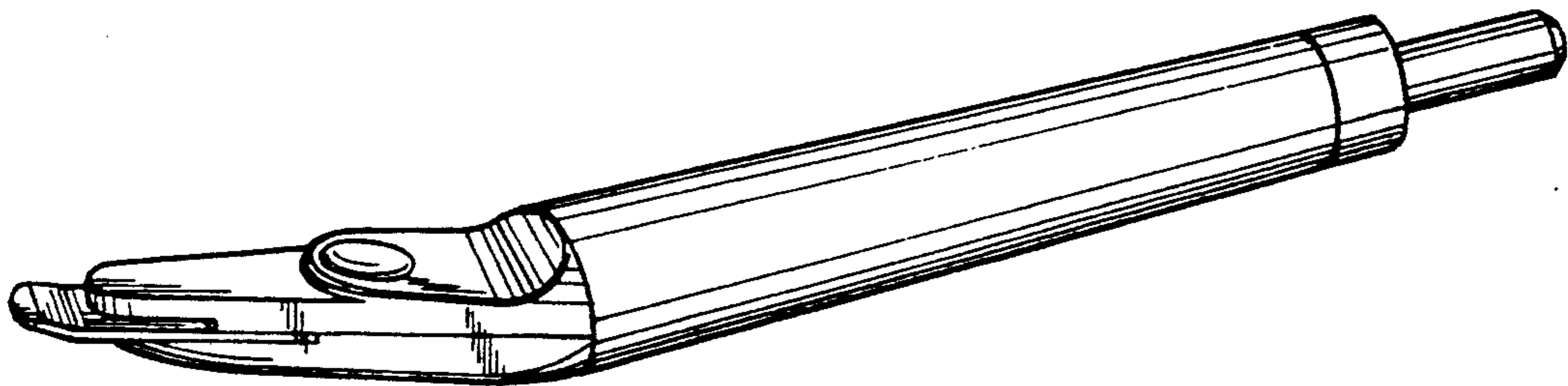

Fig. 1

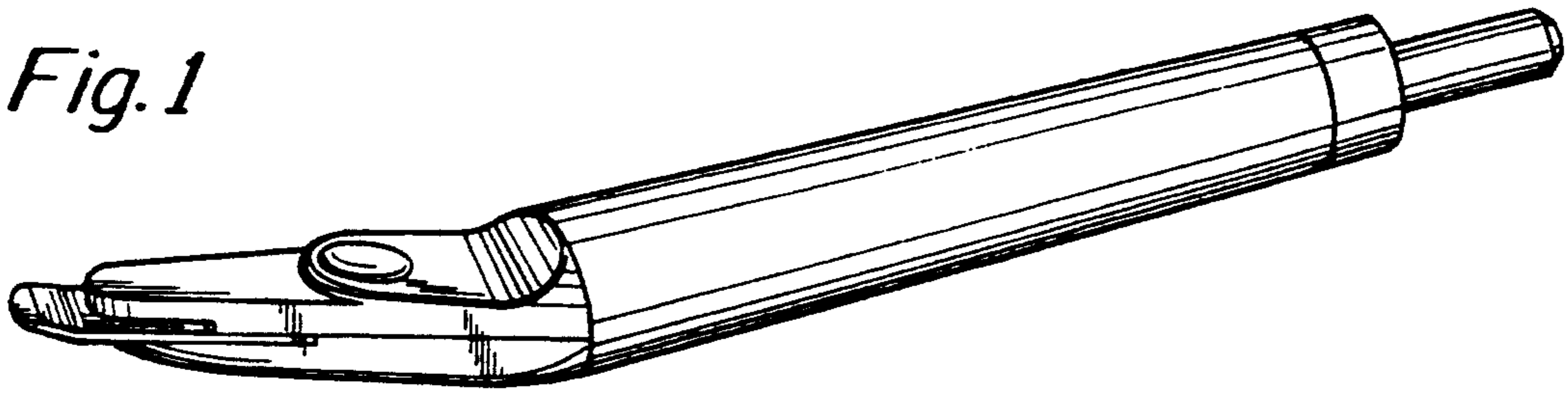

Fig. 2

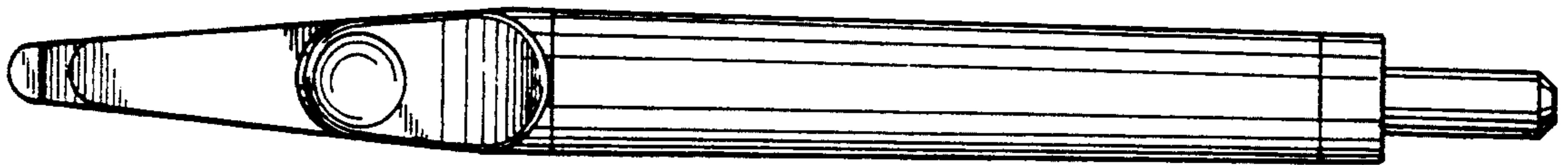

Fig. 3

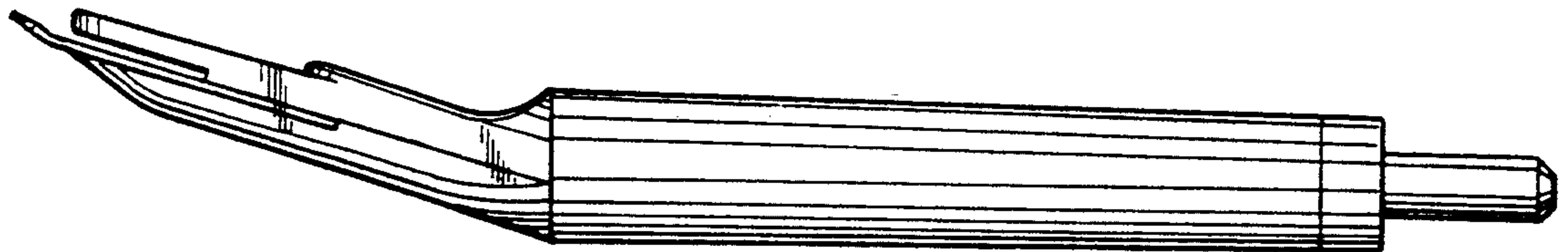

Fig. 4

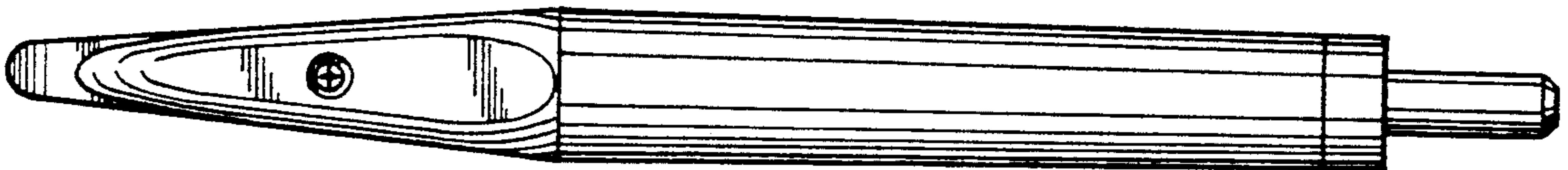

Fig. 5

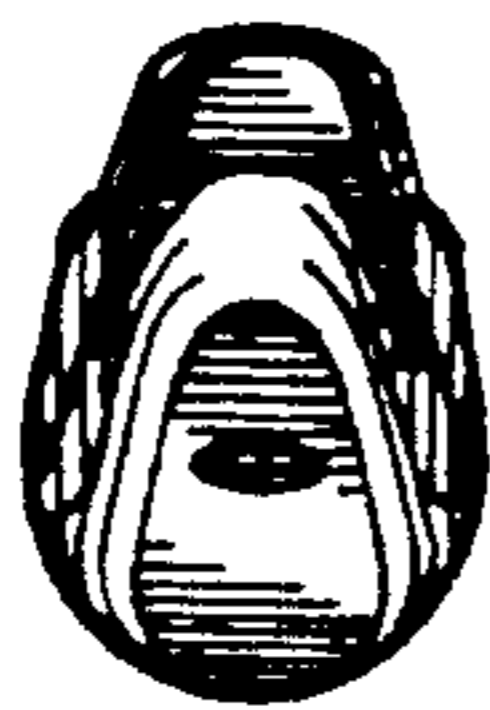

Fig. 6

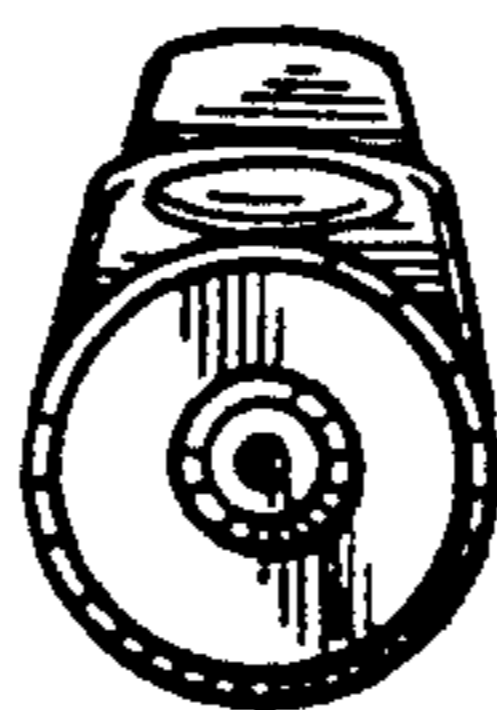

Fig. 7

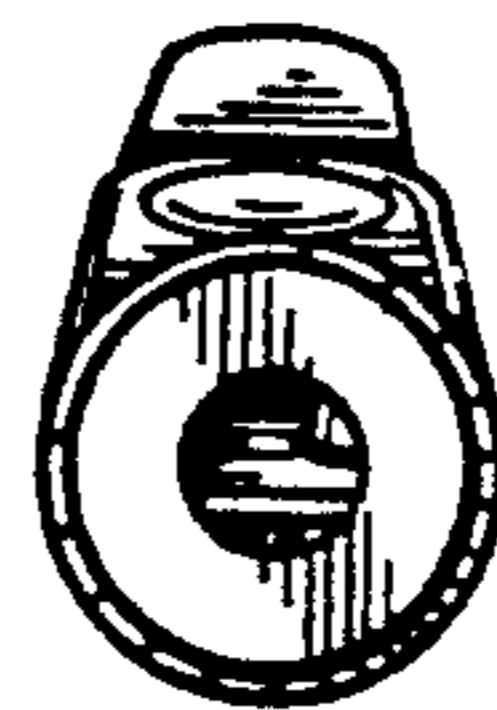

Fig. 8

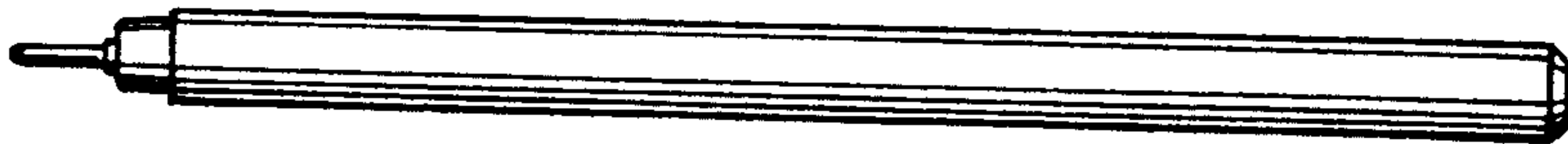

Fig. 9



Fig. 10



Fig. 11

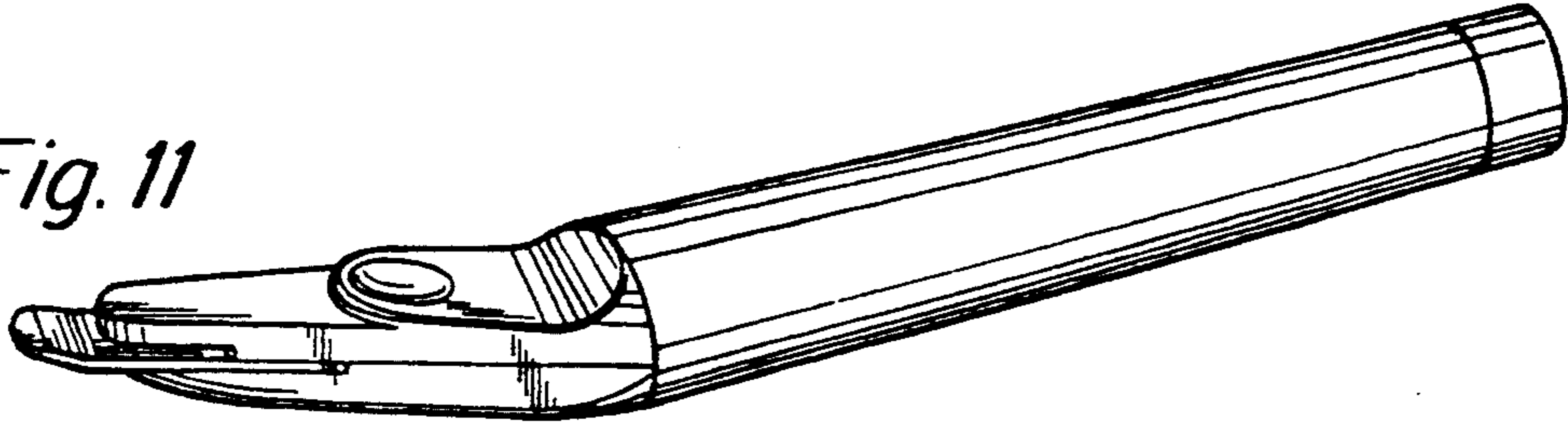

Fig. 12

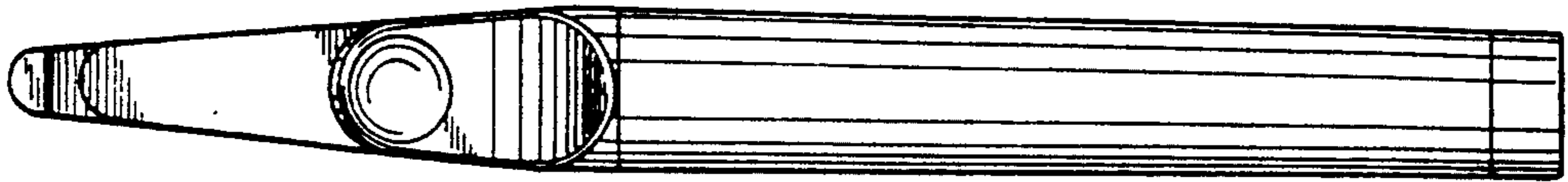

Fig. 13

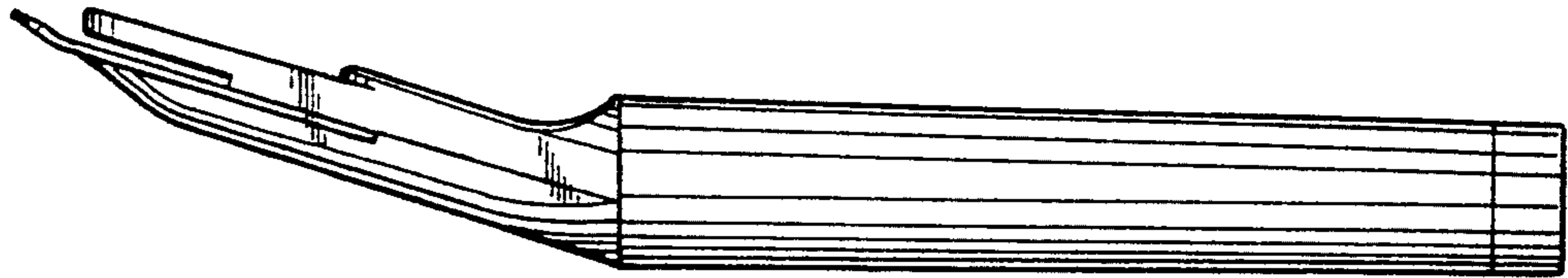

Fig. 14

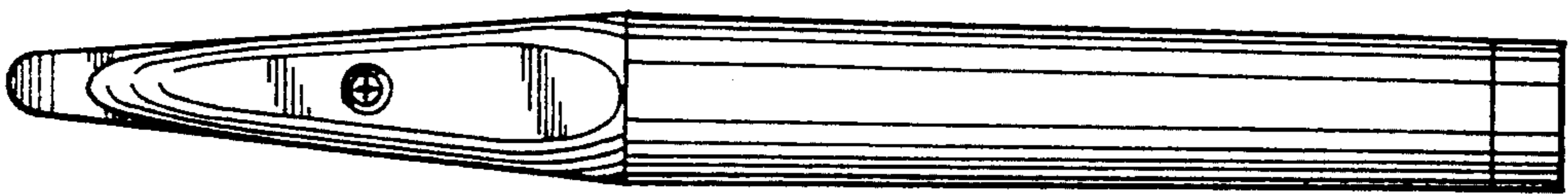

Fig. 15

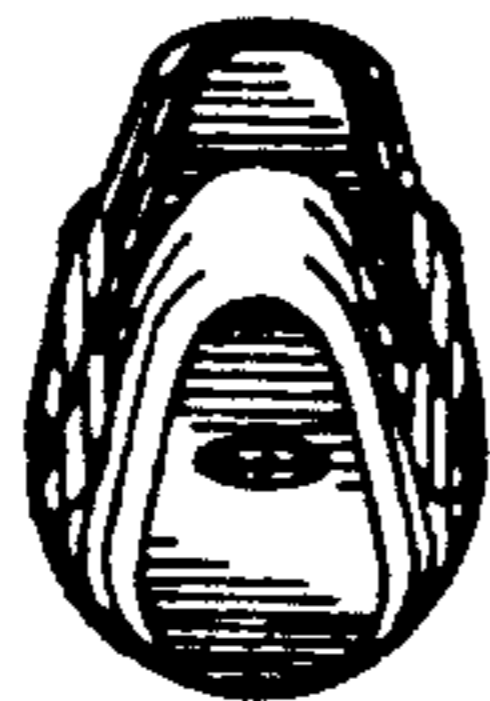

Fig. 16

