



US00D342655S

United States Patent [19]

[11] Patent Number: Des. 342,655

Ozeki

[45] Date of Patent: ** Dec. 28, 1993

[54] HOLDER FOR COMPACT DISCS

[75] Inventor: Jiro Ozeki, Tokyo, Japan

[73] Assignee: Slidex Corporation, Tokyo, Japan

[**] Term: 14 Years

[21] Appl. No.: 900,876

[22] Filed: Jun. 18, 1992

[30] Foreign Application Priority Data

Dec. 25, 1991 [JP] Japan 3-39000

[52] U.S. Cl. D3/35; D3/74

[58] Field of Search D3/30.1, 35, 74;
D6/407, 408, 457, 476; D19/26, 27, 75, 76;
206/387, 444, 424, 311; 211/40, 41, 42

[56] References Cited

U.S. PATENT DOCUMENTS

D. 229,122	11/1973	Price	D3/35
D. 238,111	12/1975	Shyers	D3/35
D. 294,774	3/1988	Kitada	D3/35
D. 315,982	4/1991	Kunimune et al.	D3/35
D. 321,783	11/1991	Ozeki	D3/35
4,760,914	8/1988	Yelardi et al.	206/387
4,805,769	2/1989	Soltis et al.	206/387
4,892,189	1/1990	Kunimune et al.	206/311
4,919,287	4/1990	Haskett et al.	211/41
5,011,016	4/1991	Ozeki	206/444
5,072,836	12/1991	Gross	211/40

Primary Examiner—A. Hugo Word

Assistant Examiner—Celia A. Murphy

Attorney, Agent, or Firm—Keck, Mahin & Cate

[57] CLAIM

The ornamental design for a holder for compact discs, as shown and described.

DESCRIPTION

FIG. 1 is a front perspective view of a holder for compact discs showing my new design;
 FIG. 2 is a rear perspective view thereof;
 FIG. 3 is a front view thereof;
 FIG. 4 is a right side view thereof;
 FIG. 5 is a left side view thereof;
 FIG. 6 is a top plan view thereof;
 FIG. 7 is a bottom plan view thereof;
 FIG. 8 is a perspective view thereof shown in a partially open position;
 FIG. 9 is a perspective view thereof in a completely open position;
 FIG. 10 is a front view of FIG. 9;
 FIG. 11 is a right side view of the record disc holder shown in FIG. 10;
 FIG. 12 is a left side view of the record disc holder shown in FIG. 10;
 FIG. 13 is a rear view of the record disc holder shown in FIG. 10;
 FIG. 14 is a top plan view of the record disc holder shown in FIG. 10;
 FIG. 15 is a bottom view of the record disc holder shown in FIG. 10;
 FIG. 16 is an enlarged fragmentary view of a right upper corner of the holder for compact discs shown in FIG. 3;
 FIG. 17 is a cross-sectional view taken along line 17—17 of FIG. 16;
 FIG. 18 is a cross-sectional view taken along line 18—18 of FIG. 16;
 FIG. 19 is a perspective view thereof shown in use, the broken lines showing compact discs being for illustrative purposes only and forming no part of the claimed design; and,
 FIG. 20 is a rear perspective view of FIG. 19.

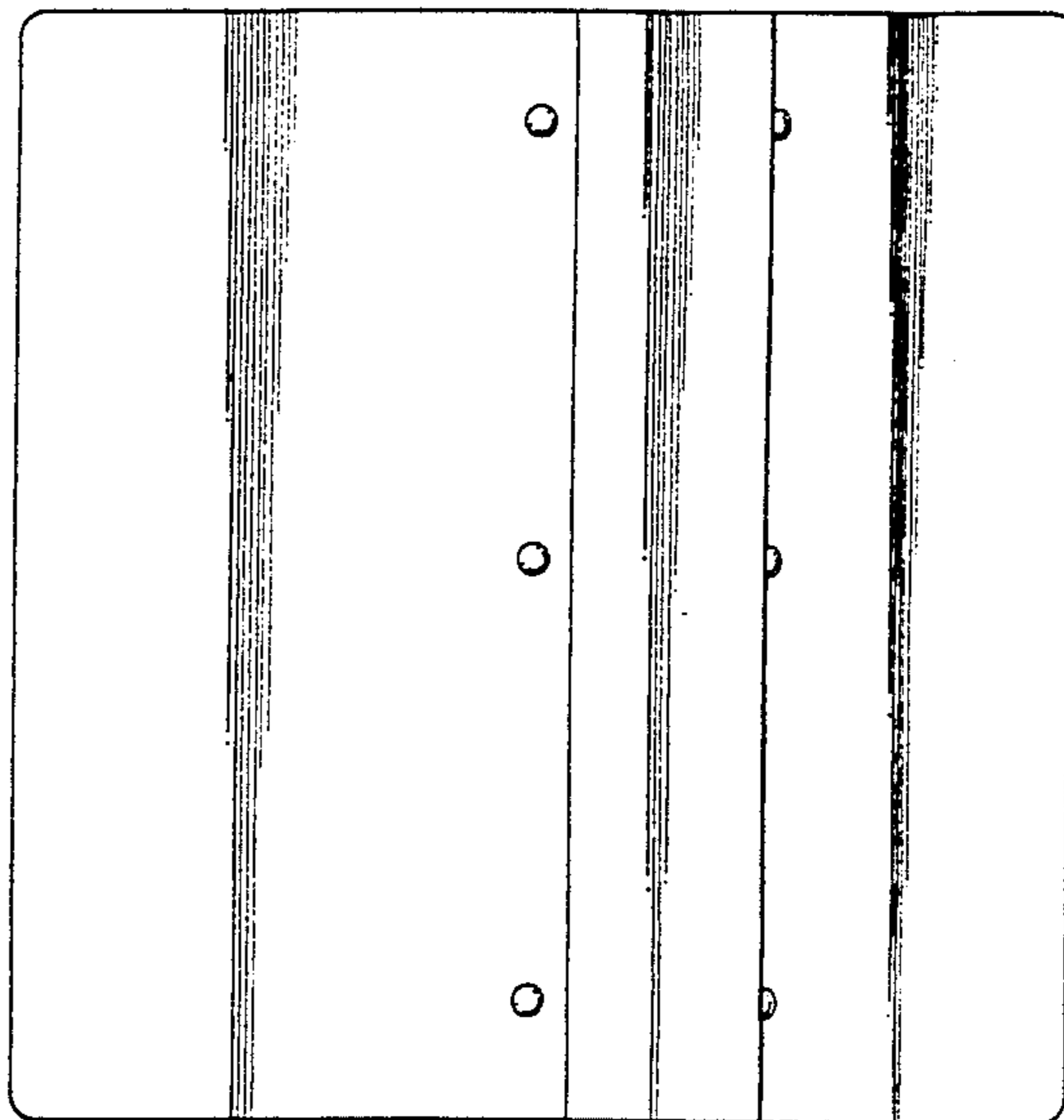
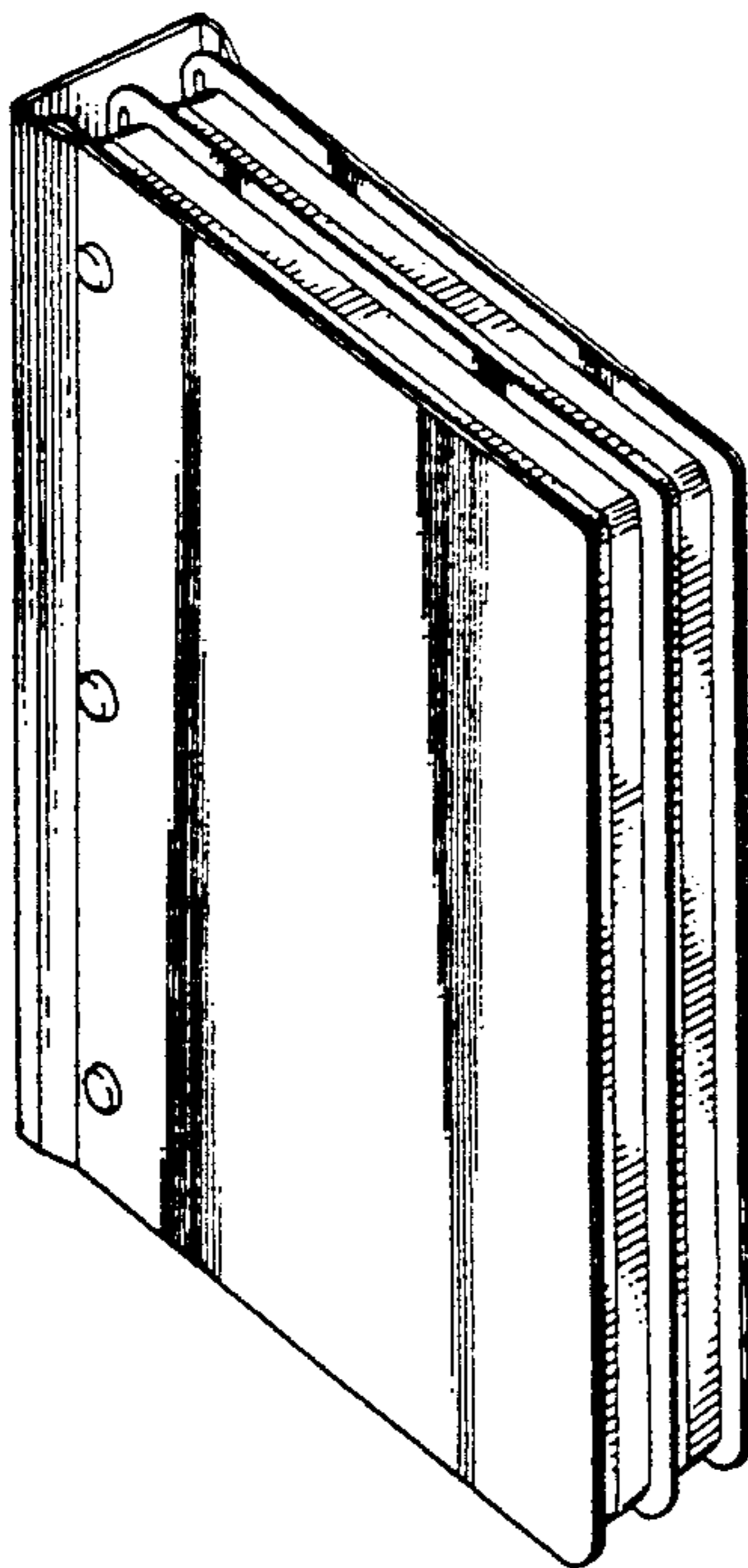

FIG. 1

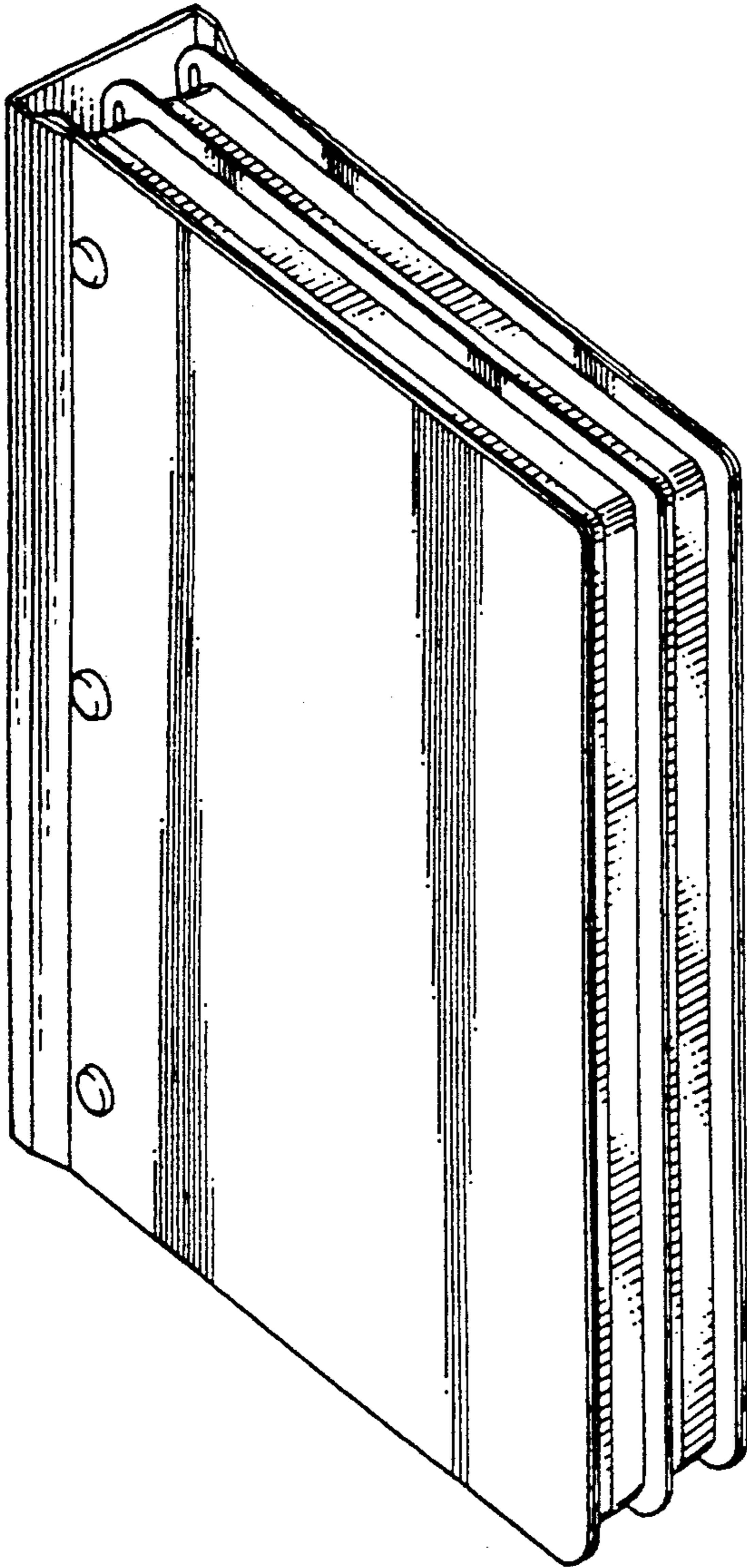

FIG. 2

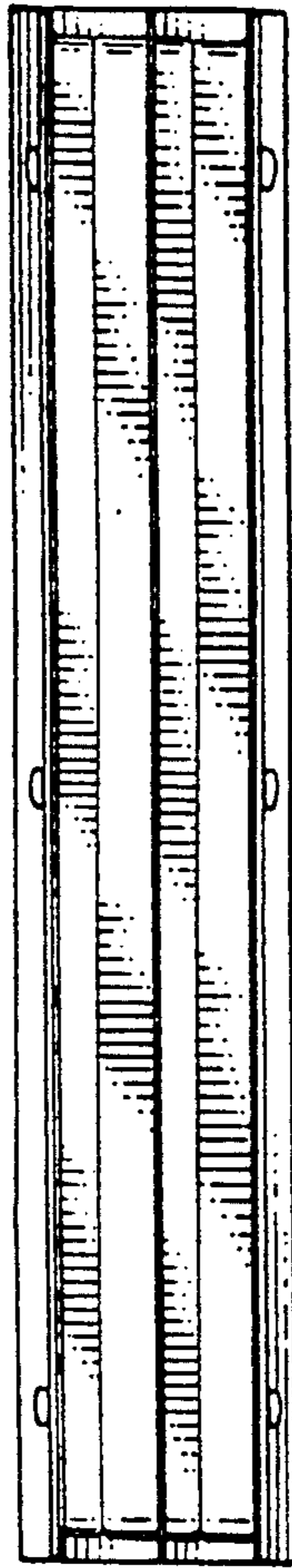

FIG. 3

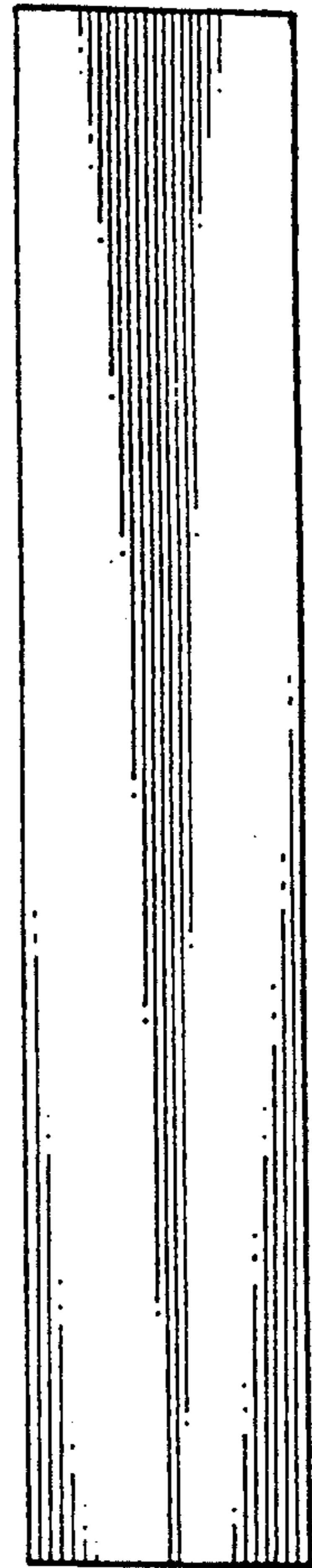

FIG. 4

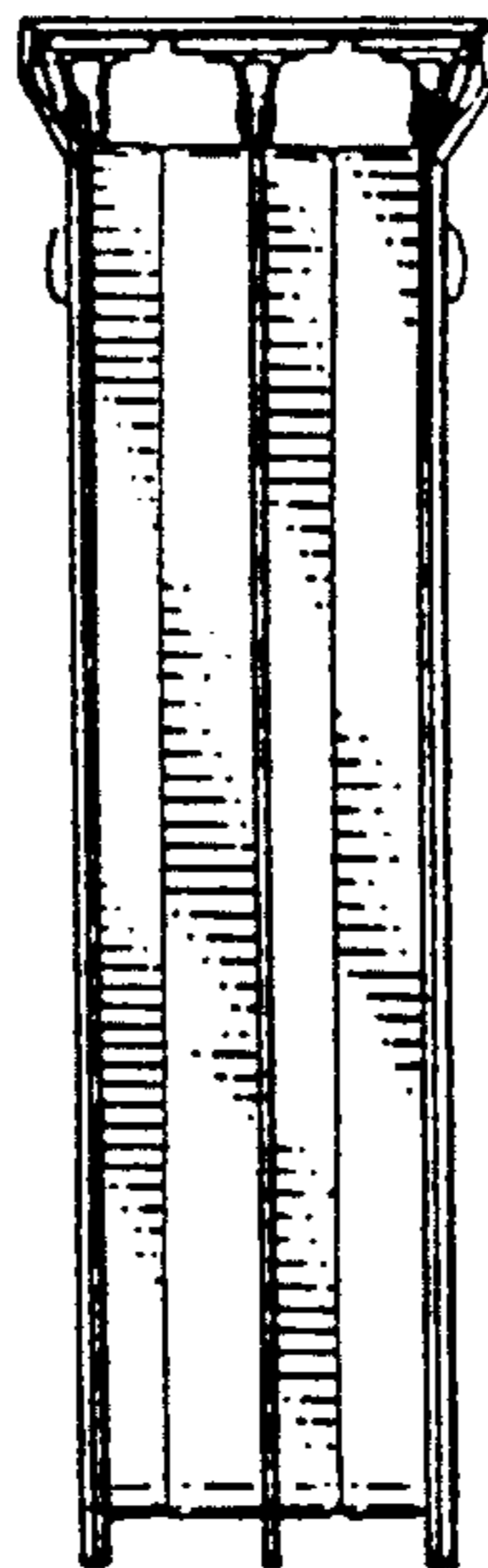

FIG. 8

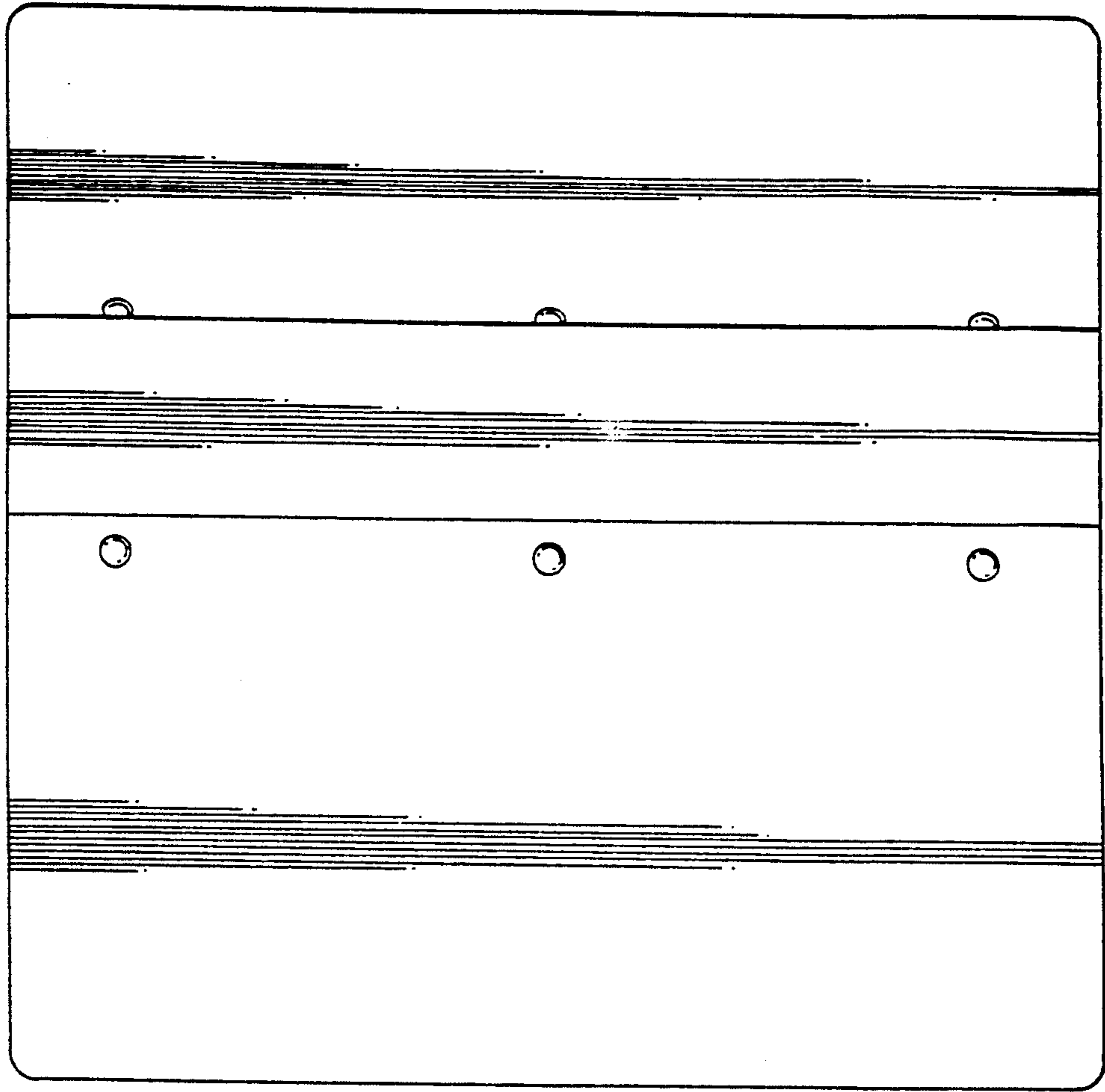

FIG. 5

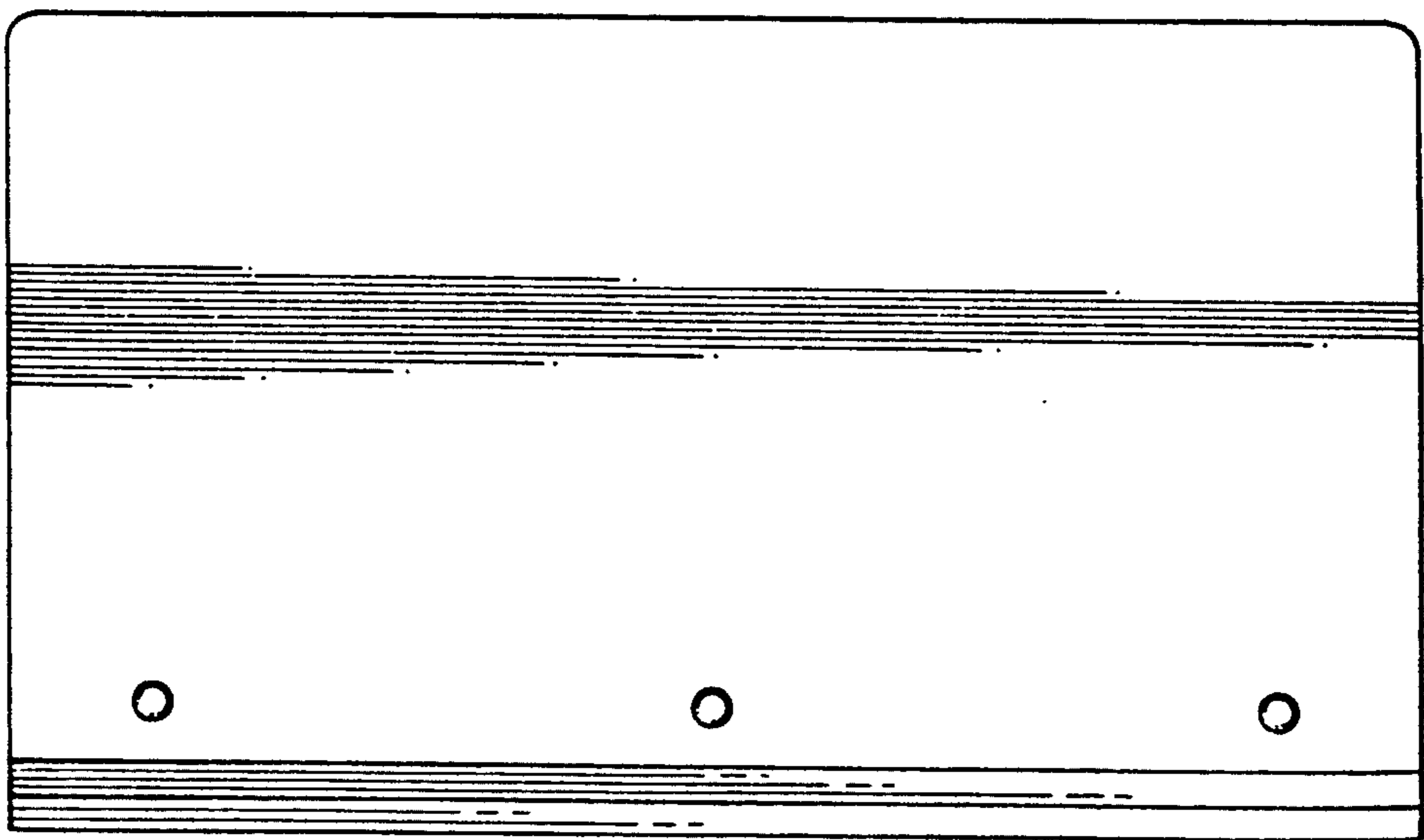

FIG. 6

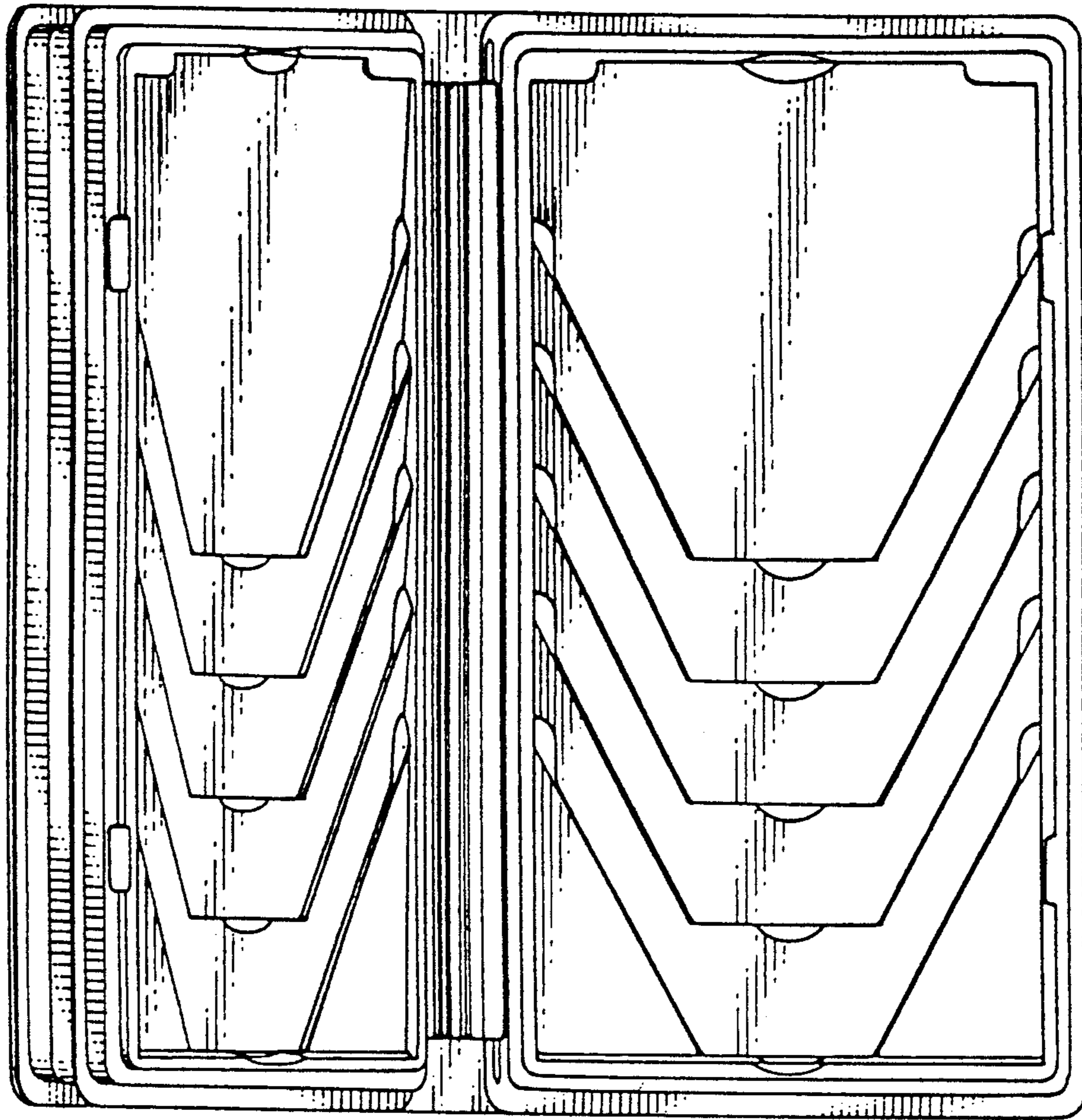

FIG. 7

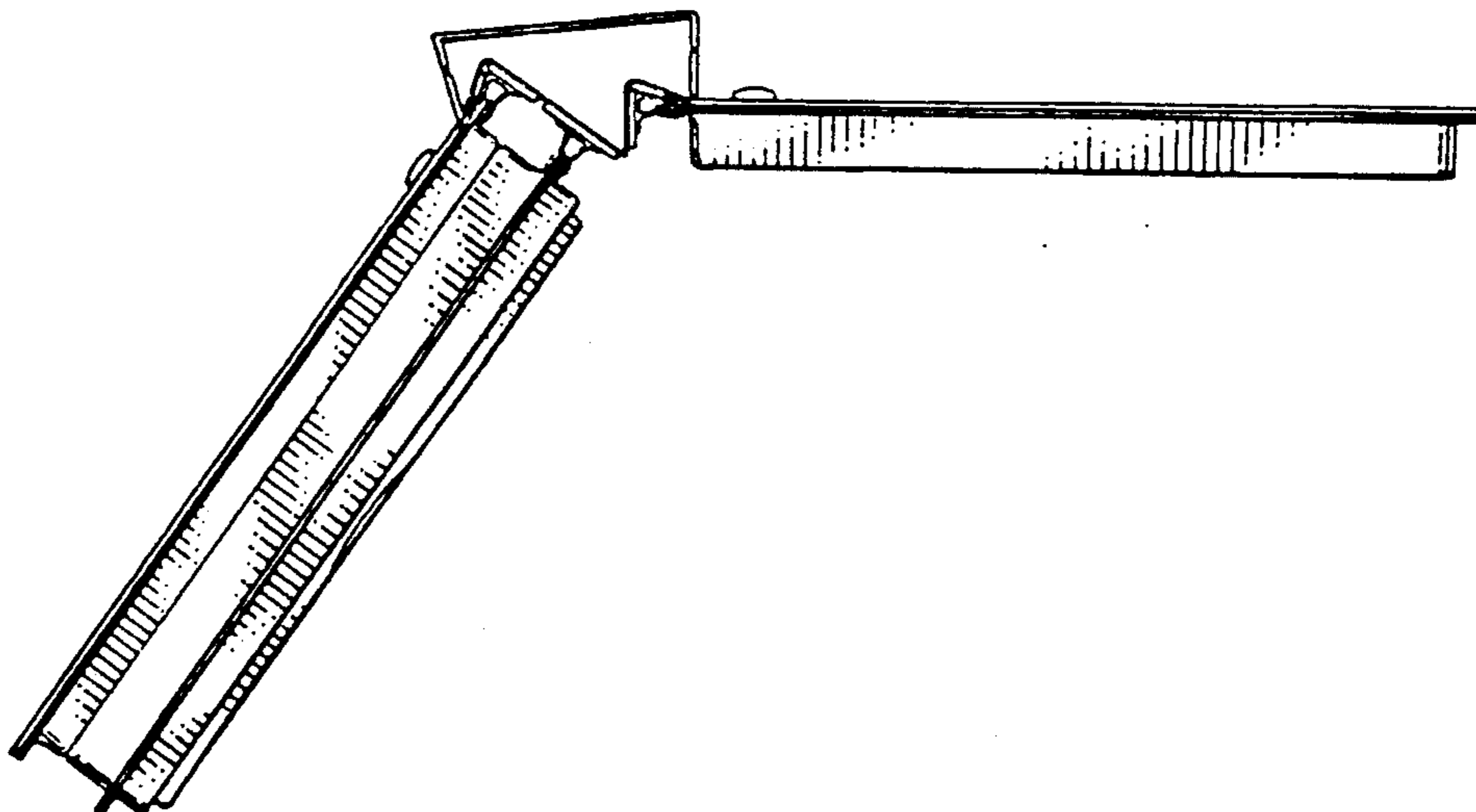

FIG. 12

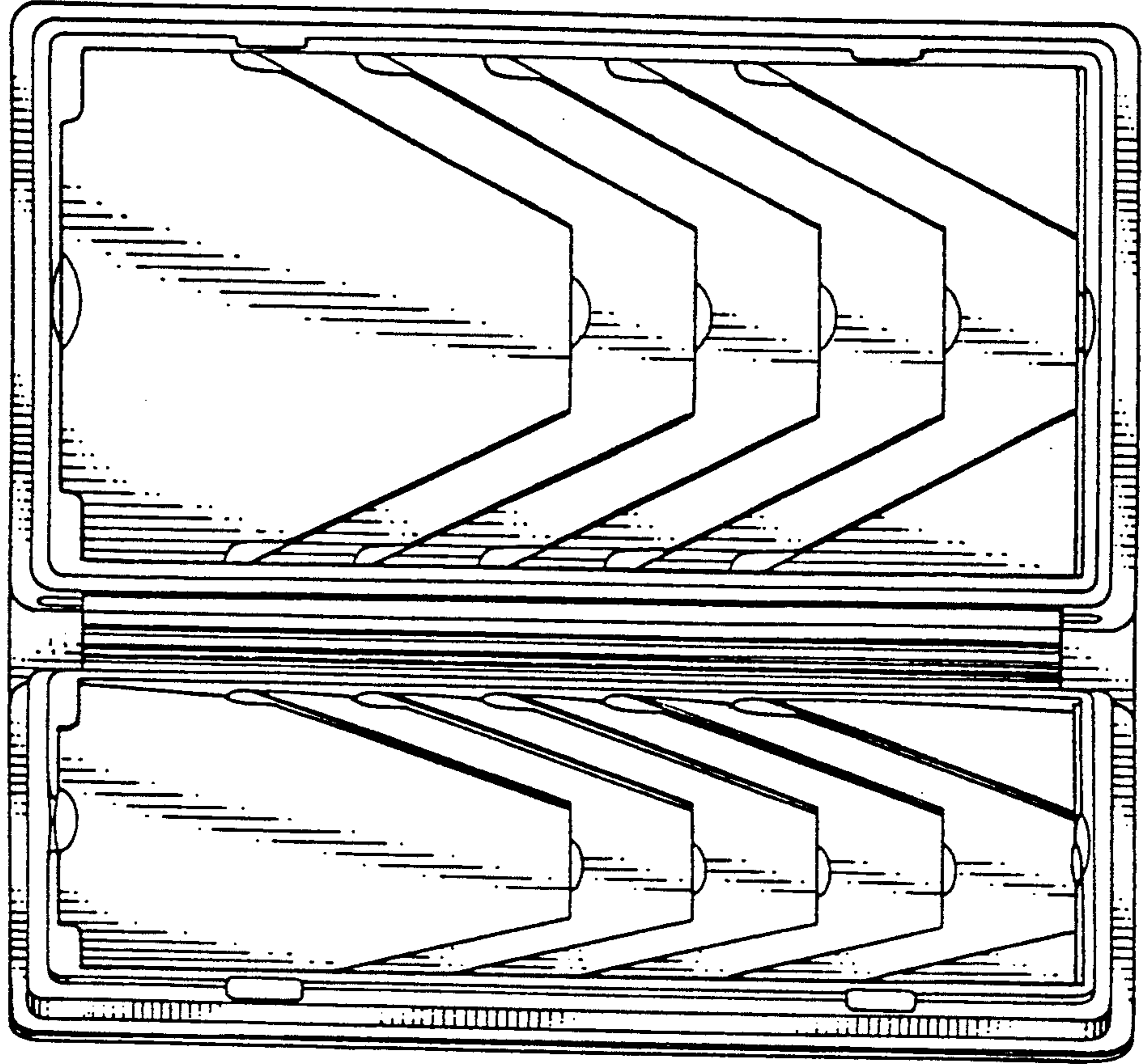

FIG. 9

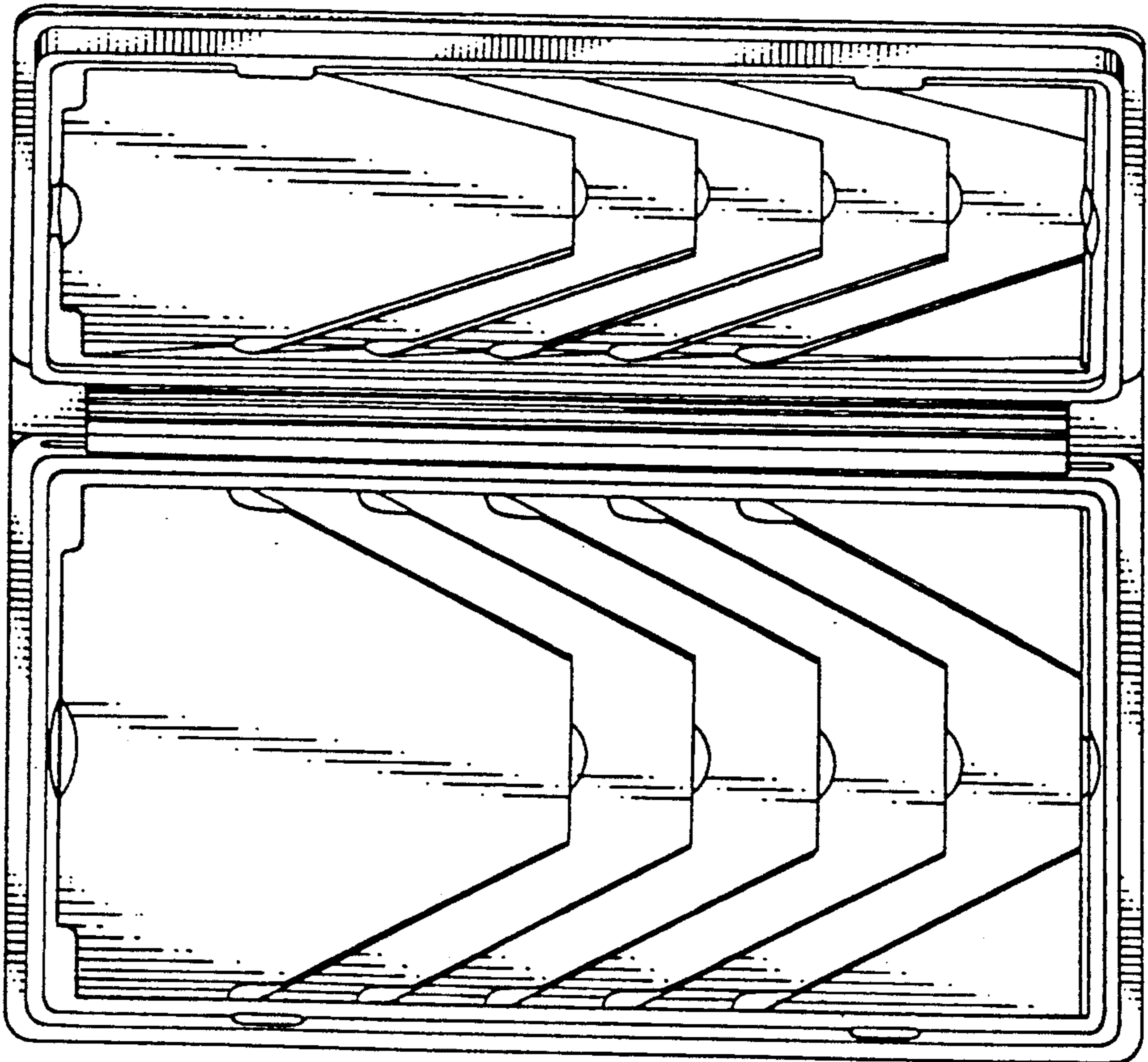

FIG. 10

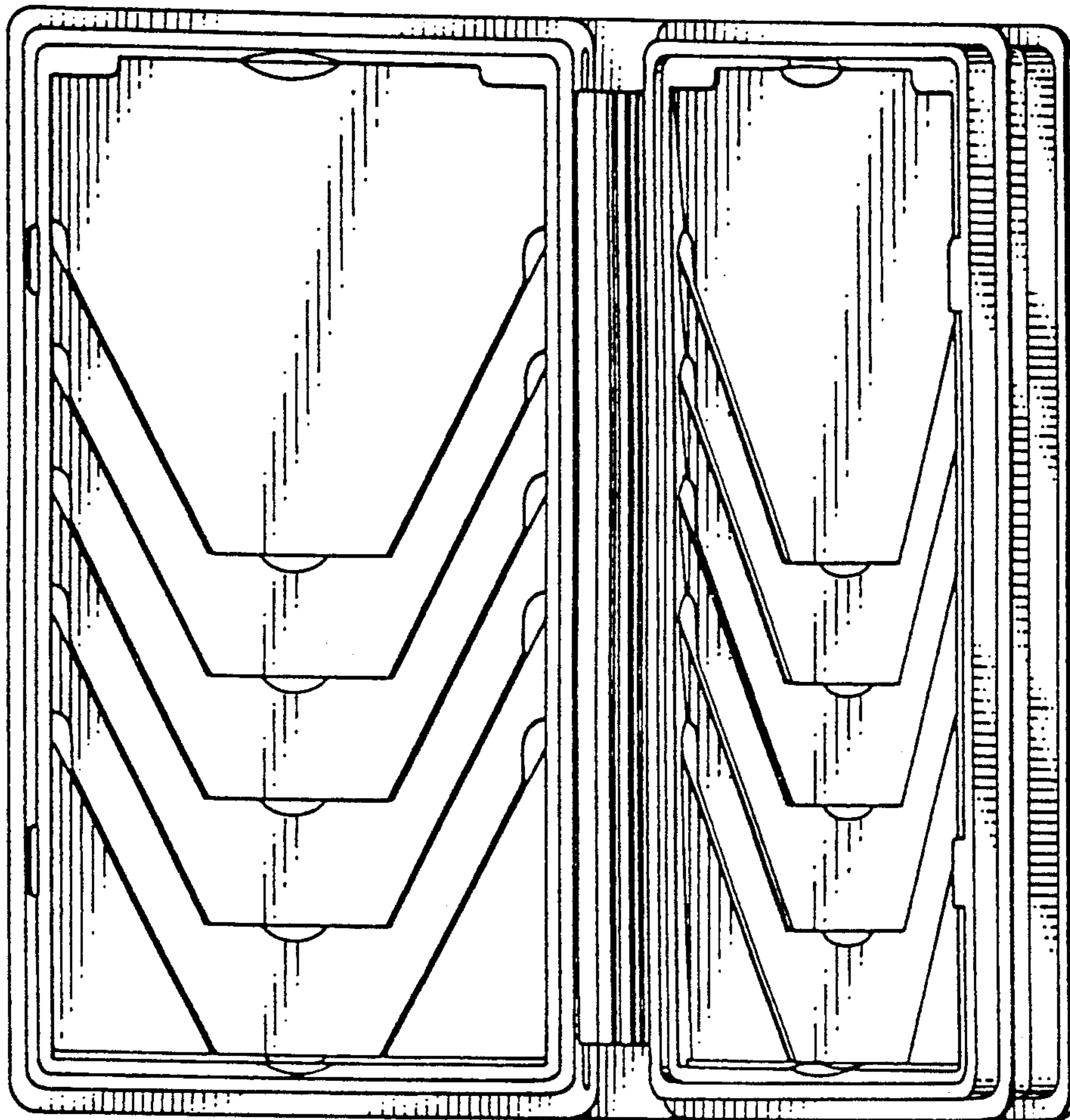

FIG. 11

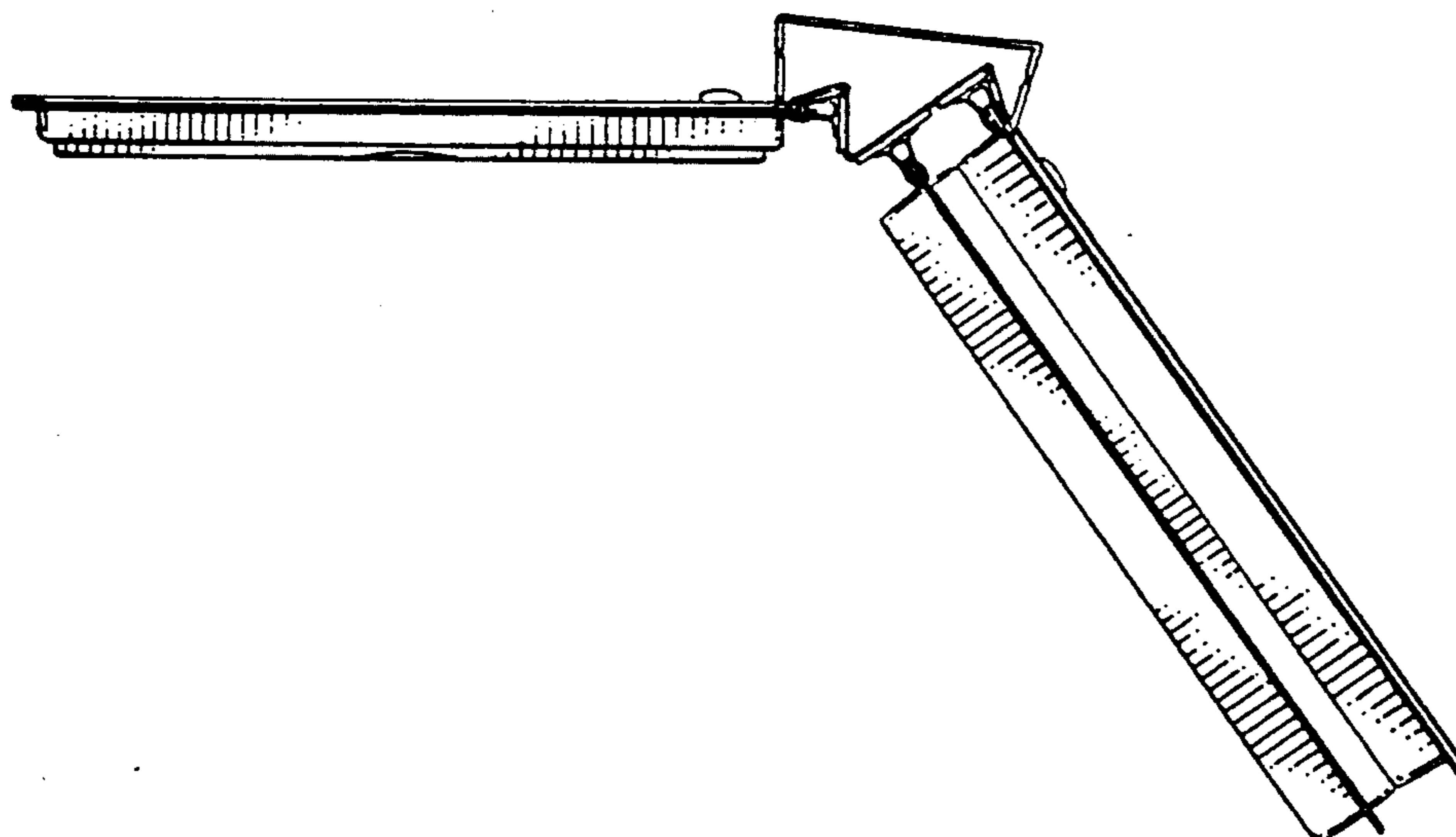

FIG. 13

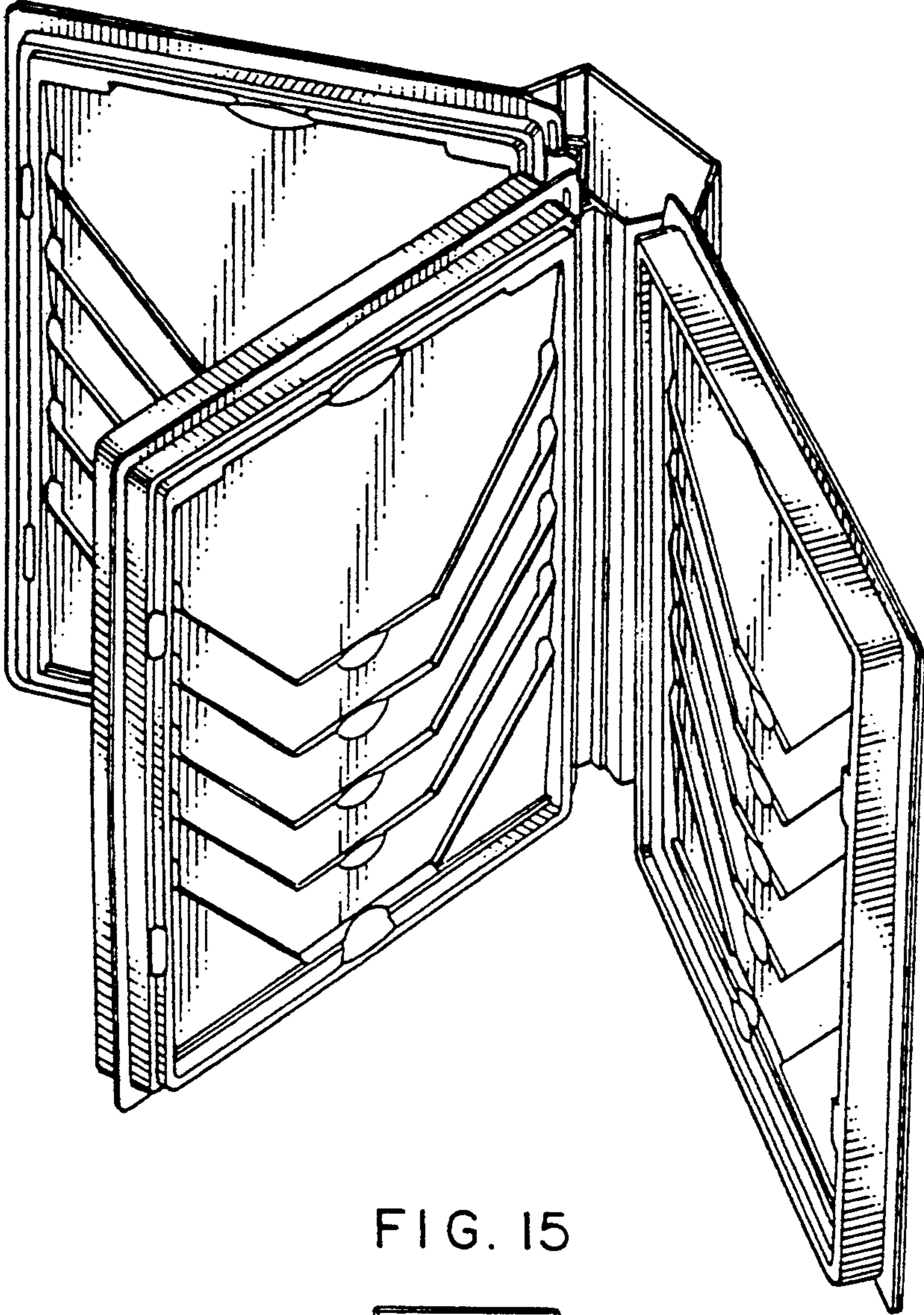

FIG. 15

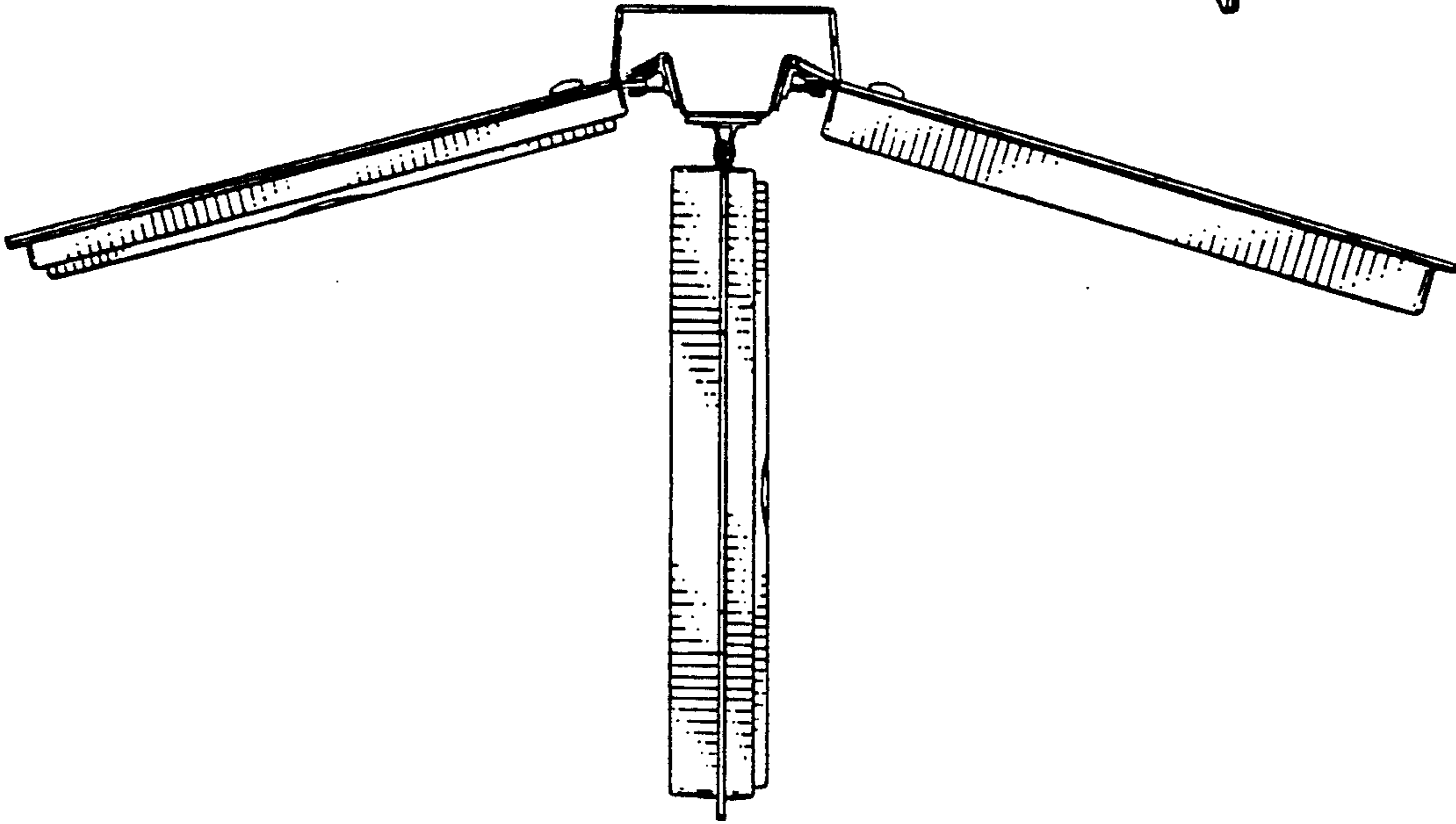

FIG. 14

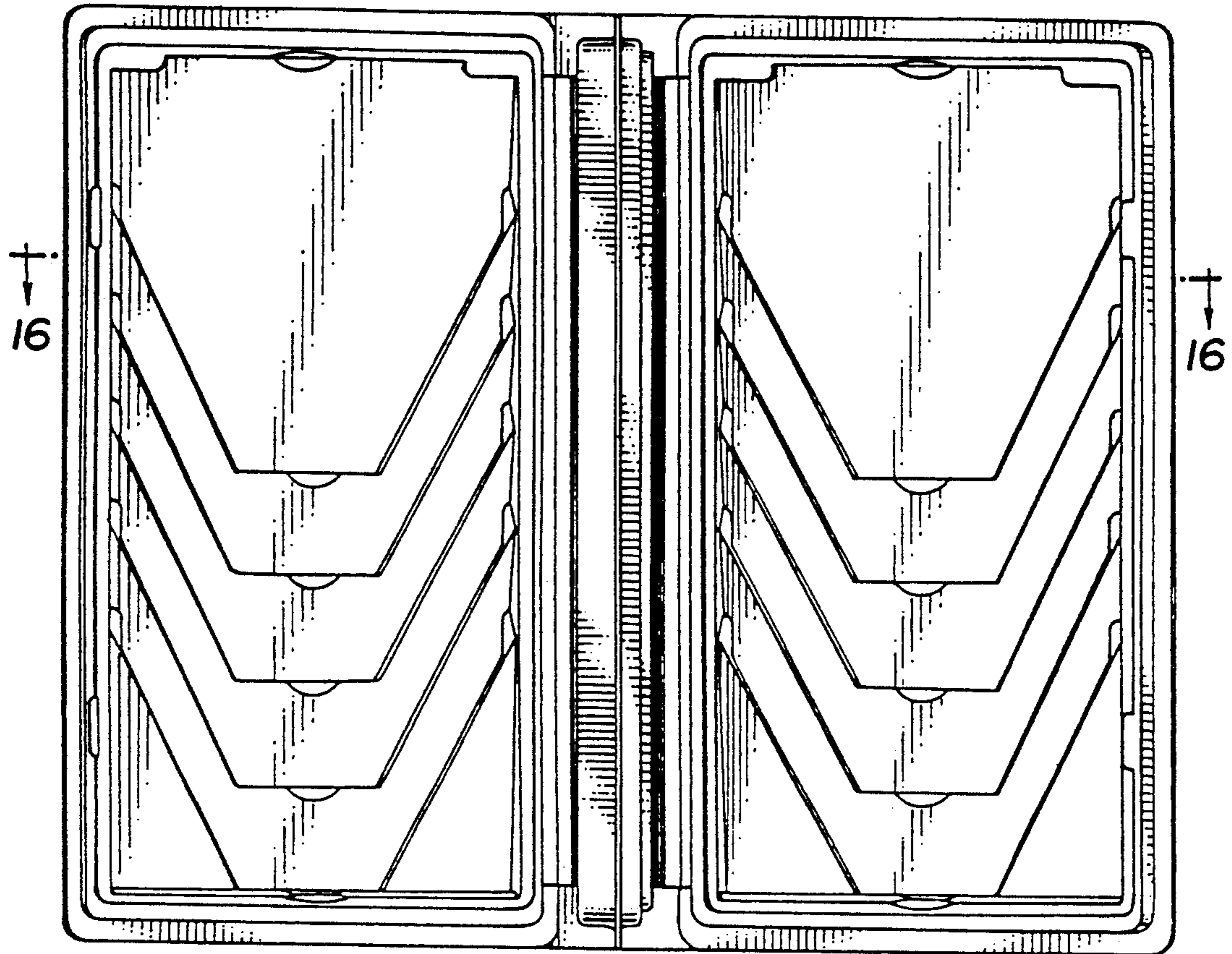

FIG. 16

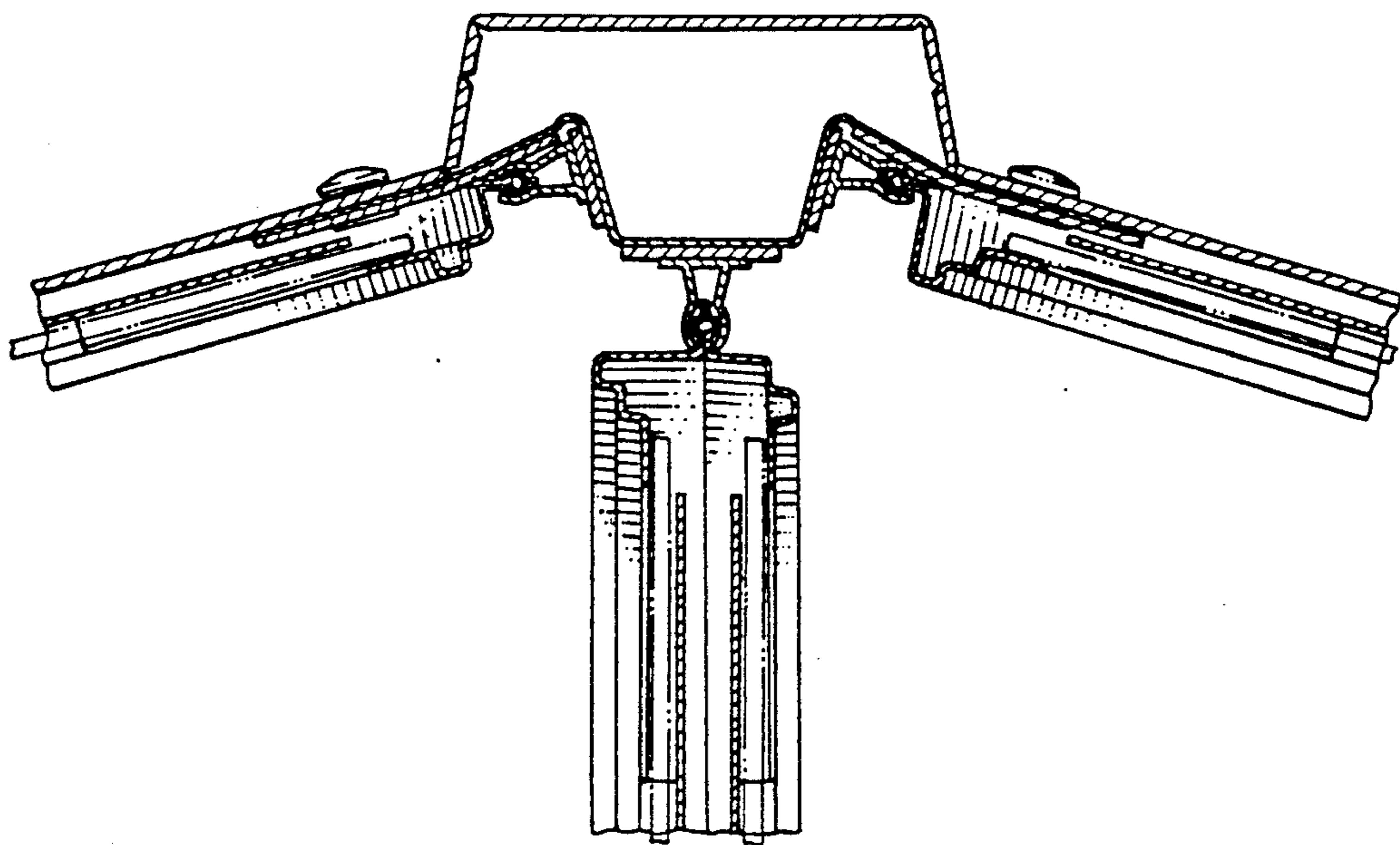

FIG. 17

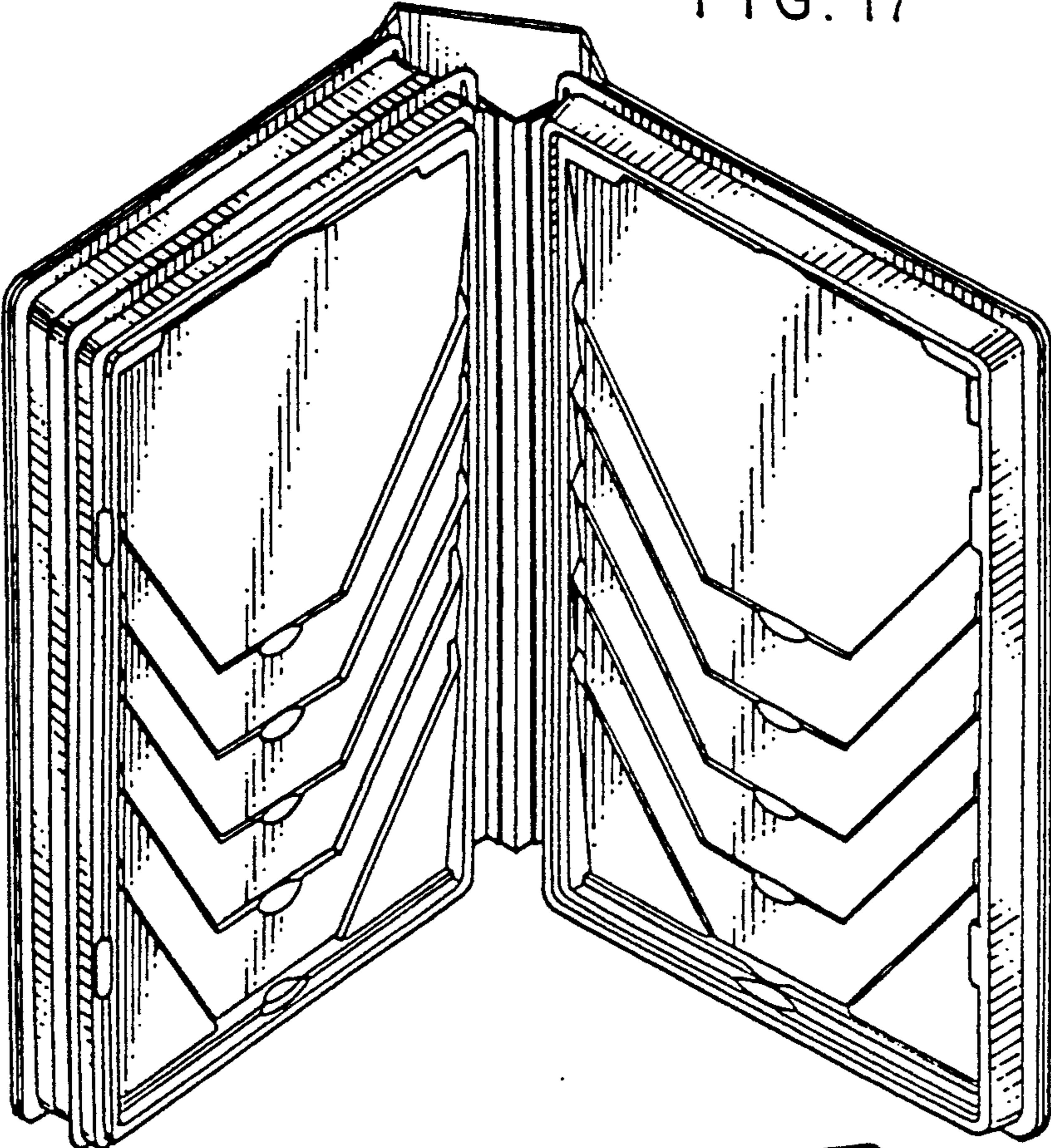

FIG. 18

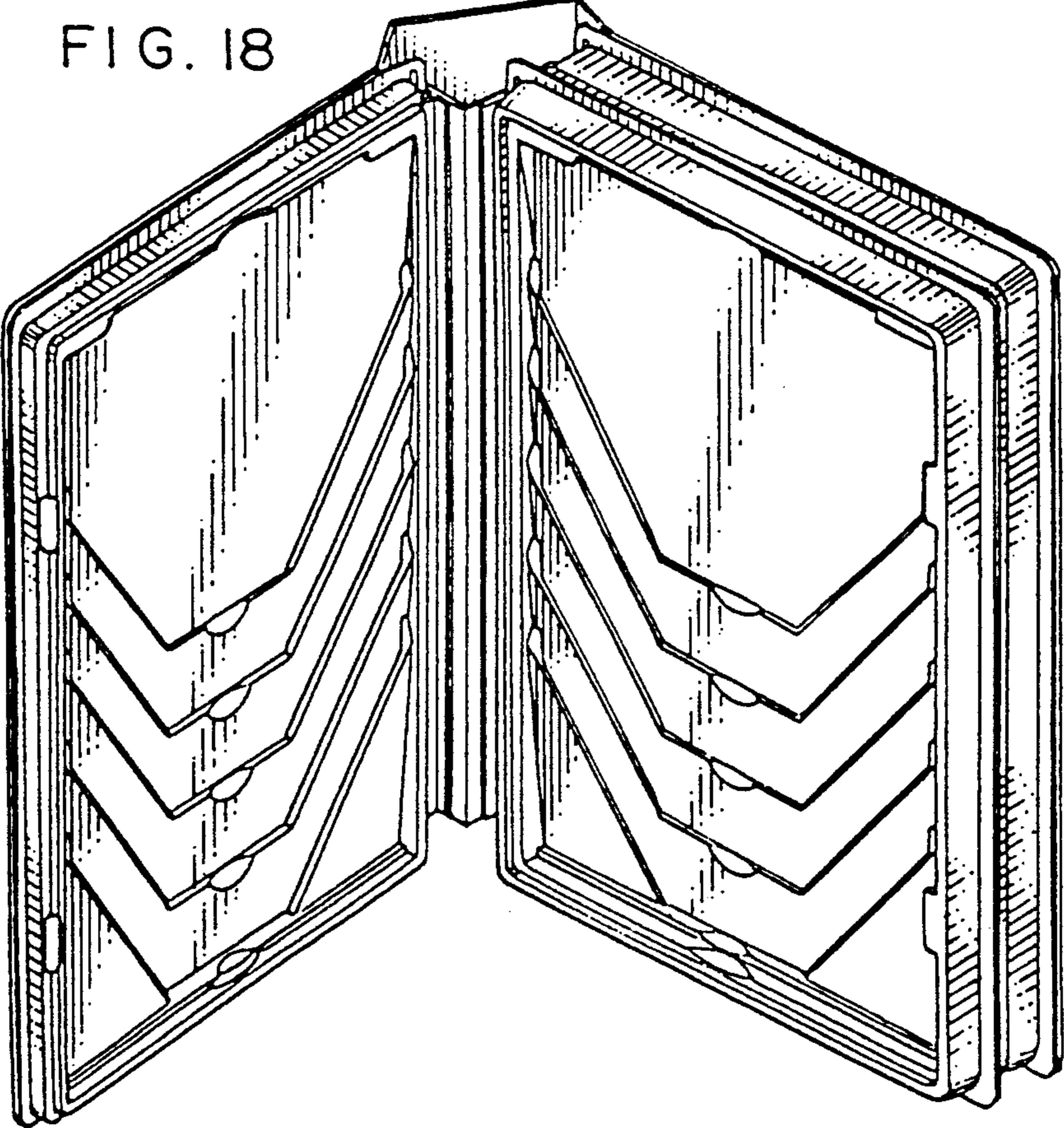

FIG. 19

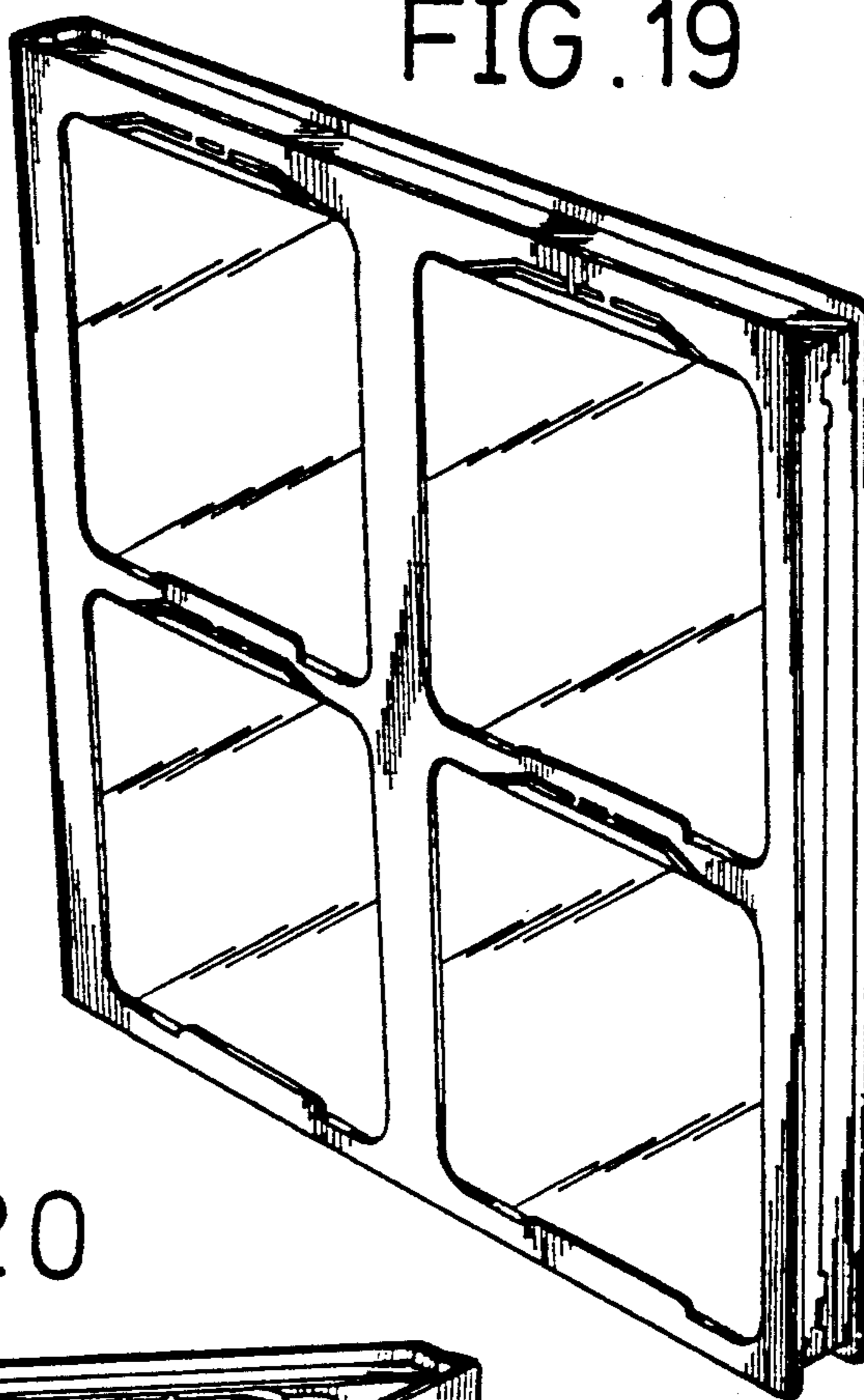
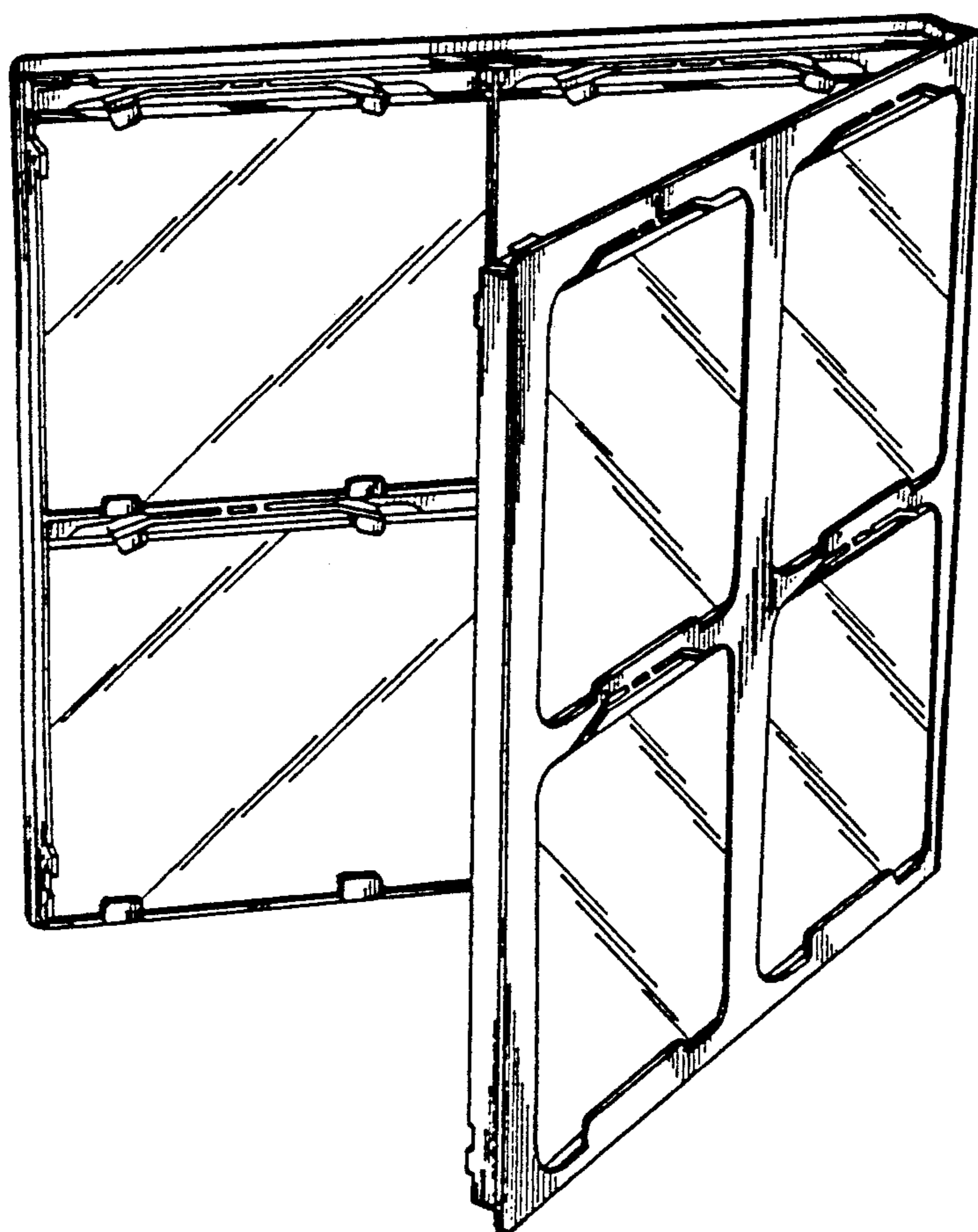

FIG. 20



UNITED STATES PATENT AND TRADEMARK OFFICE
CERTIFICATE OF CORRECTION

PATENT NO. : DES 342,655

Page 1 of 9

DATED : December 28, 1993

INVENTOR(S) : Jiro Ozeki

It is certified that error appears in the above-identified patent and that said Letters Patent is hereby corrected as shown below:

**The title page, showing the illustrative figures,
should be deleted and substitute therefore the attached title page.**

**Sheets consisting of Figures 1-18, should be deleted and substitute
therefor the attached Figures 1-18.**

Signed and Sealed this
Twenty-fifth Day of July, 1995

Attest:



BRUCE LEHMAN

Attesting Officer

Commissioner of Patents and Trademarks



US00D342655S

United States Patent [19]
Ozeki

[11] Patent Number: **Des. 342,655**
 [45] Date of Patent: **Dec. 28, 1993**

- [54] **HOLDER FOR COMPACT DISCS**
- [75] Inventor: Jiro Ozeki, Tokyo, Japan
- [73] Assignee: Slidex Corporation, Tokyo, Japan
- [**] Term: 14 Years
- [21] Appl. No.: 900,876
- [22] Filed: Jan. 18, 1992
- [30] Foreign Application Priority Data
 Dec. 25, 1991 [JP] Japan 3-39000
- [52] U.S. CL D3/35; D3/74
- [58] Field of Search D3/30.1, 35, 74;
 D6/407, 408, 457, 476; D19/26, 27, 75, 76;
 206/387, 444, 424, 311; 211/40, 41, 42

- [56] **References Cited**
- U.S. PATENT DOCUMENTS**
- D. 229,122 11/1973 Price D3/35
- D. 238,111 12/1975 Shyers D3/35
- D. 294,774 3/1988 Kitada D3/35
- D. 315,982 4/1991 Kunimune et al. D3/35
- D. 321,783 11/1991 Ozeki D3/35
- 4,760,914 8/1988 Yelardi et al. 206/387
- 4,805,769 2/1989 Soitis et al. 206/387
- 4,892,189 1/1990 Kunimune et al. 206/311
- 4,919,287 4/1990 Haskett et al. 211/41
- 5,011,016 4/1991 Ozeki 206/444
- 5,072,836 12/1991 Gross 211/40

Primary Examiner—A. Hugo Word
 Assistant Examiner—Celia A. Murphy
 Attorney, Agent, or Firm—Keck, Mahin & Cate

[57] **CLAIM**
 The ornamental design for a holder for compact discs, as shown and described.

DESCRIPTION

FIG. 1 is a front perspective view of a holder for compact discs showing my new design;
 FIG. 2 is a rear perspective view thereof;
 FIG. 3 is a front view thereof;
 FIG. 4 is a right side view thereof;
 FIG. 5 is a left side view thereof;
 FIG. 6 is a top plan view thereof;
 FIG. 7 is a bottom plan view thereof;
 FIG. 8 is a perspective view thereof shown in a partially open position;
 FIG. 9 is a perspective view thereof in a completely open position;
 FIG. 10 is a front view of FIG. 9;
 FIG. 11 is a right side view of the record disc holder shown in FIG. 10;
 FIG. 12 is a left side view of the record disc holder shown in FIG. 10;
 FIG. 13 is a rear view of the record disc holder shown in FIG. 10;
 FIG. 14 is a top plan view of the record disc holder shown in FIG. 10;
 FIG. 15 is a bottom view of the record disc holder shown in FIG. 10;
 FIG. 16 is an enlarged fragmentary view of a right upper corner of the holder for compact discs shown in FIG. 3;
 FIG. 17 is a cross-sectional view taken along line 17—17 of FIG. 16;
 FIG. 18 is a cross-sectional view taken along line 18—18 of FIG. 16;
 FIG. 19 is a perspective view thereof shown in use, the broken lines showing compact discs being for illustrative purposes only and forming no part of the claimed design; and
 FIG. 20 is a rear perspective view of FIG. 19.

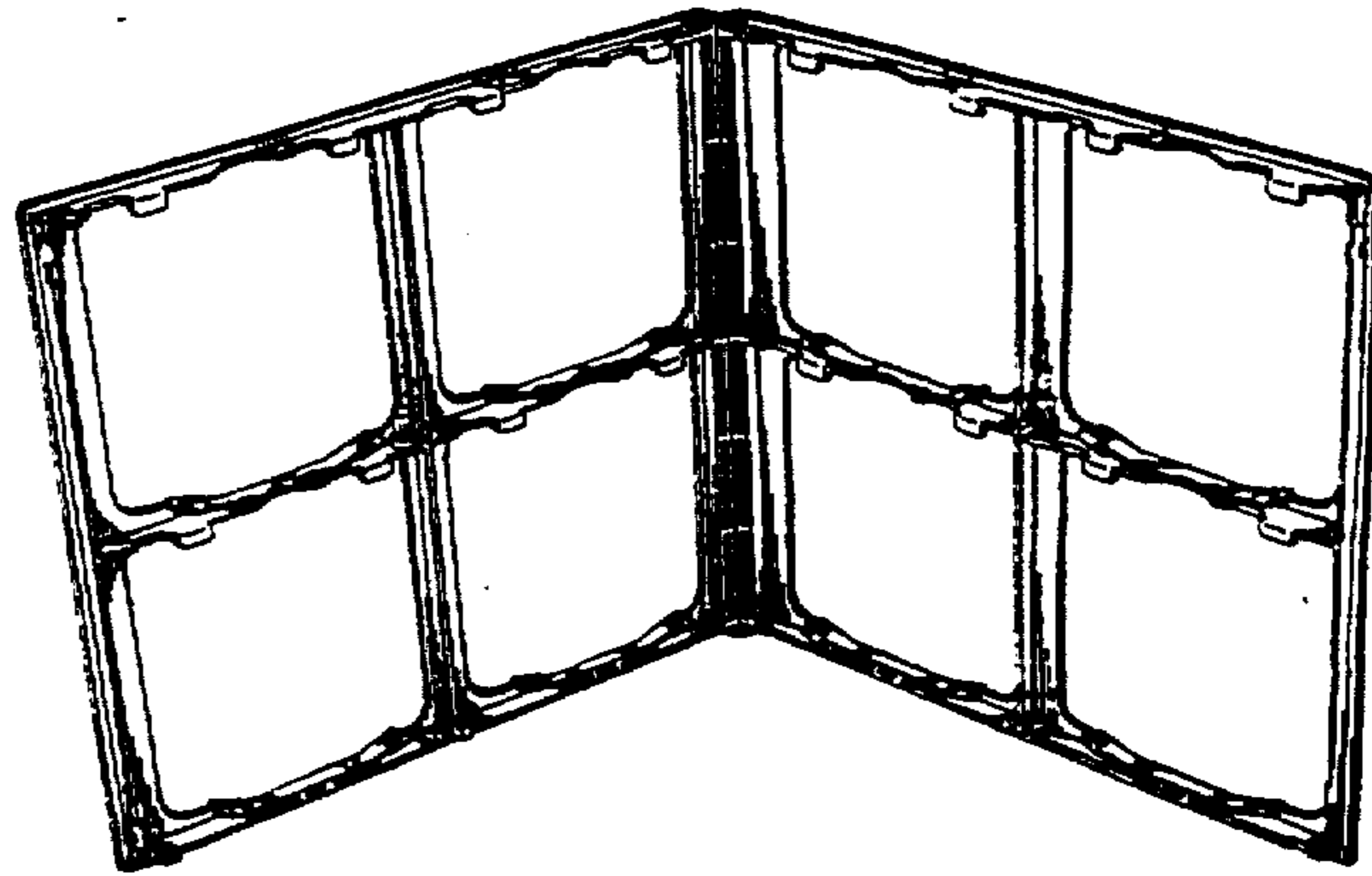
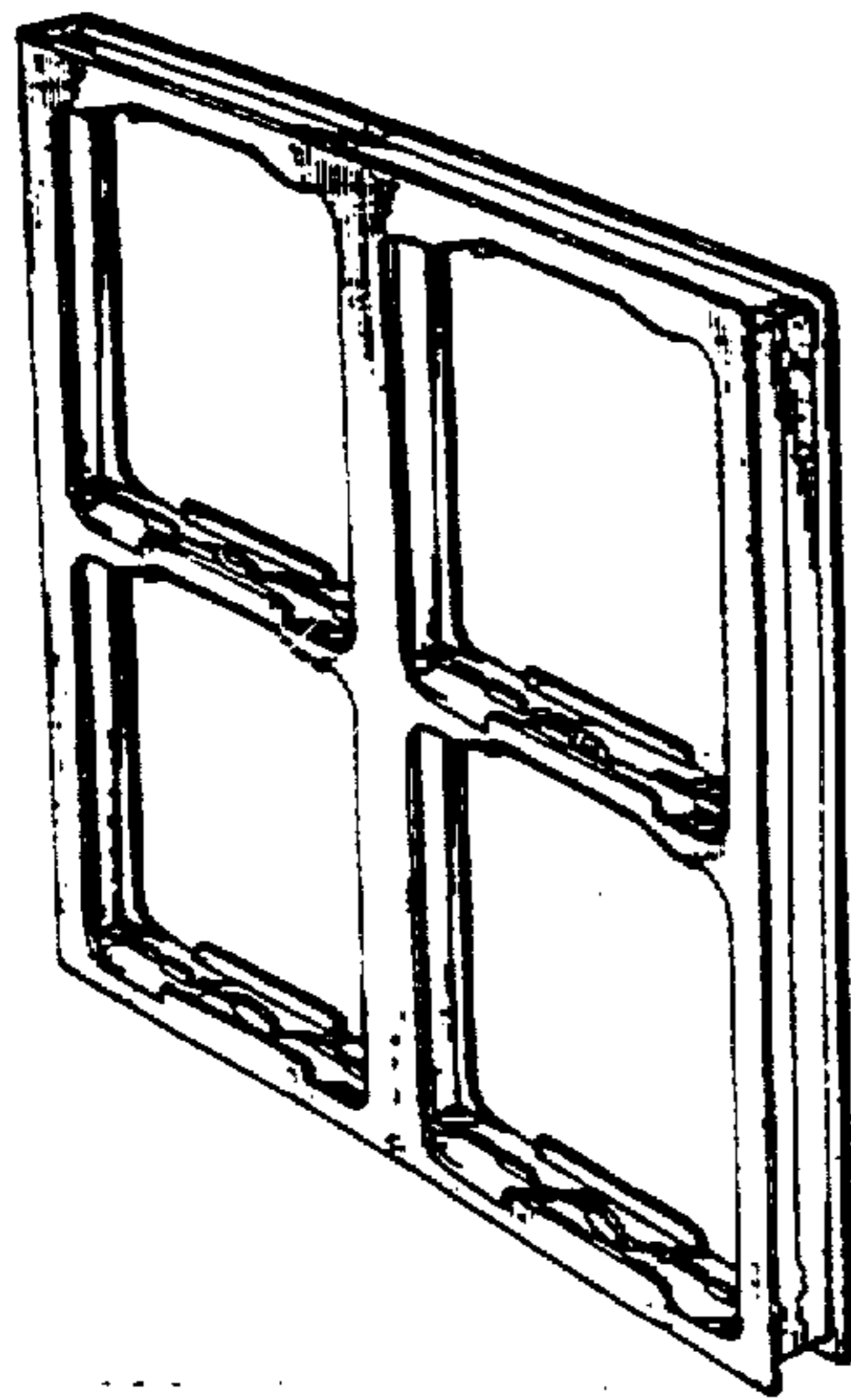

FIG. 1

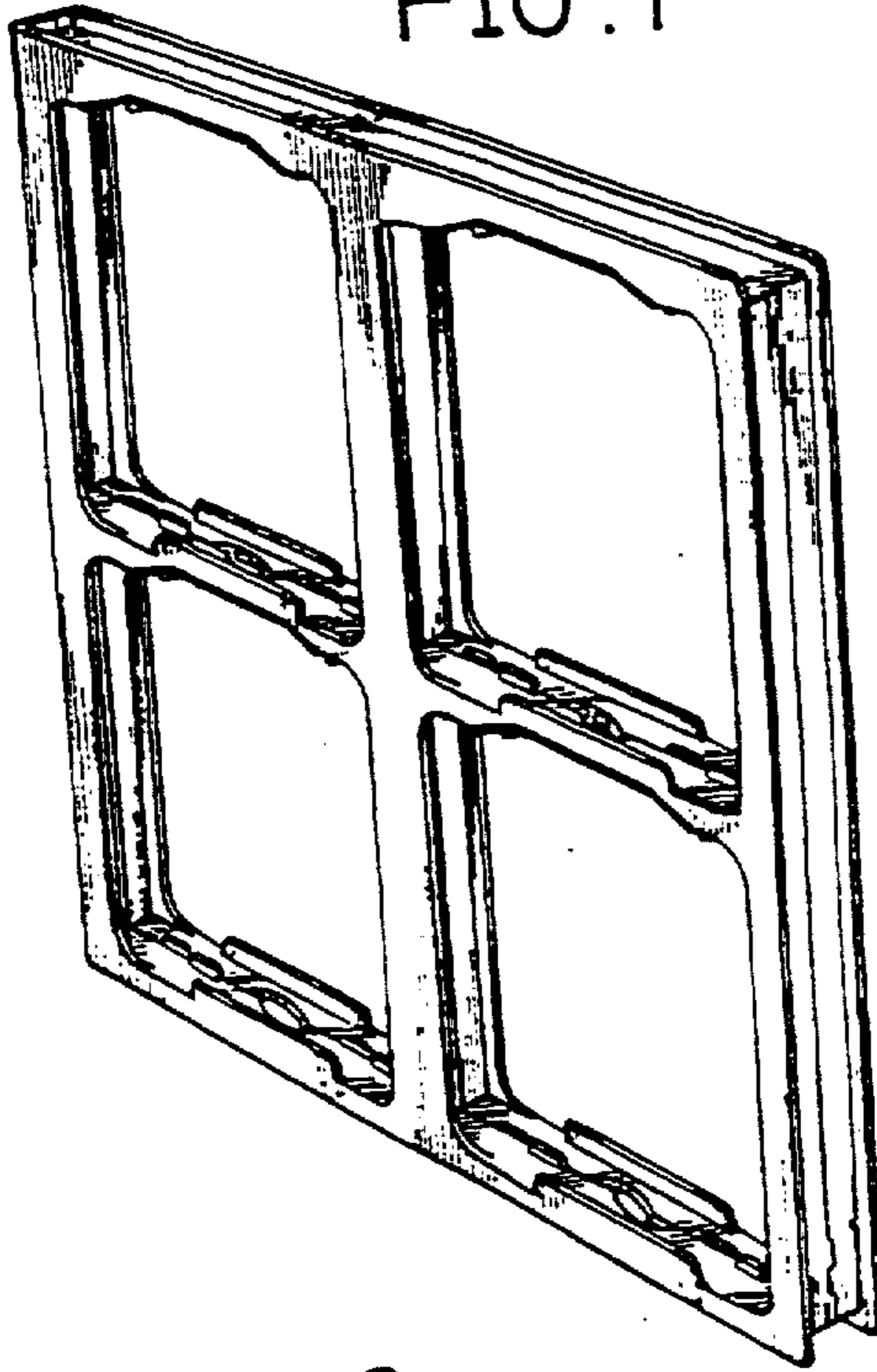

FIG. 2

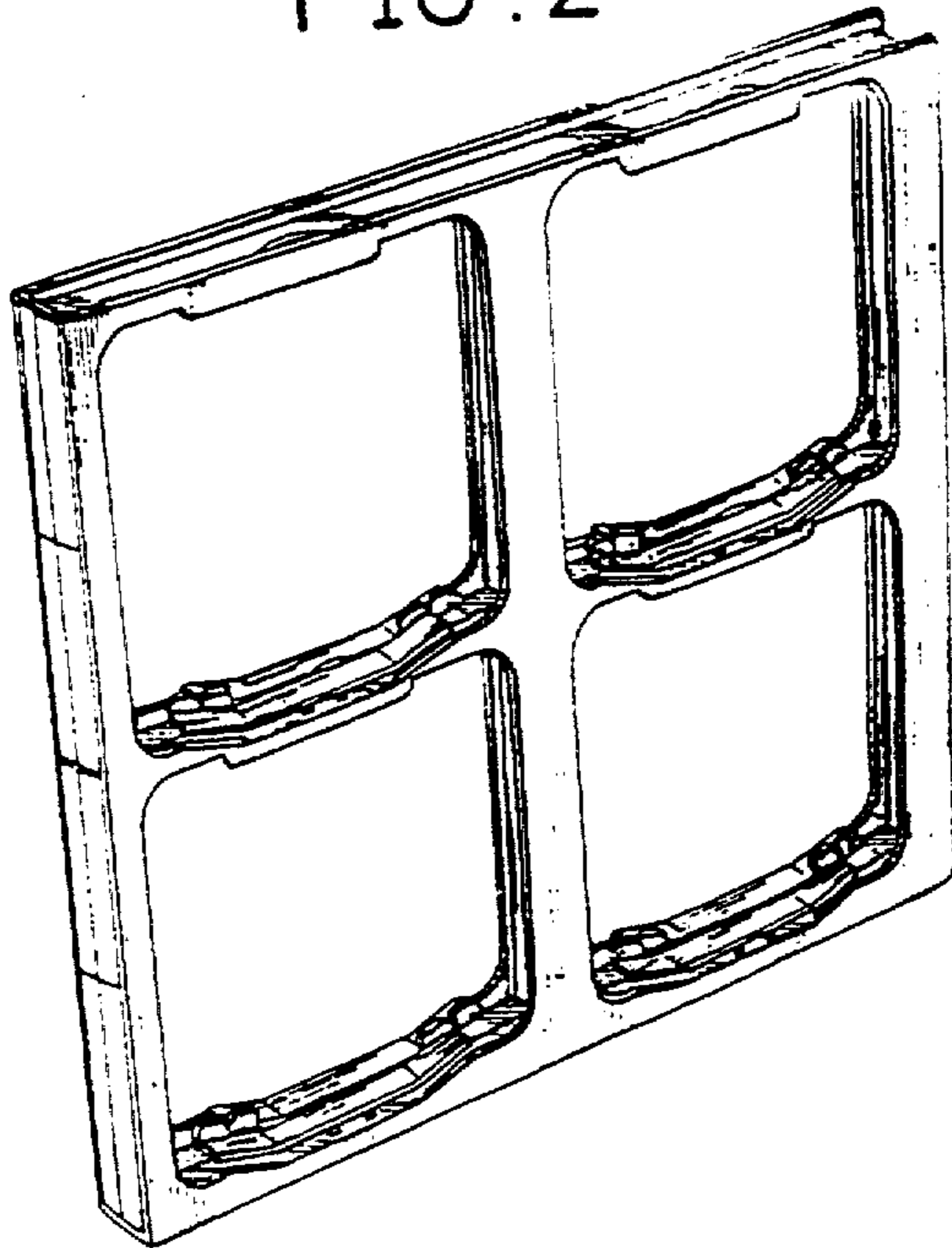

FIG. 3

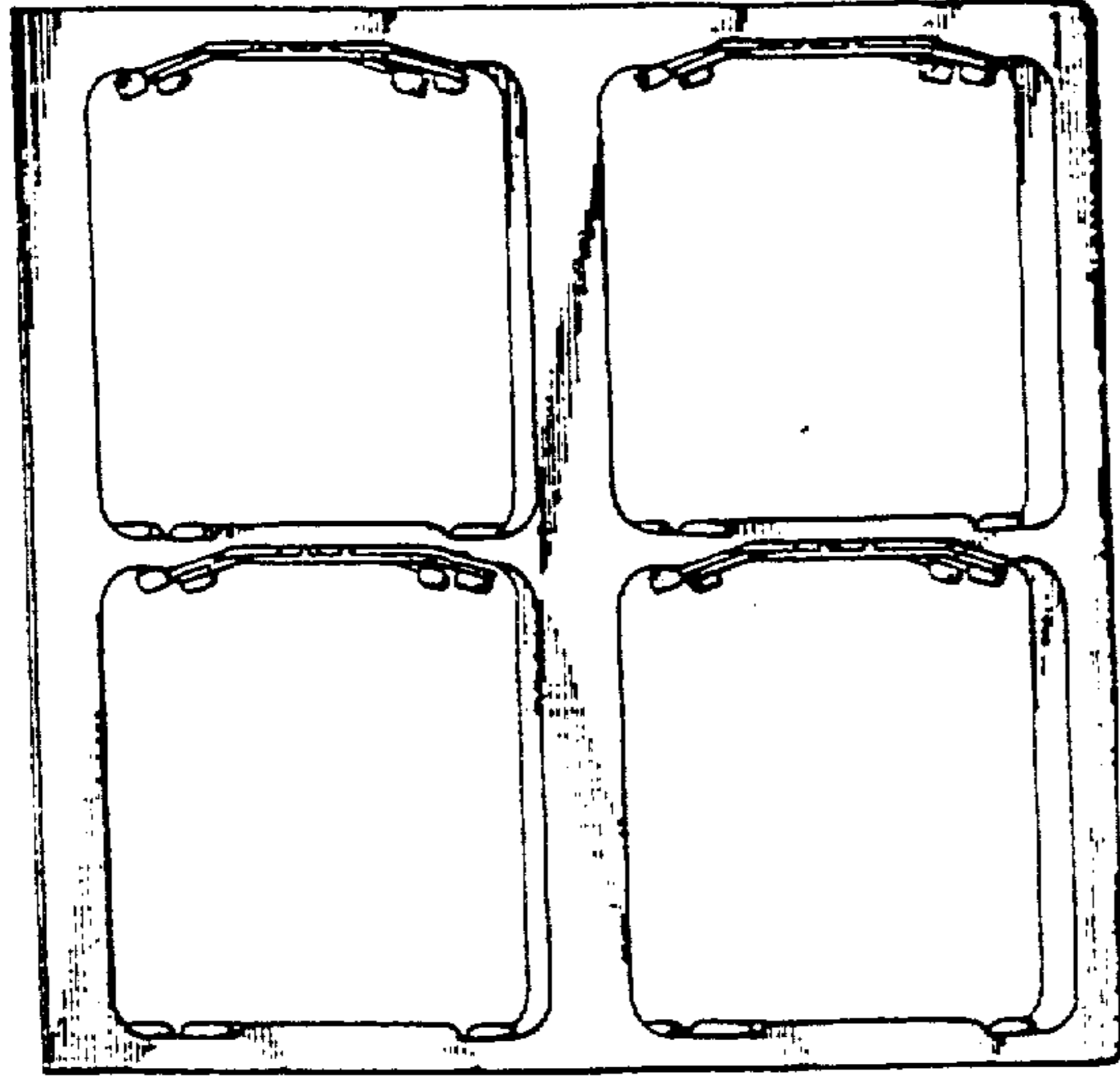

FIG. 4

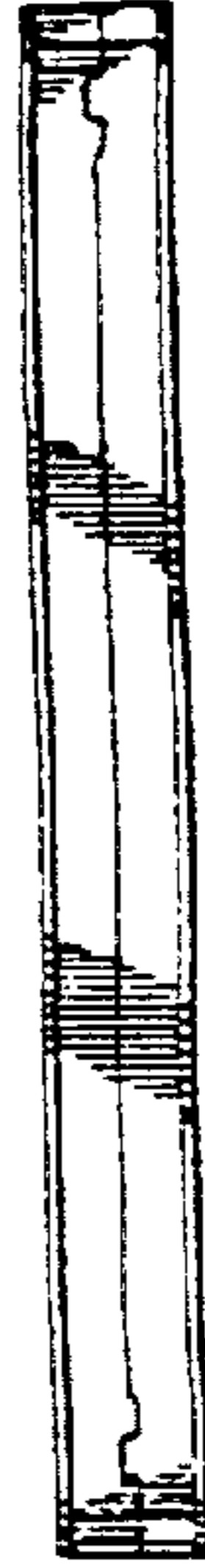

FIG. 6

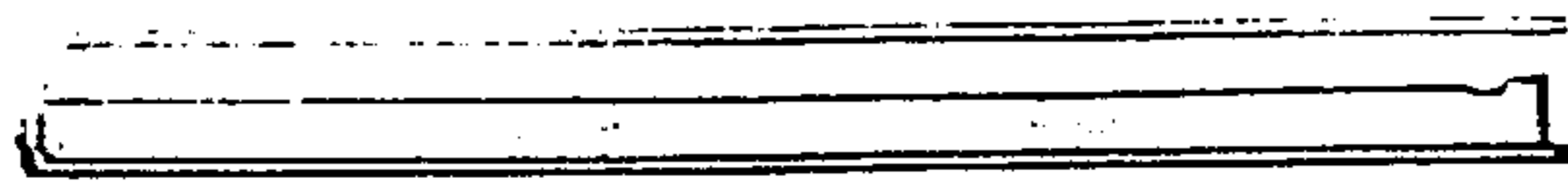

FIG. 5



FIG. 7

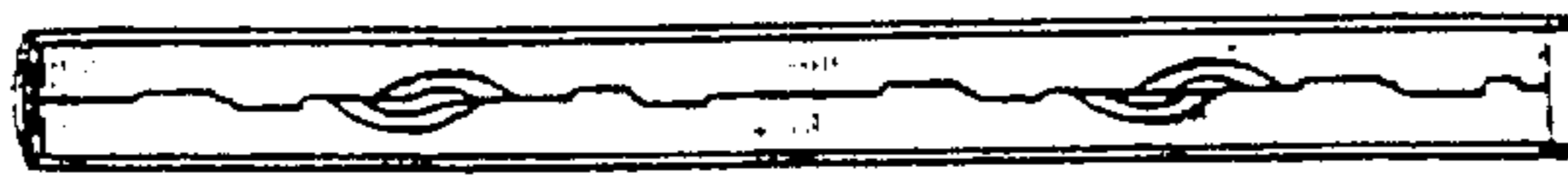

FIG. 8

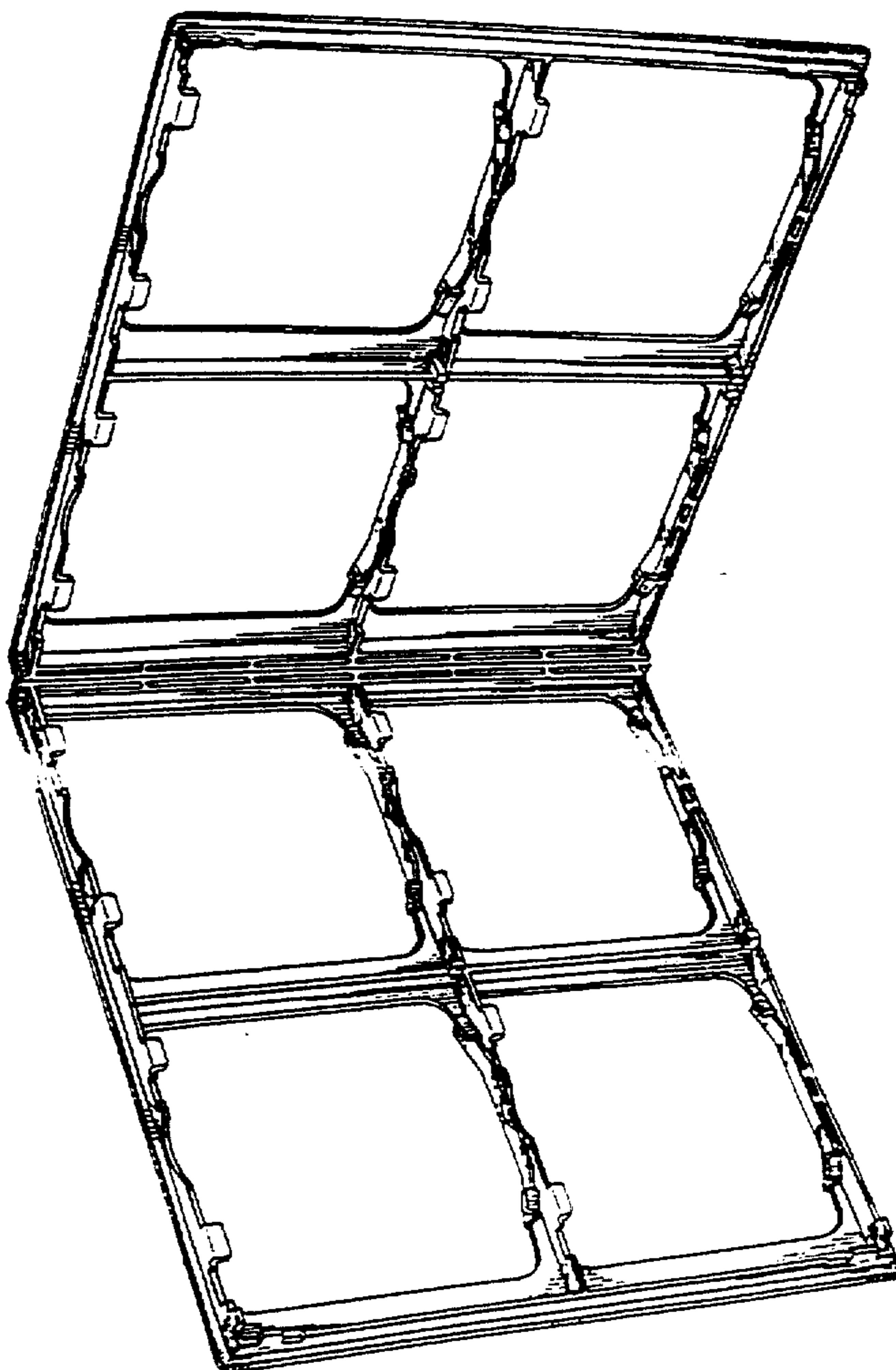

FIG. 9

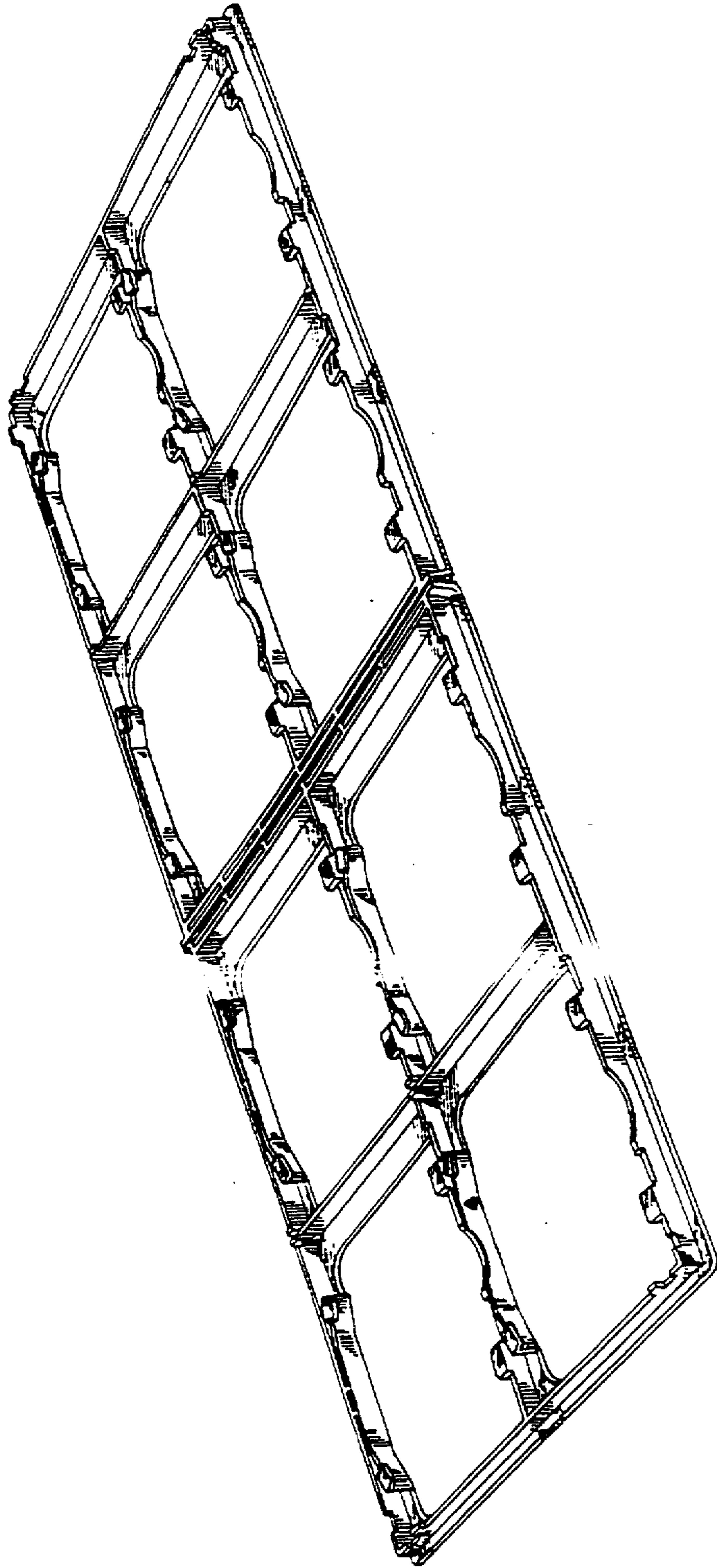

FIG.11

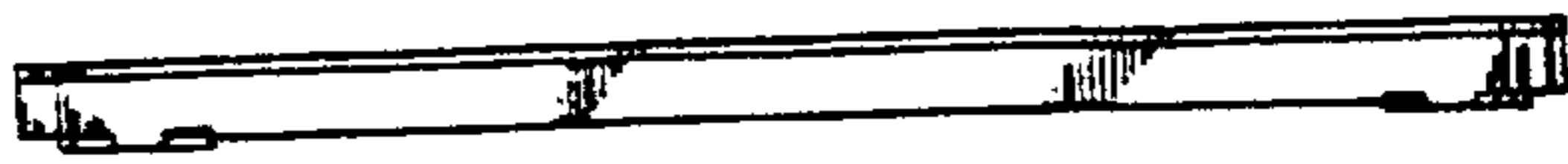

FIG.10

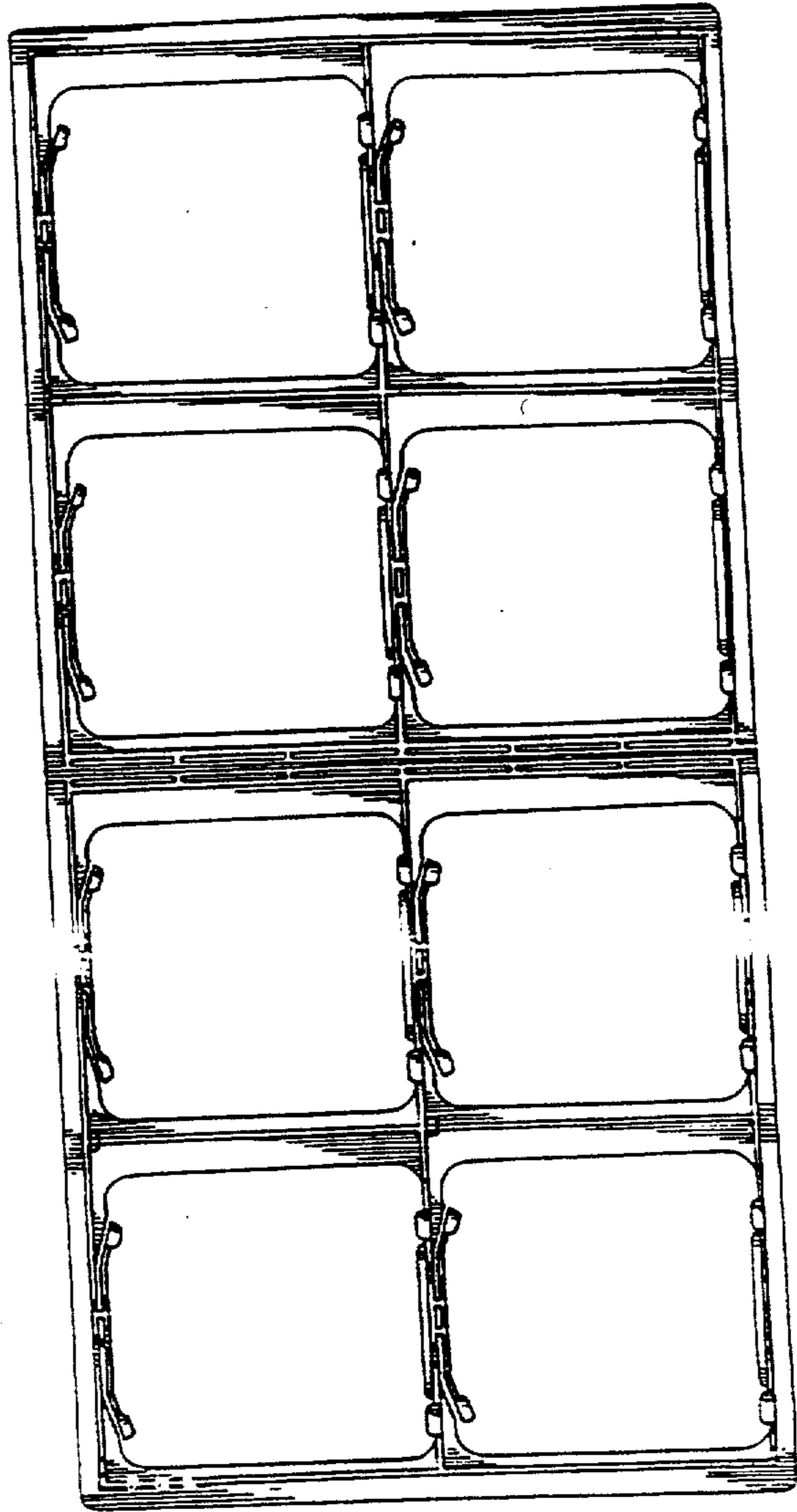

FIG.12

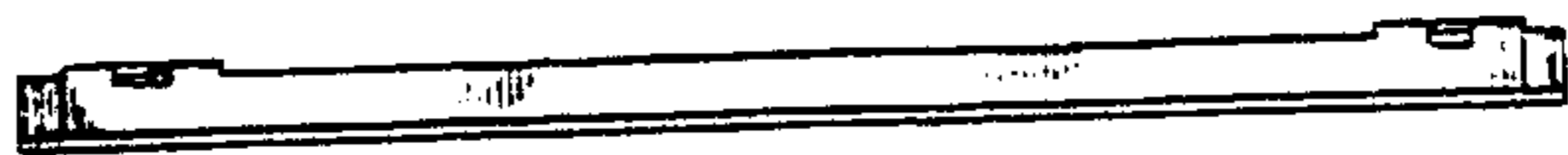

FIG.13

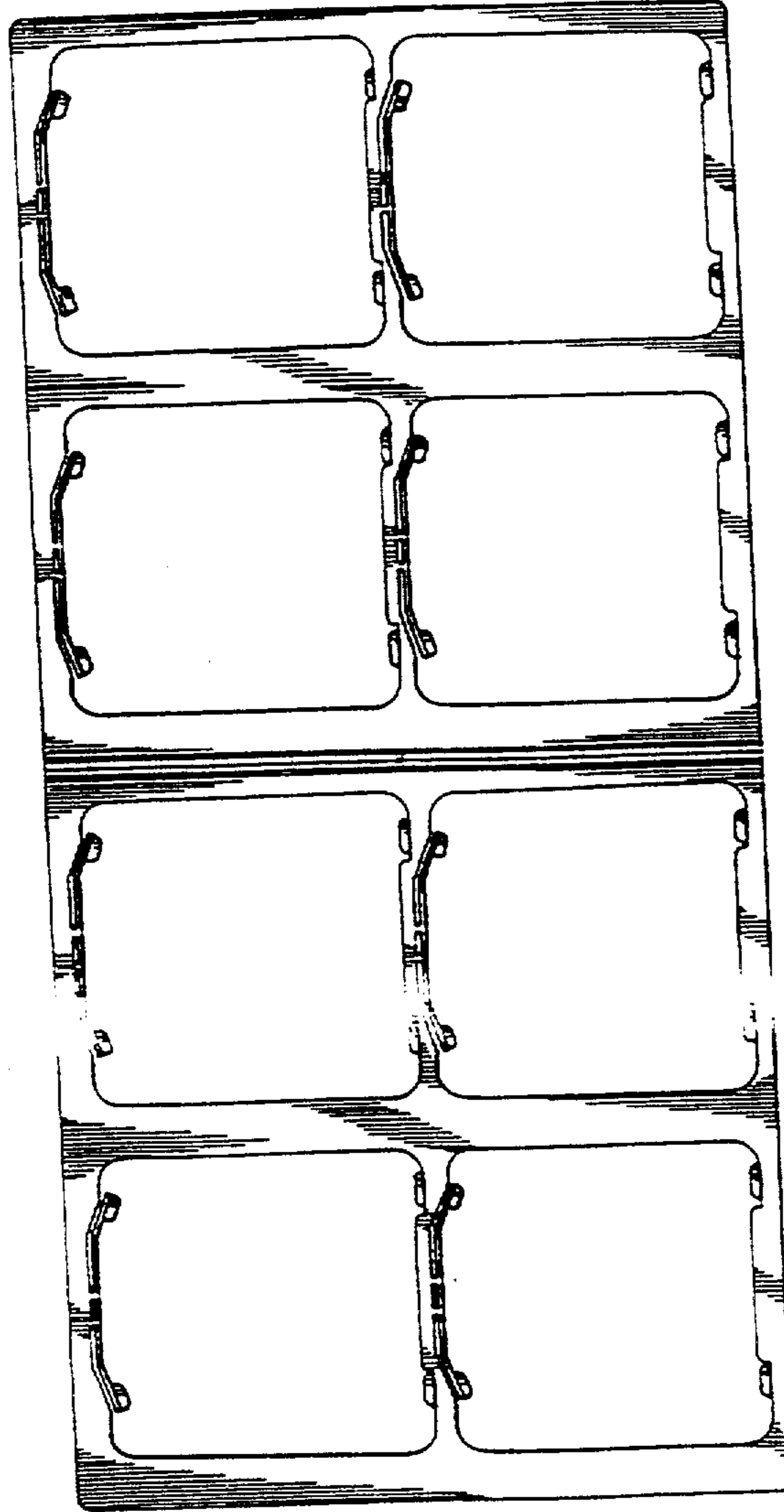

FIG.14



FIG.15

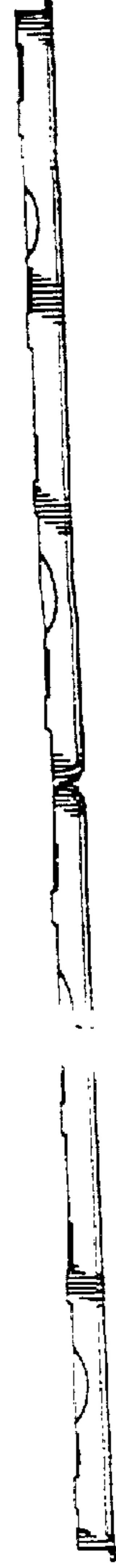

FIG. 16

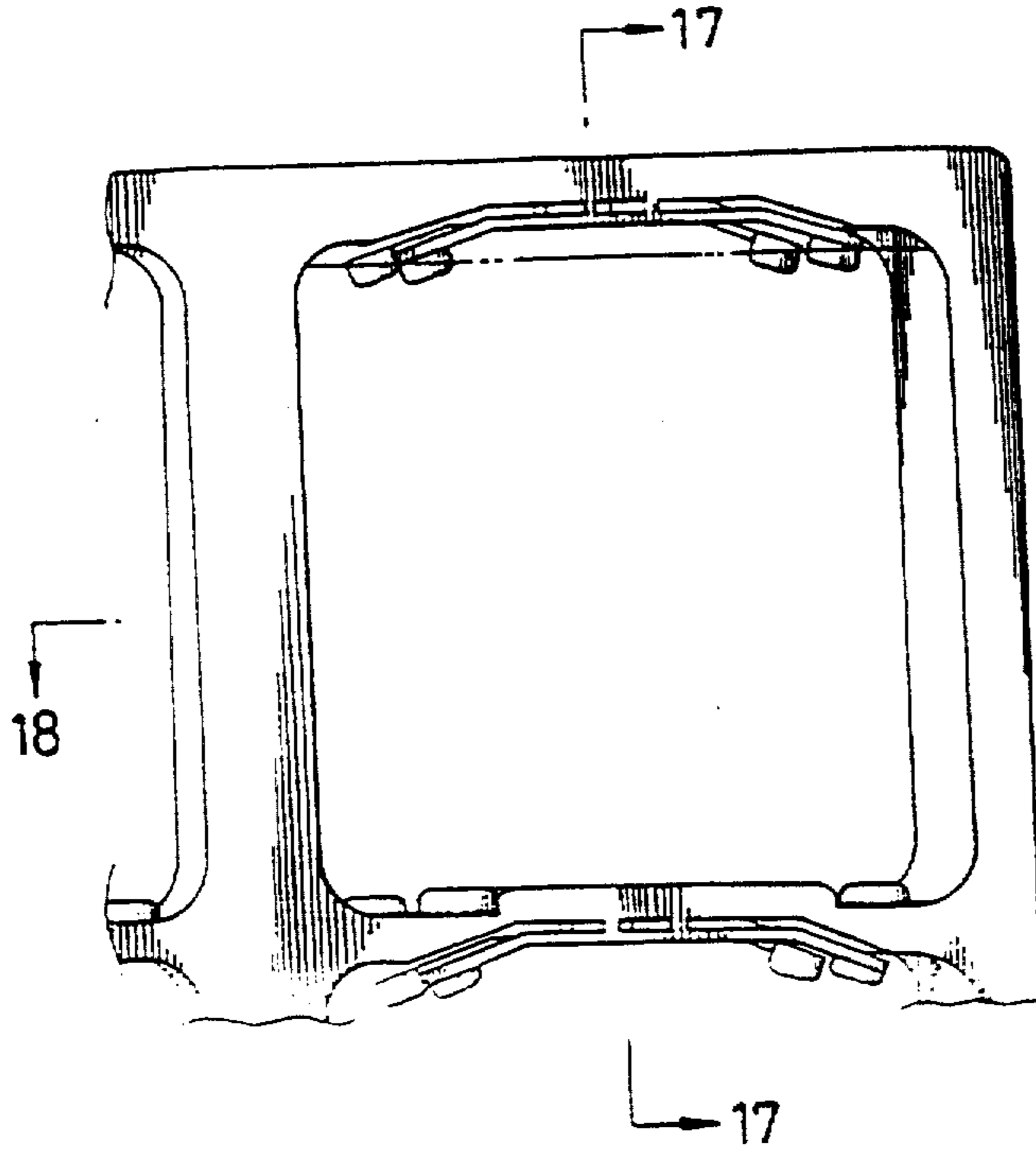

FIG. 17

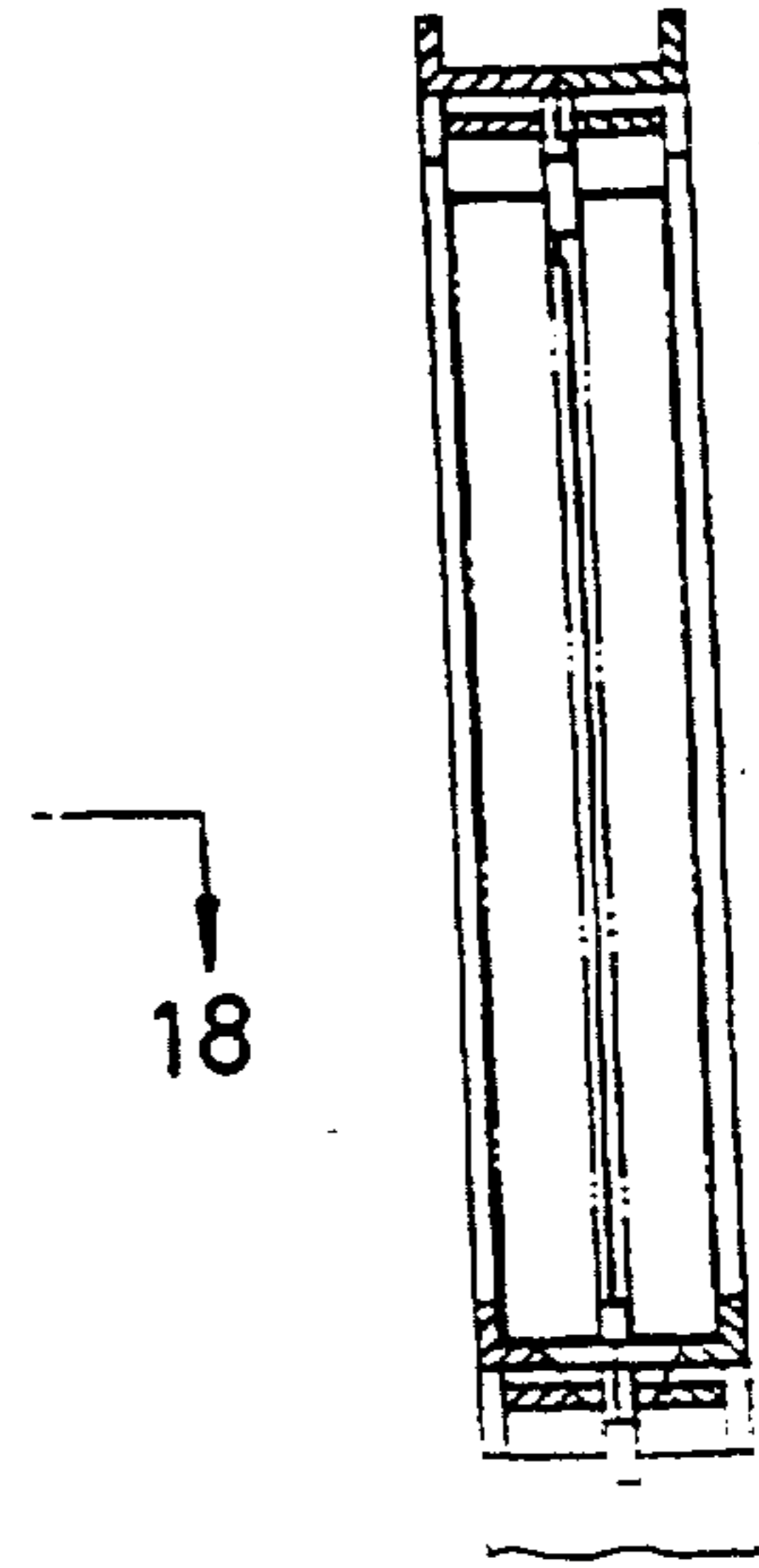

FIG. 18

