



US00D342580S

# United States Patent [19] Harrison

[11] Patent Number: Des. 342,580  
[45] Date of Patent: \*\* Dec. 21, 1993

- [54] **RETAINING WALL BLOCK**
- [75] Inventor: **Cloyce D. Harrison**, Albuquerque, N. Mex.
- [73] Assignee: **CSTW, Inc.**, Albuquerque, N. Mex.
- [\*] Notice: The portion of the term of this patent subsequent to Nov. 2, 2007 has been disclaimed.
- [\*\*] Term: **14 Years**
- [21] Appl. No.: **937,042**
- [22] Filed: **Aug. 27, 1992**
- [52] U.S. Cl. .... **D25/118**
- [58] Field of Search ..... **D25/114-118; 52/590-596, 605, 608, 602, 610; 405/284**

2,624,193	1/1953	Larson .....	D25/118
4,335,549	6/1982	Dean, Jr. ....	52/98
4,854,103	8/1989	Klym .....	52/593
4,914,876	4/1990	Forsberg .....	52/169.4
4,920,712	5/1990	Dean, Jr. ....	52/169.4

### FOREIGN PATENT DOCUMENTS

1169265 6/1984 Canada .

*Primary Examiner*—A. Hugo Word  
*Assistant Examiner*—Doris Clark  
*Attorney, Agent, or Firm*—Dennis F. Armijo; Deborah A. Peacock

### [57] CLAIM

The ornamental design for a retaining wall block, as shown and described.

### [56] References Cited

#### U.S. PATENT DOCUMENTS

D. 276,081	10/1984	Rassias et al. ....	D25/114
D. 295,788	5/1988	Forsberg .....	D25/113
D. 295,790	5/1988	Forsberg .....	D25/116
D. 296,007	5/1988	Forsberg .....	D25/116
D. 296,365	6/1988	Forsberg .....	D25/116
D. 297,464	8/1988	Forsberg .....	D25/114
D. 297,574	9/1988	Forsberg .....	D25/114
D. 297,767	9/1988	Forsberg .....	D25/58
D. 298,463	11/1988	Forsberg .....	D25/114
D. 299,067	12/1988	Forsberg .....	D25/58
D. 300,253	3/1989	Forsberg .....	D25/114
D. 300,254	3/1989	Forsberg .....	D25/114
D. 301,064	5/1989	Forsberg .....	D25/116
D. 311,444	10/1990	Forsberg .....	D25/113
2,140,773	12/1938	Slayter et al. ....	52/596
2,610,503	9/1952	Hall .....	D25/118

### DESCRIPTION

FIG. 1 is a left side perspective view of a first embodiment of the retaining wall block of my new design;  
 FIG. 2 is a top view thereof;  
 FIG. 3 is a side view of the left side thereof;  
 FIG. 4 is a front elevational view thereof;  
 FIG. 5 is a side view of the right side thereof;  
 FIG. 6 is a rear elevational view thereof;  
 FIG. 7 is a bottom view thereof;  
 FIG. 8 is a left side perspective view of a second embodiment of the retaining wall block of my new design;  
 FIG. 9 is a top view of the embodiment of FIG. 8;  
 FIG. 10 is a side view of the left side of FIG. 8;  
 FIG. 11 is a front elevational view of FIG. 8;  
 FIG. 12 is a side view of the right side of FIG. 8;  
 FIG. 13 is a rear elevational view of FIG. 8; and,  
 FIG. 14 is a bottom view of FIG. 8.

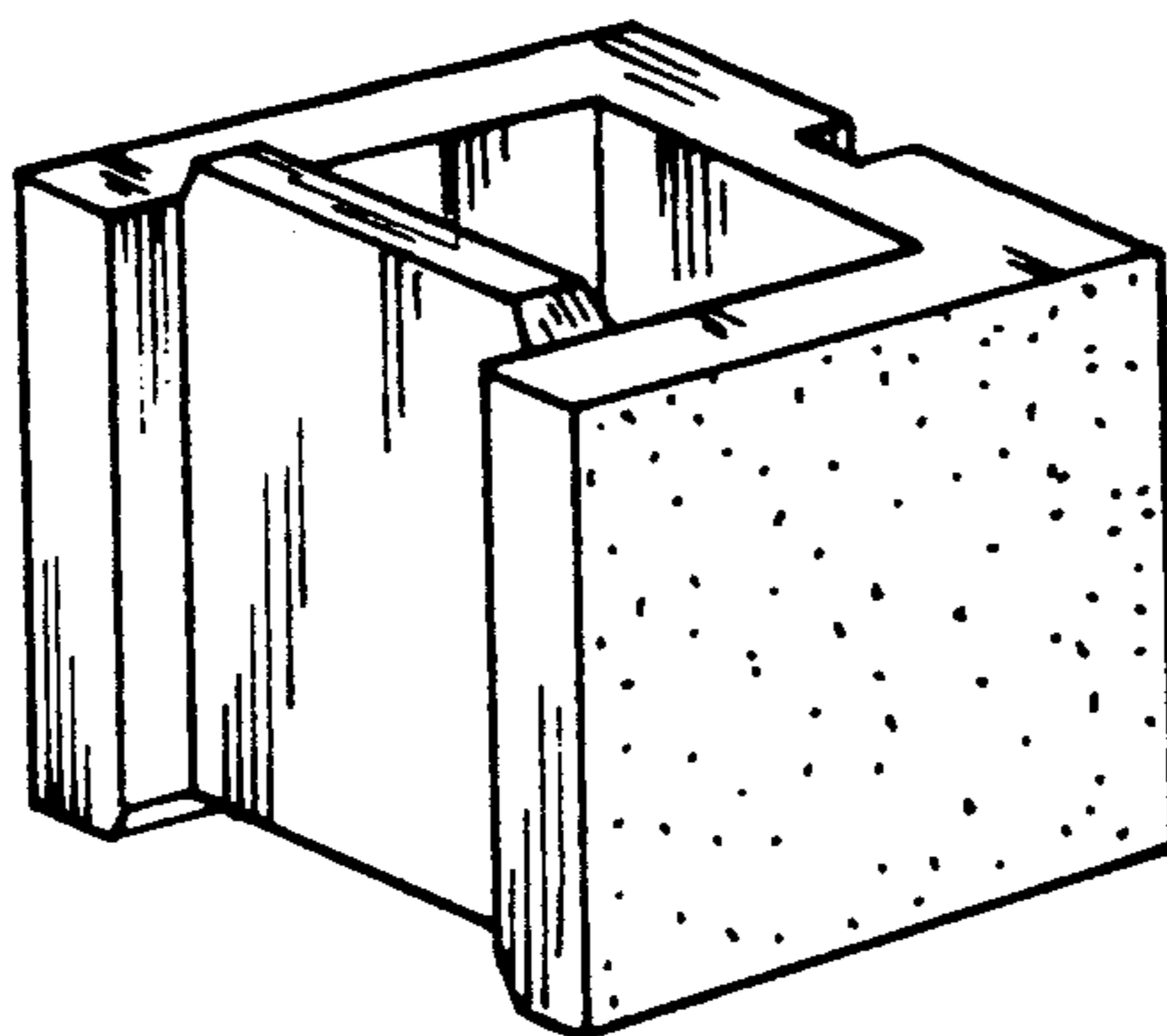

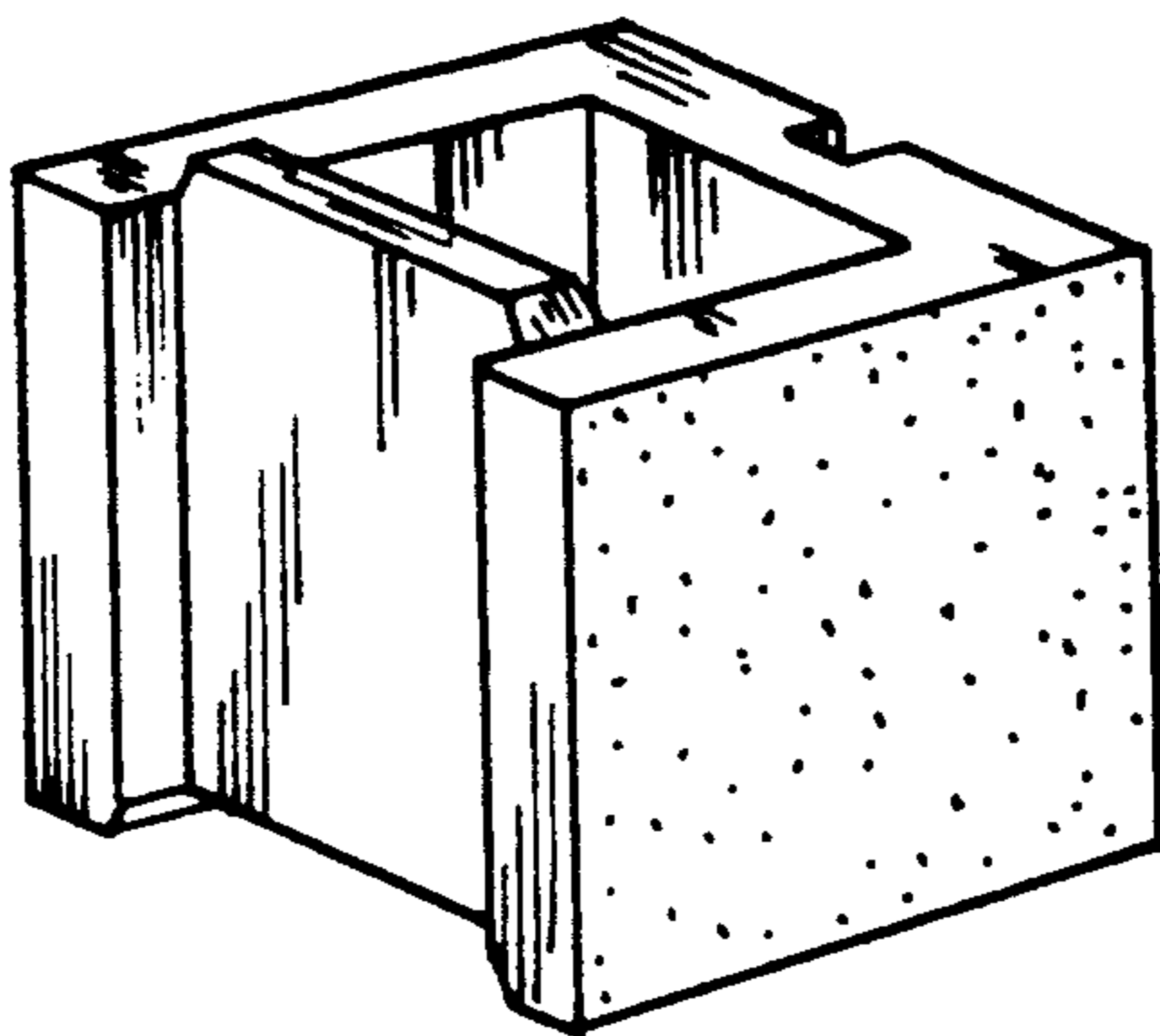

FIG-1

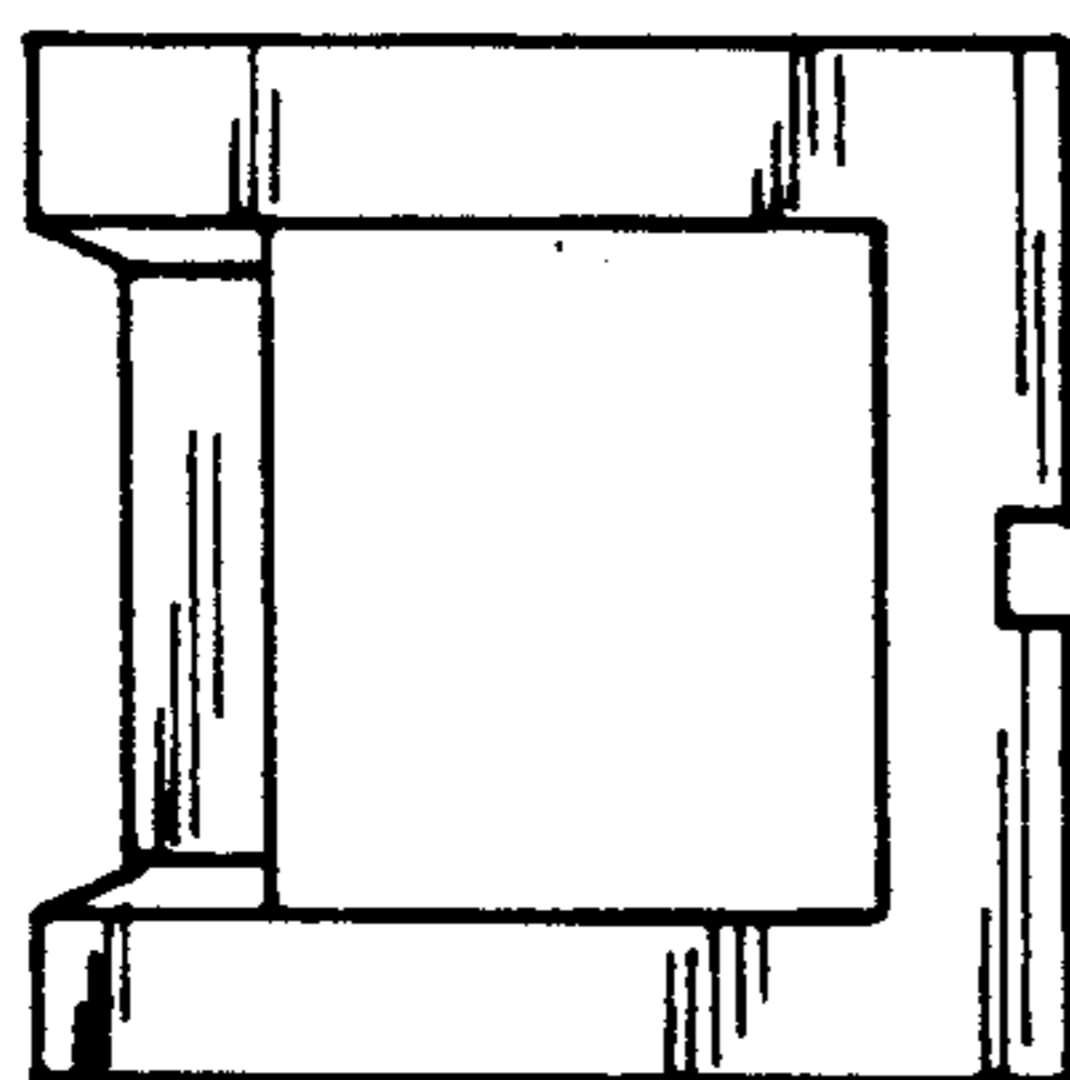

FIG-2

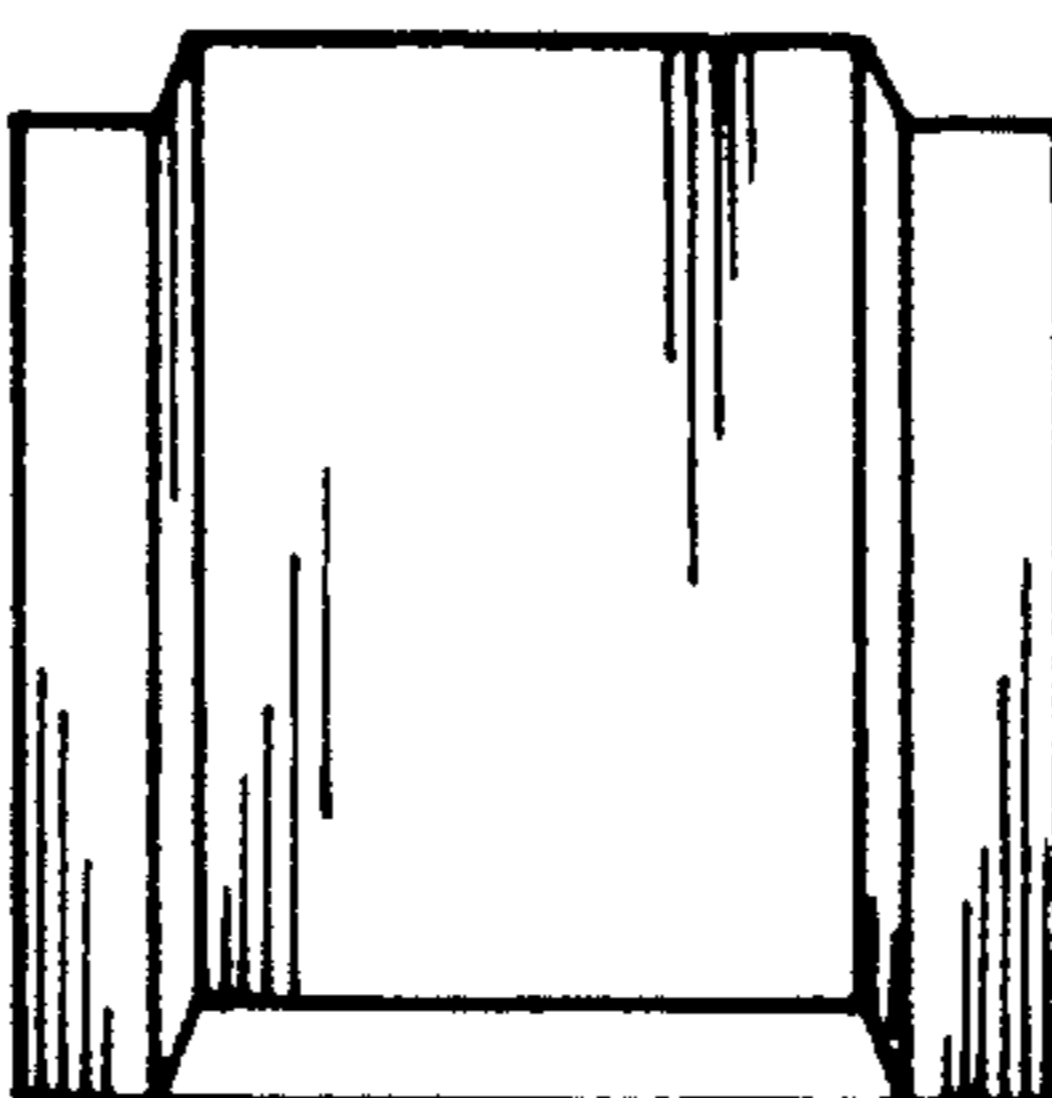

FIG-3

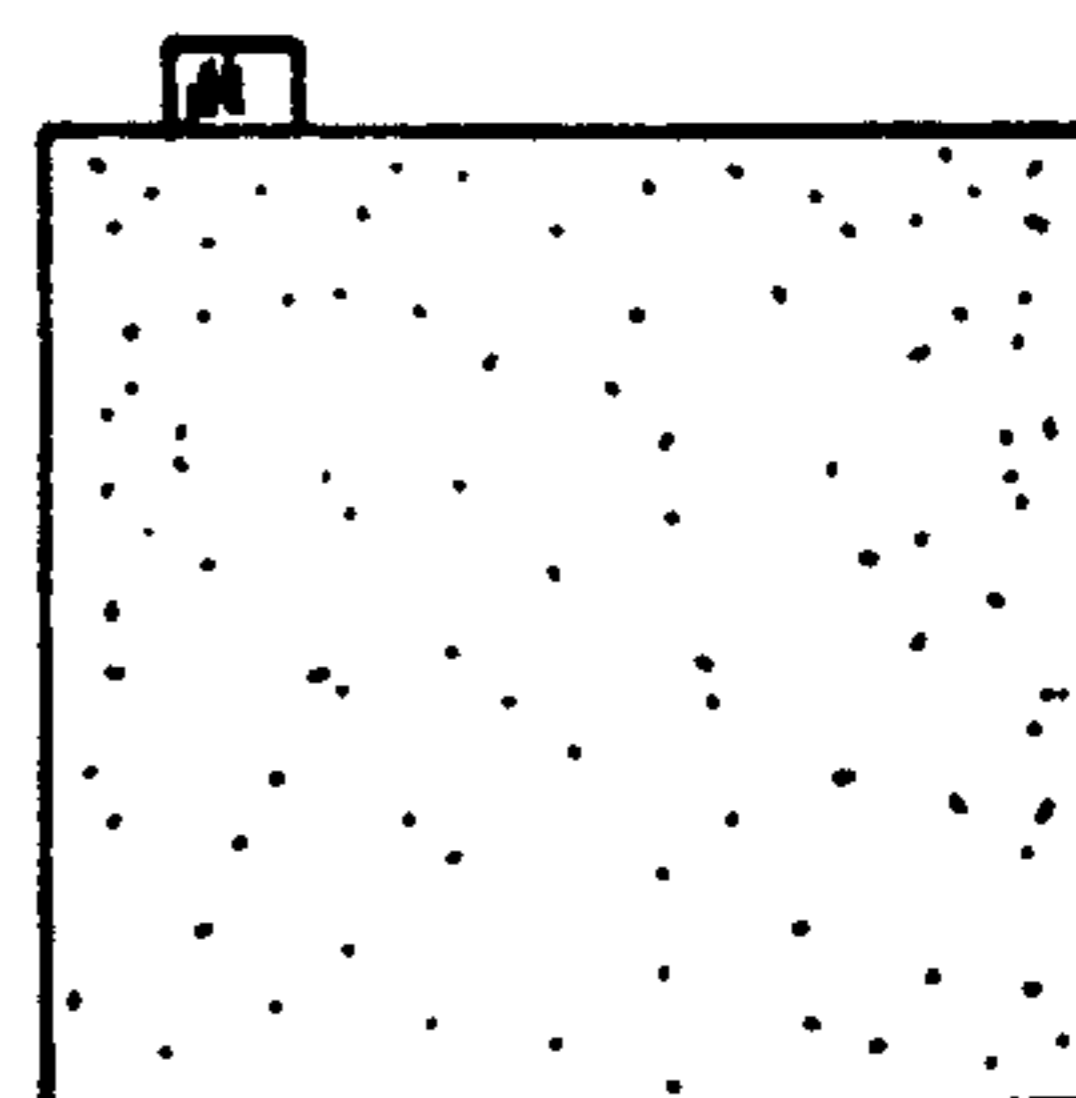

FIG-4

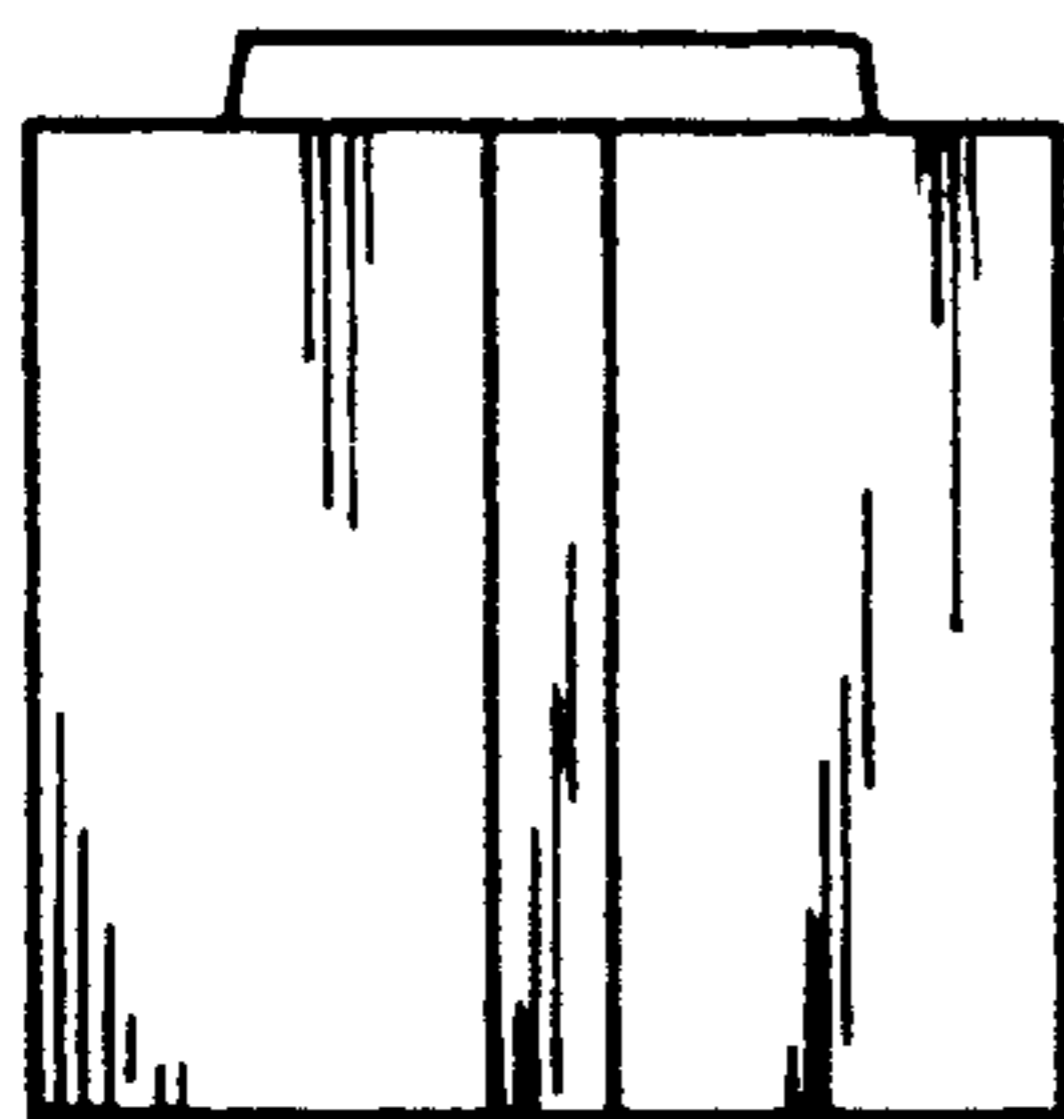

FIG-5

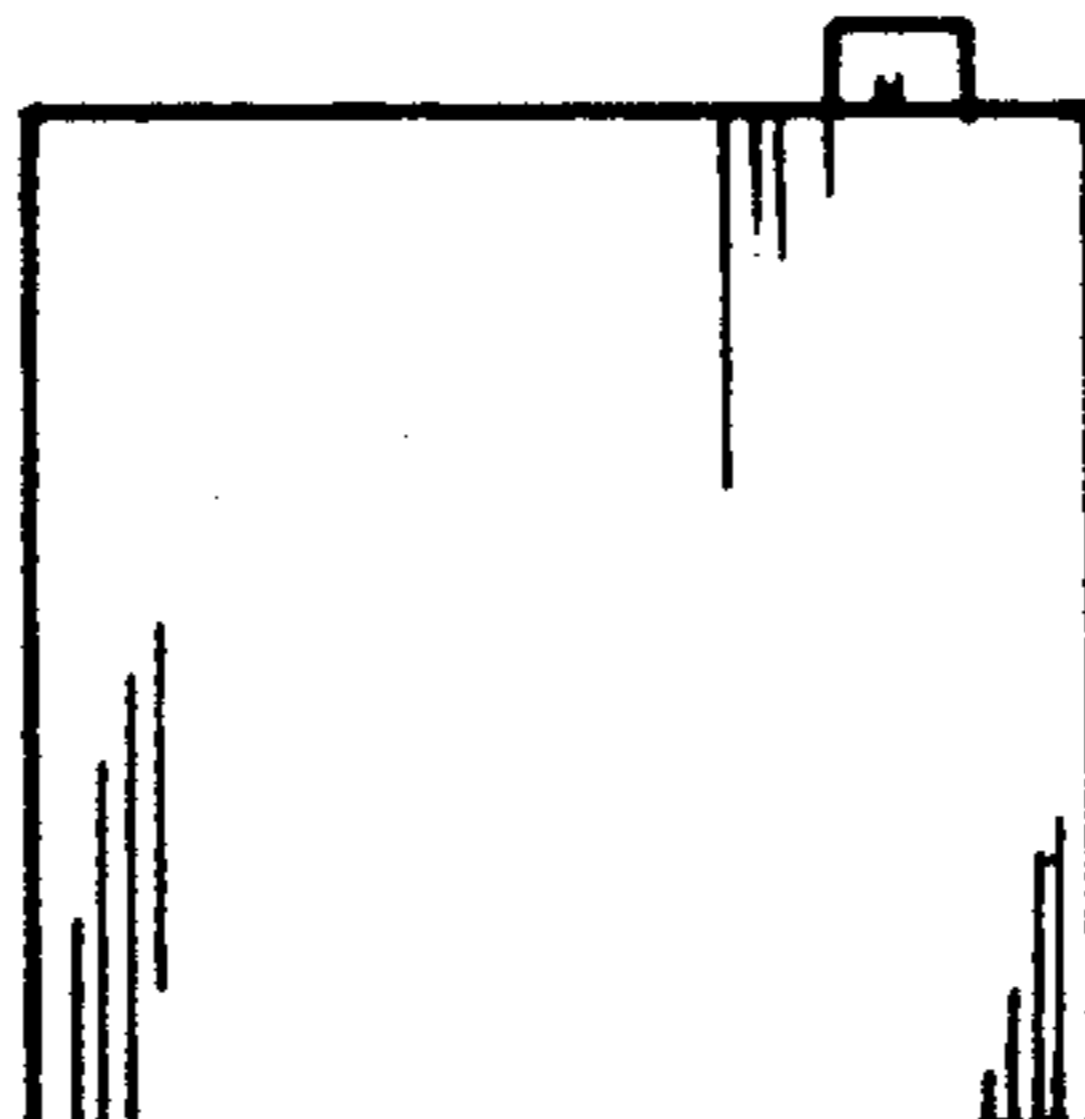

FIG-6

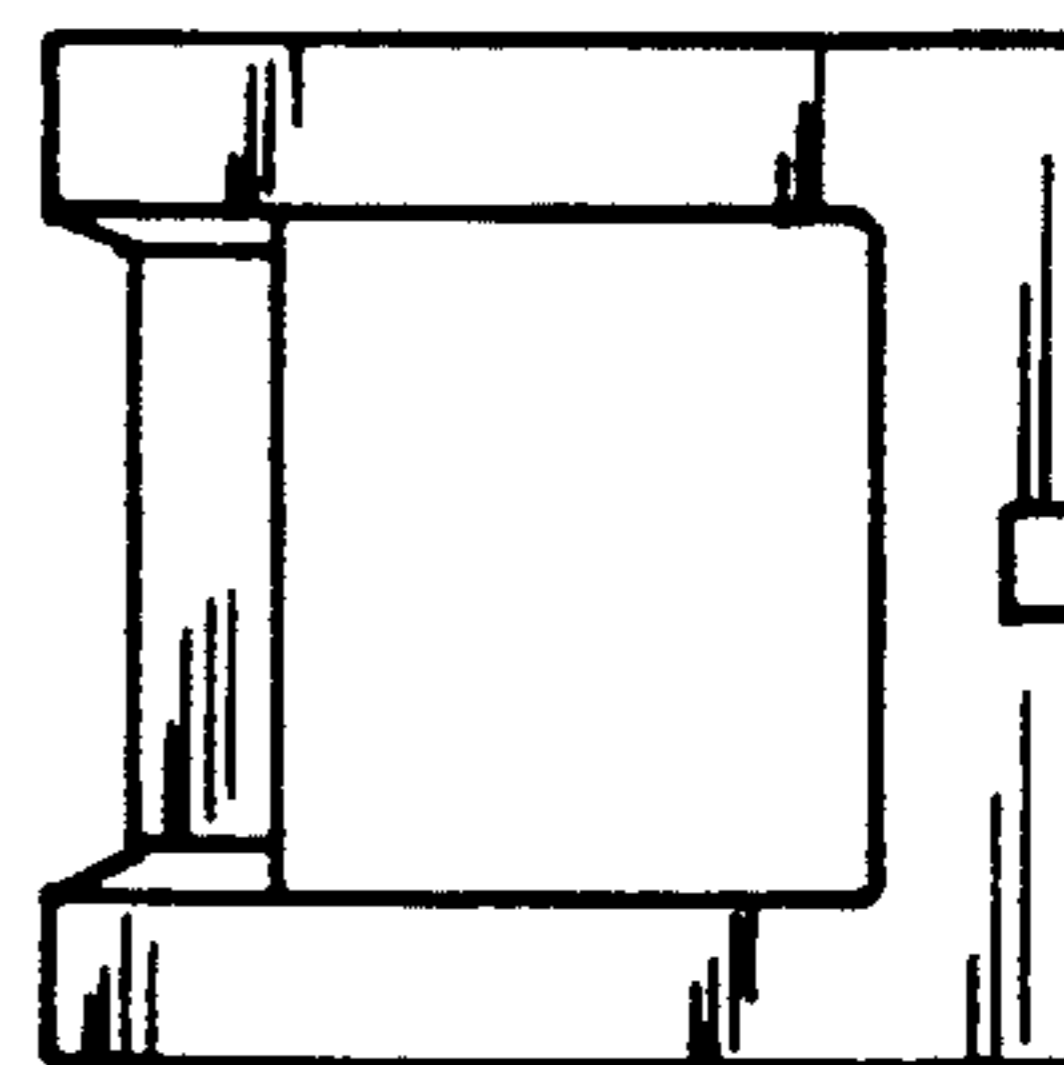

FIG-7

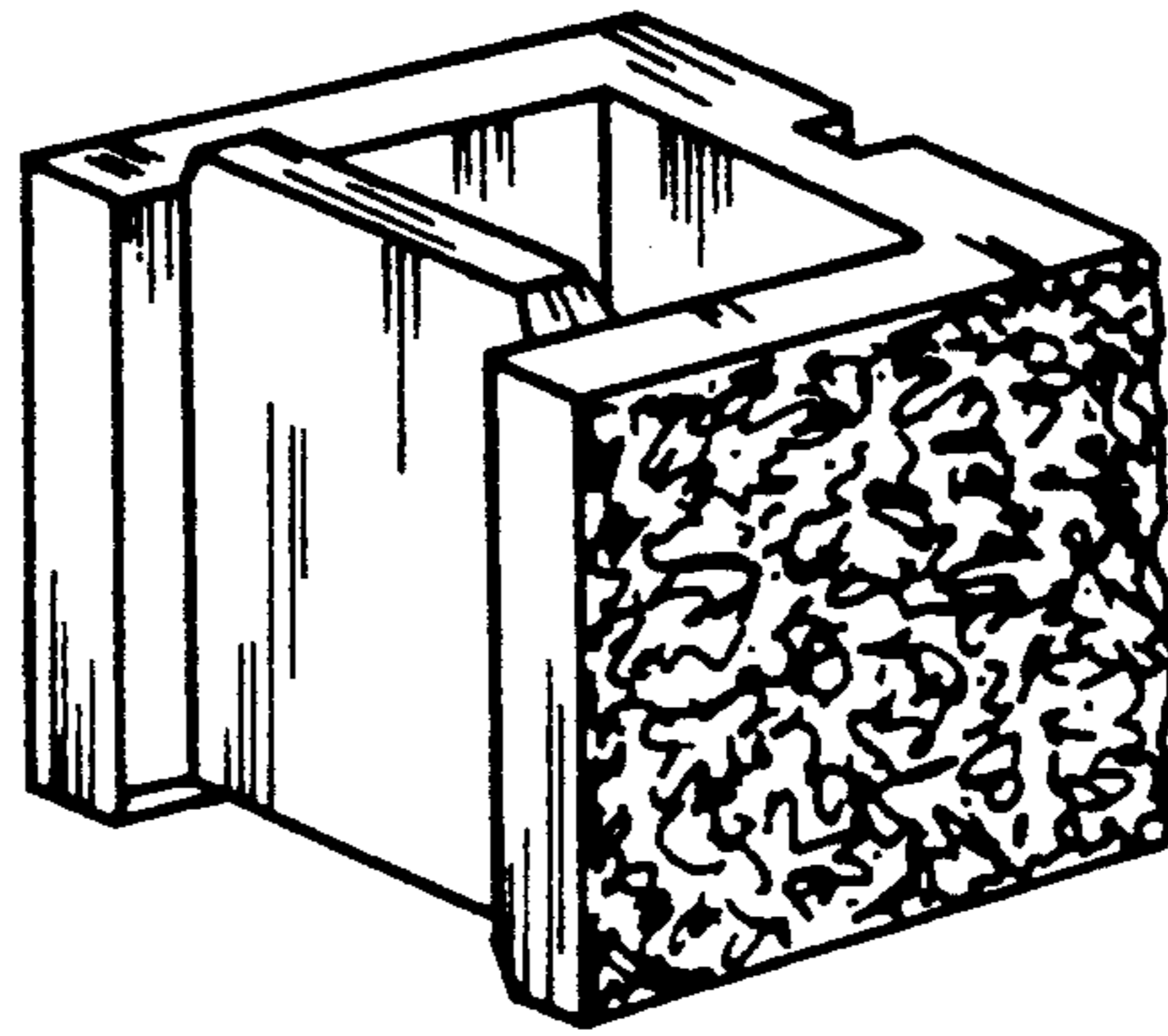

FIG-8

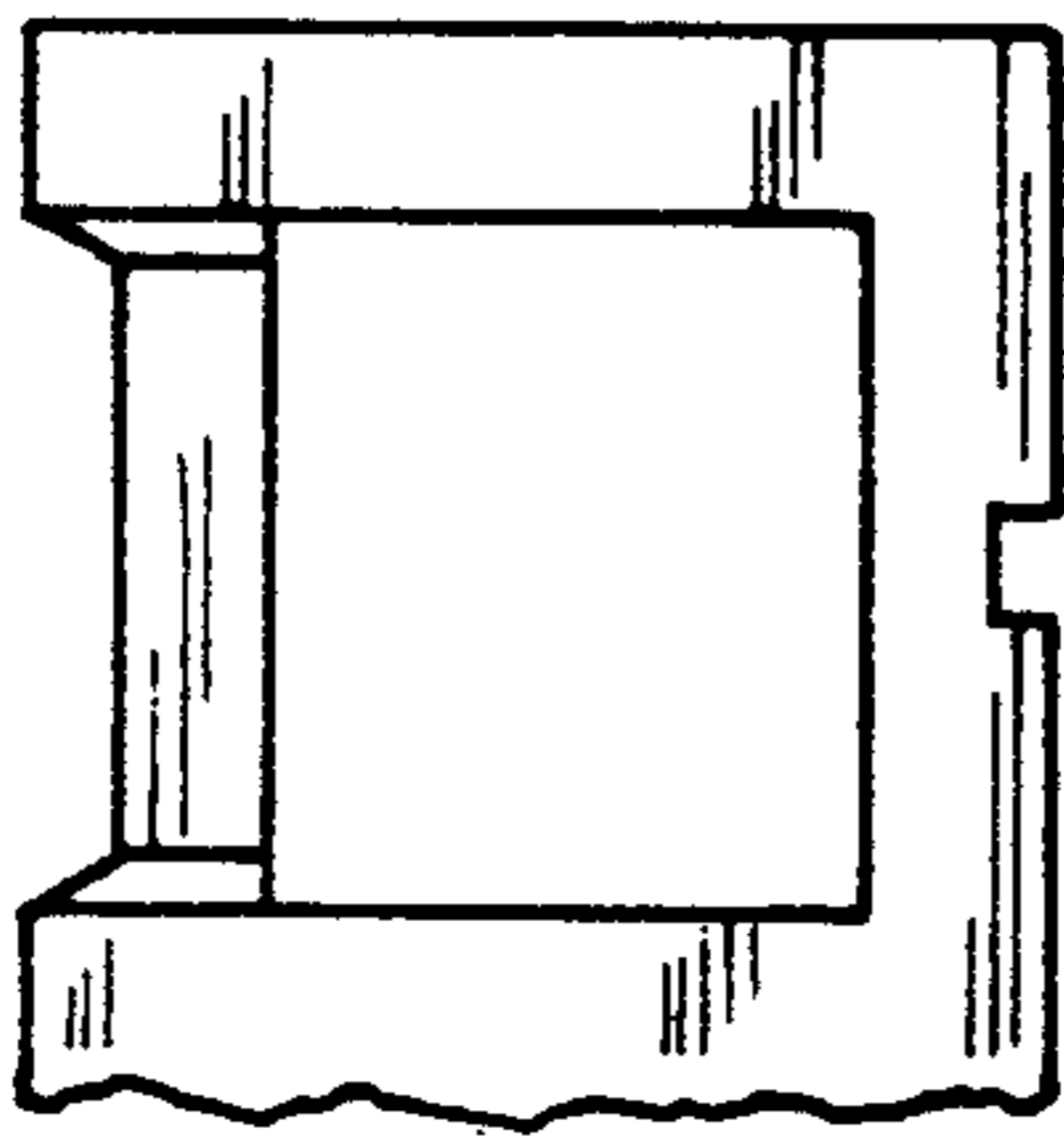

FIG-9

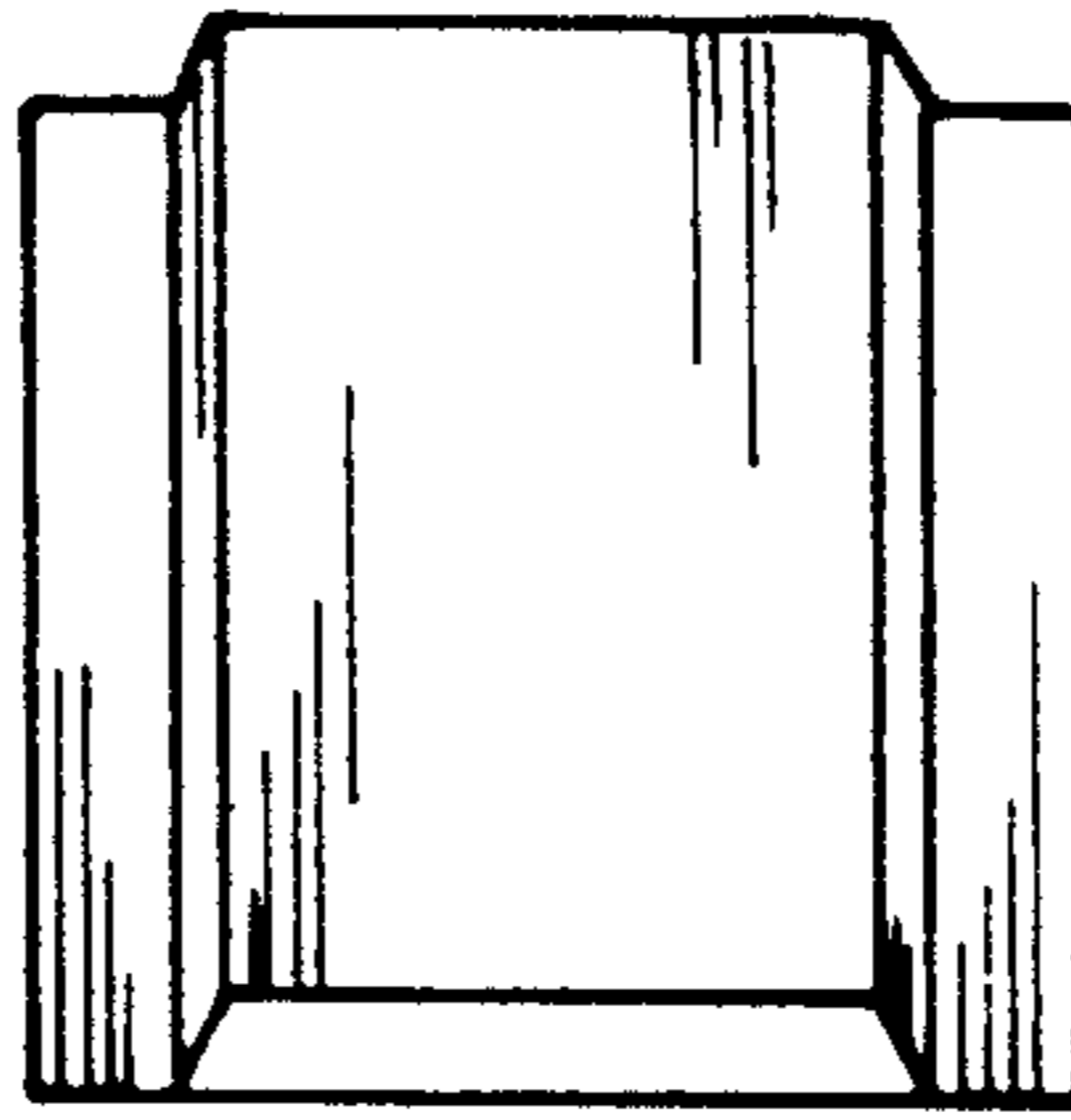

FIG-10

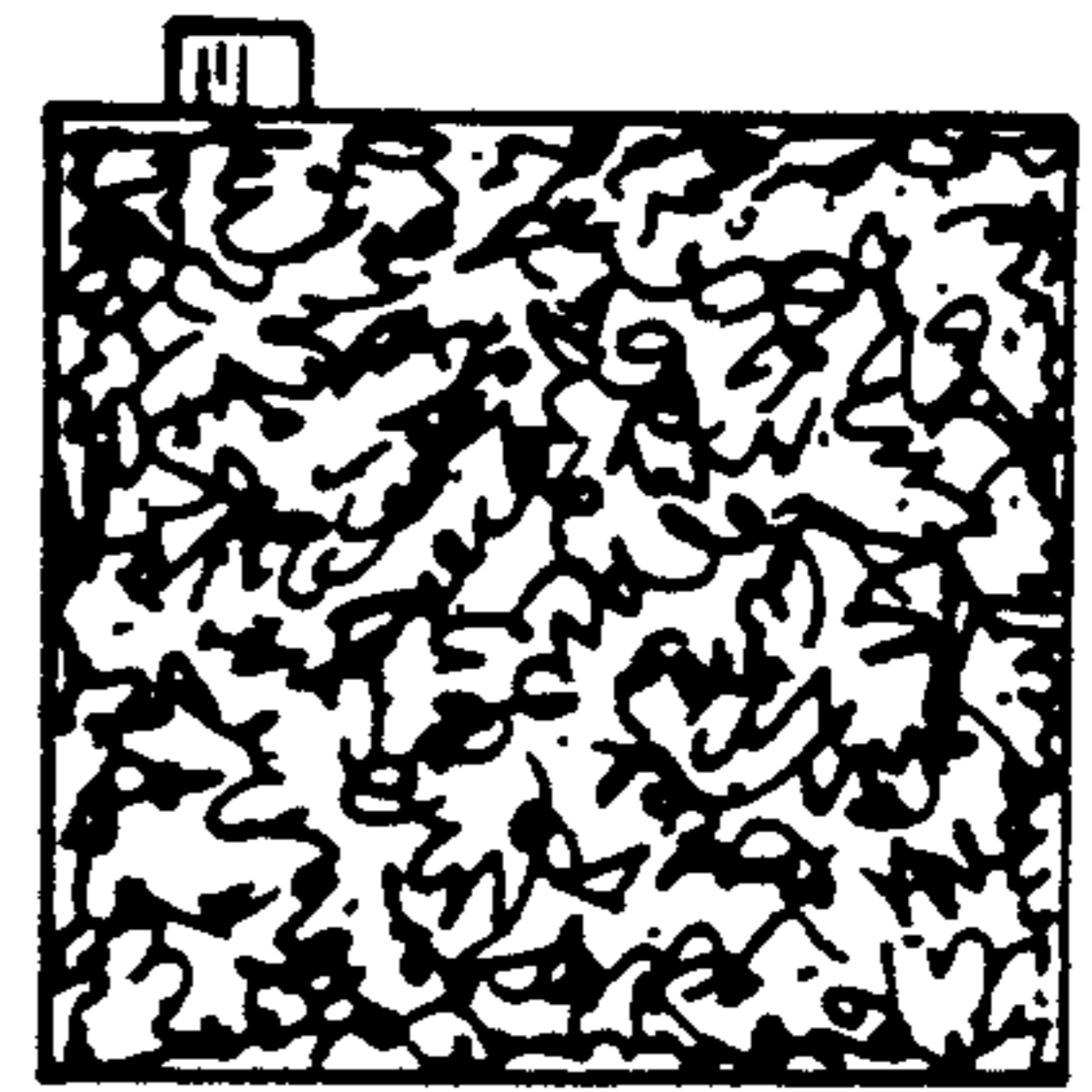

FIG-11

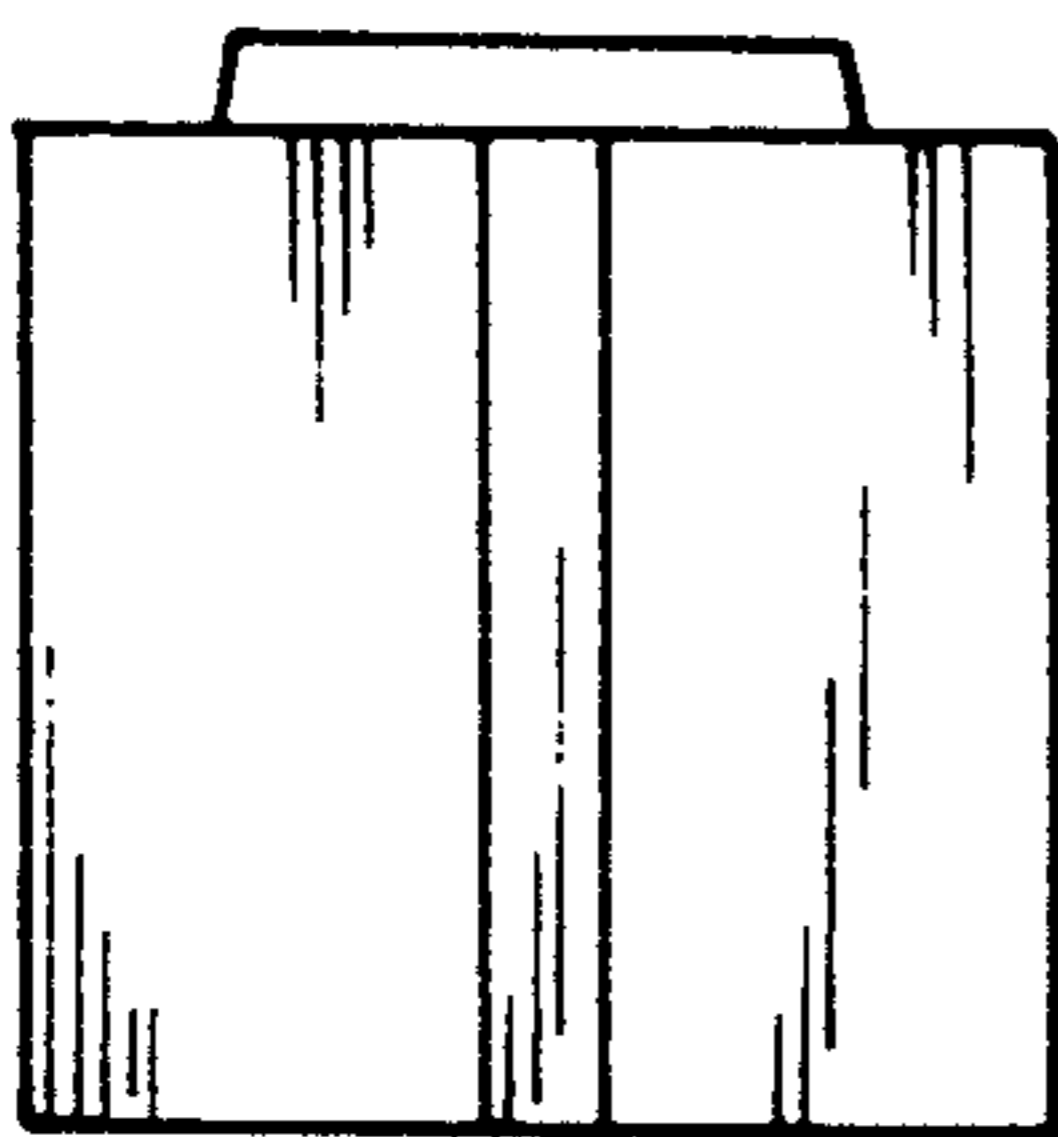

FIG-12

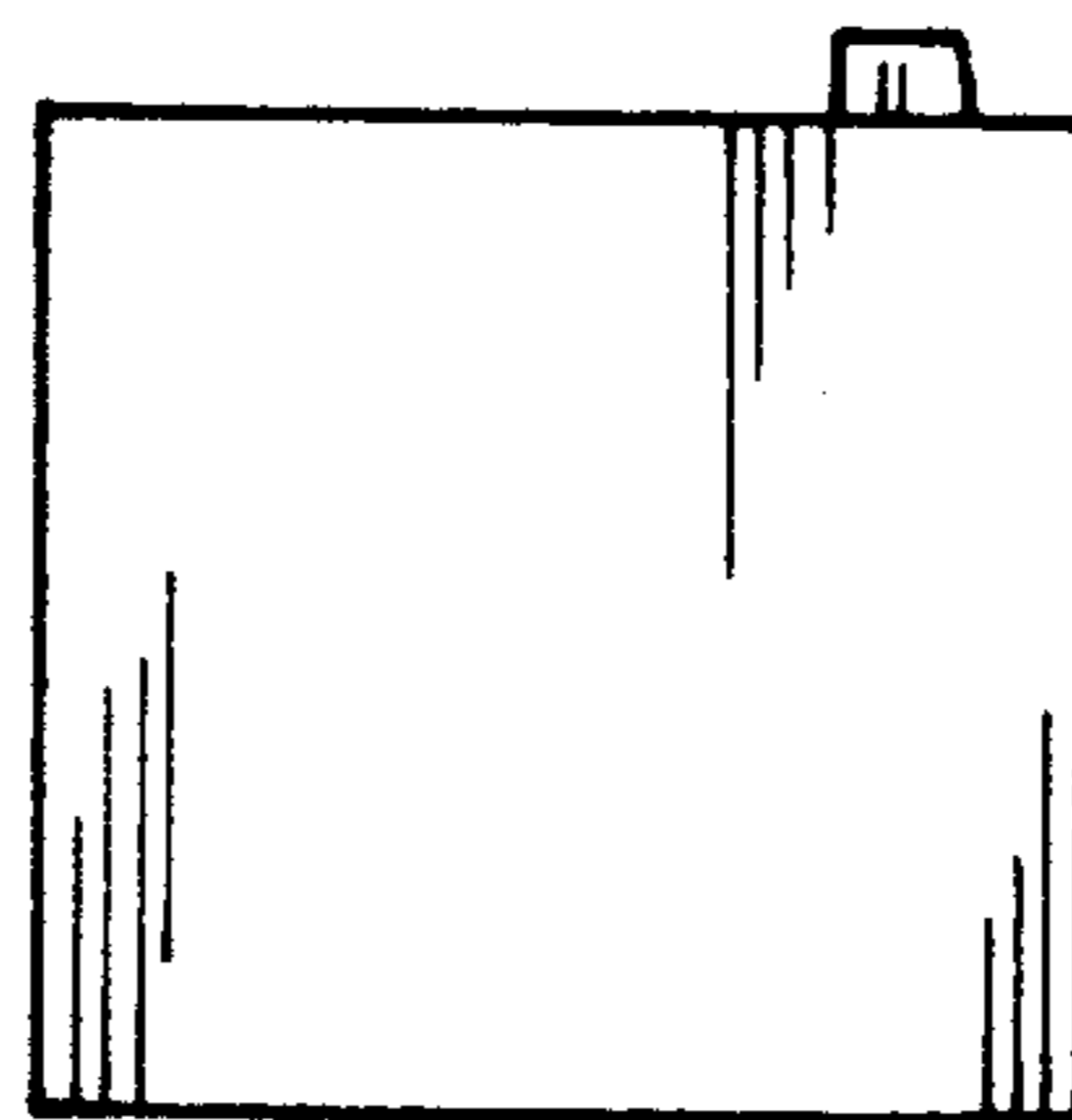

FIG-13

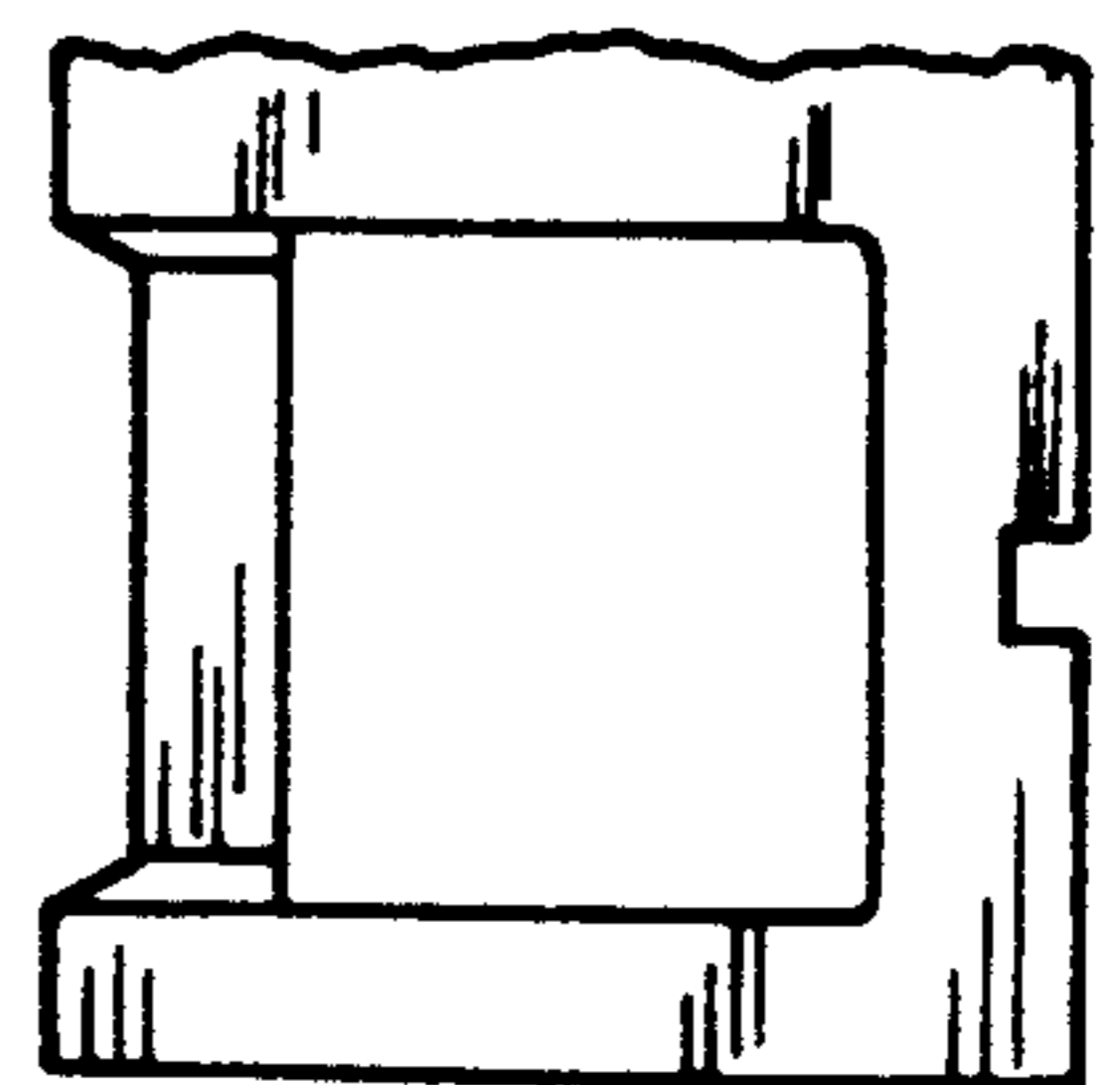

FIG-14