



US00D342568S

United States Patent [19]

[11] Patent Number: Des. 342,568

Rose

[45] Date of Patent: ** Dec. 21, 1993

[54] FILTER HOUSING

[76] Inventor: Lindsay D. Rose, 24 Waterloo Street, Heathmont, Victoria, Australia

[**] Term: 14 Years

[21] Appl. No.: 500,867

[22] Filed: Mar. 27, 1990

[52] U.S. Cl. D23/365

[58] Field of Search D23/365; 261/DIG. 15; 55/124, 126, 233

[56] References Cited

U.S. PATENT DOCUMENTS

2,021,437	11/1935	Walsh	55/233
2,268,540	1/1942	Andrews	261/DIG. 15
3,735,560	5/1973	Wellman	55/126
3,823,926	7/1974	Bracich	261/DIG. 15
4,379,712	4/1983	Sperr, Jr. et al.	55/233

Primary Examiner—Wallace R. Burke

Assistant Examiner—Lisa Lichtenstein

Attorney, Agent, or Firm—Kinney & Lange

[57] CLAIM

The ornamental design for a filter housing, as shown and described.

DESCRIPTION

FIG. 1 is a perspective view from the top, front and right side of a filter housing showing my new design; FIG. 2 is a perspective view from the top, front and left side thereof;

FIG. 3 is a front elevational view on a reduced scale thereof;

FIG. 4 is a top plan view on a reduced scale thereof;

FIG. 5 is a bottom plan view on a reduced scale thereof;

FIG. 6 is a side elevational view on a reduced scale from the left side thereof; and

FIG. 7 is a side elevational view on a reduced scale from the right side thereof.

The rear view thereof is devoid of ornamentation and forms no part of the claimed design.

The pattern of holes partially shown in FIGS. 1 and 2, is understood to extend throughout the panel.

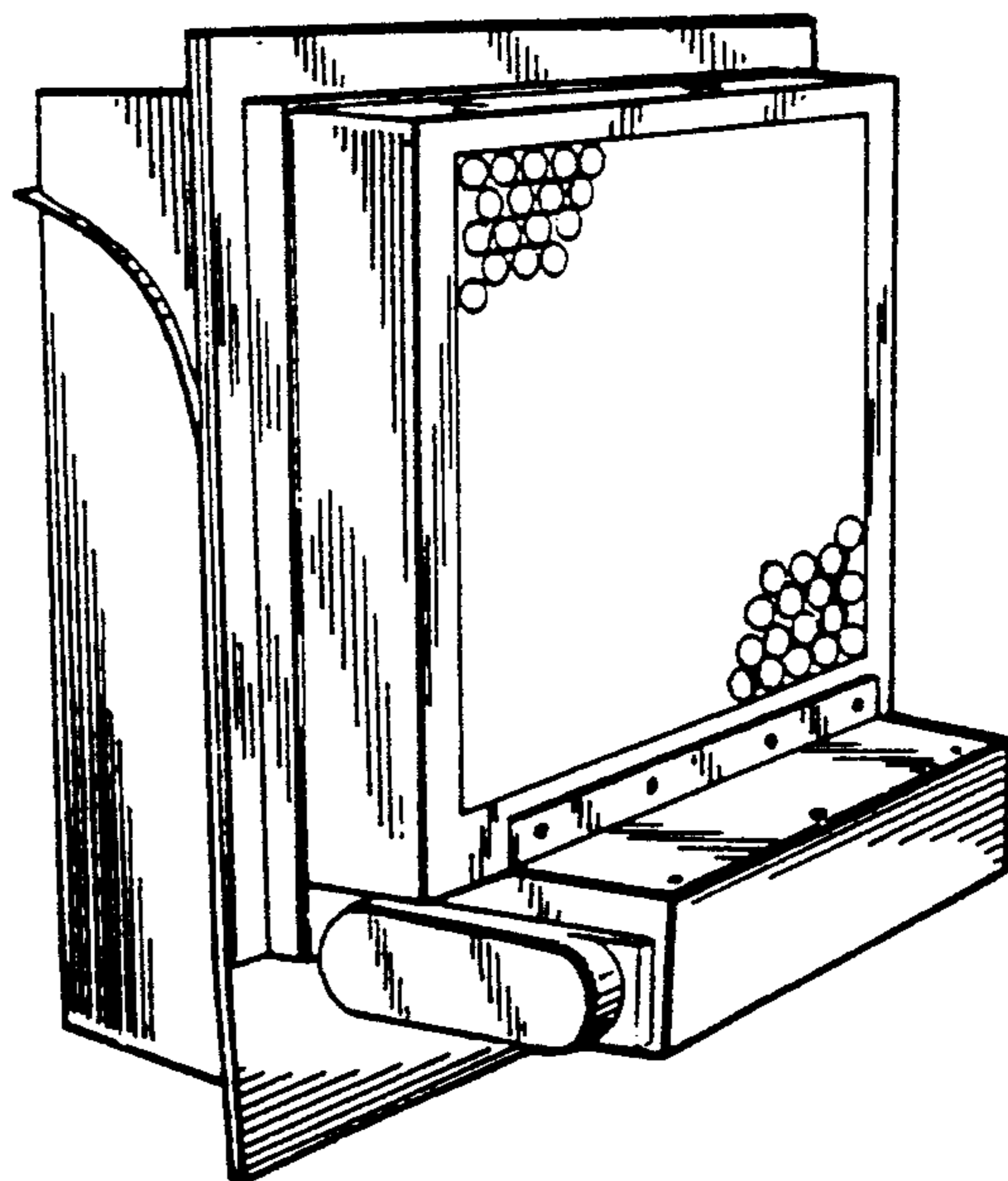
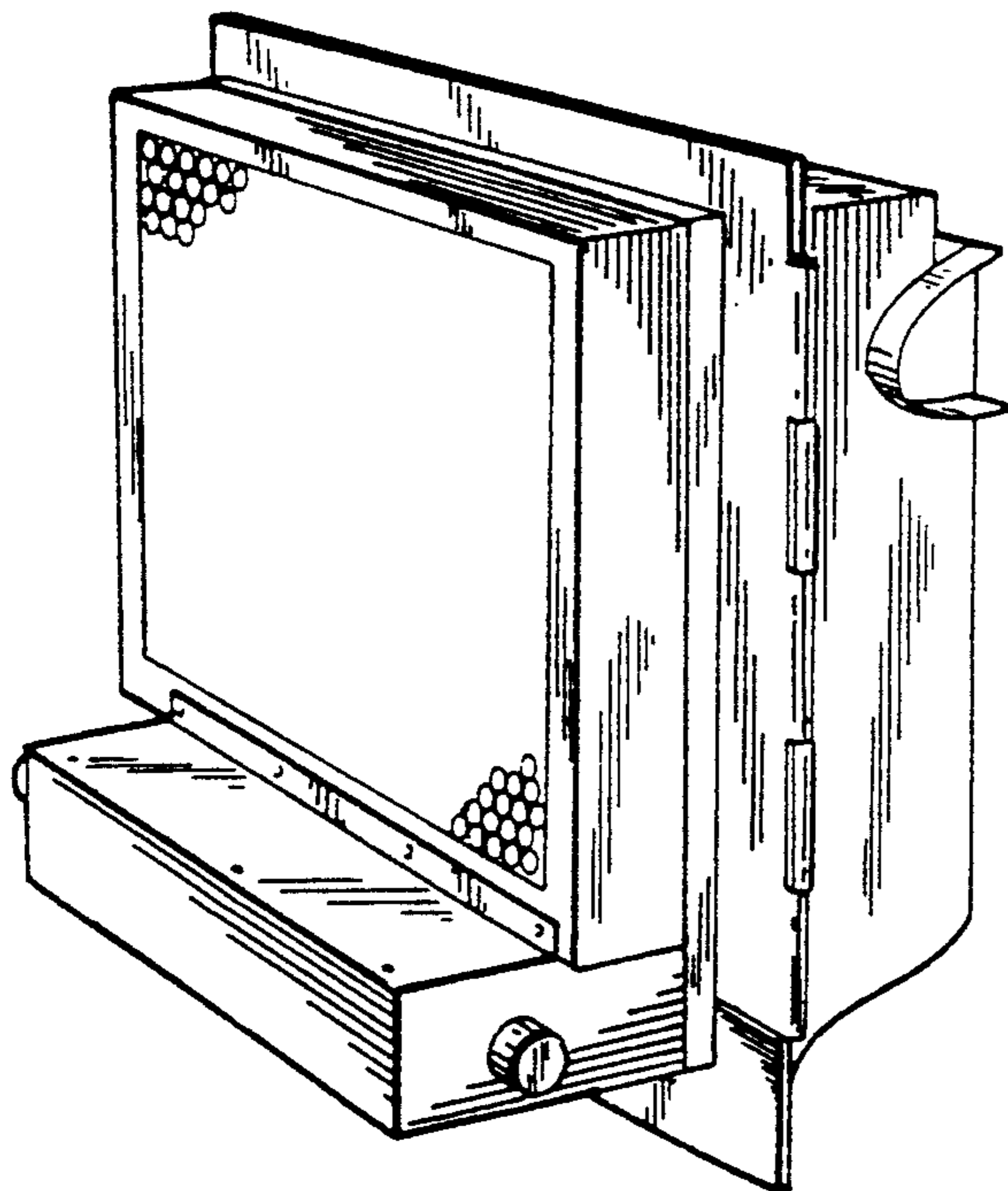

Fig. 1.

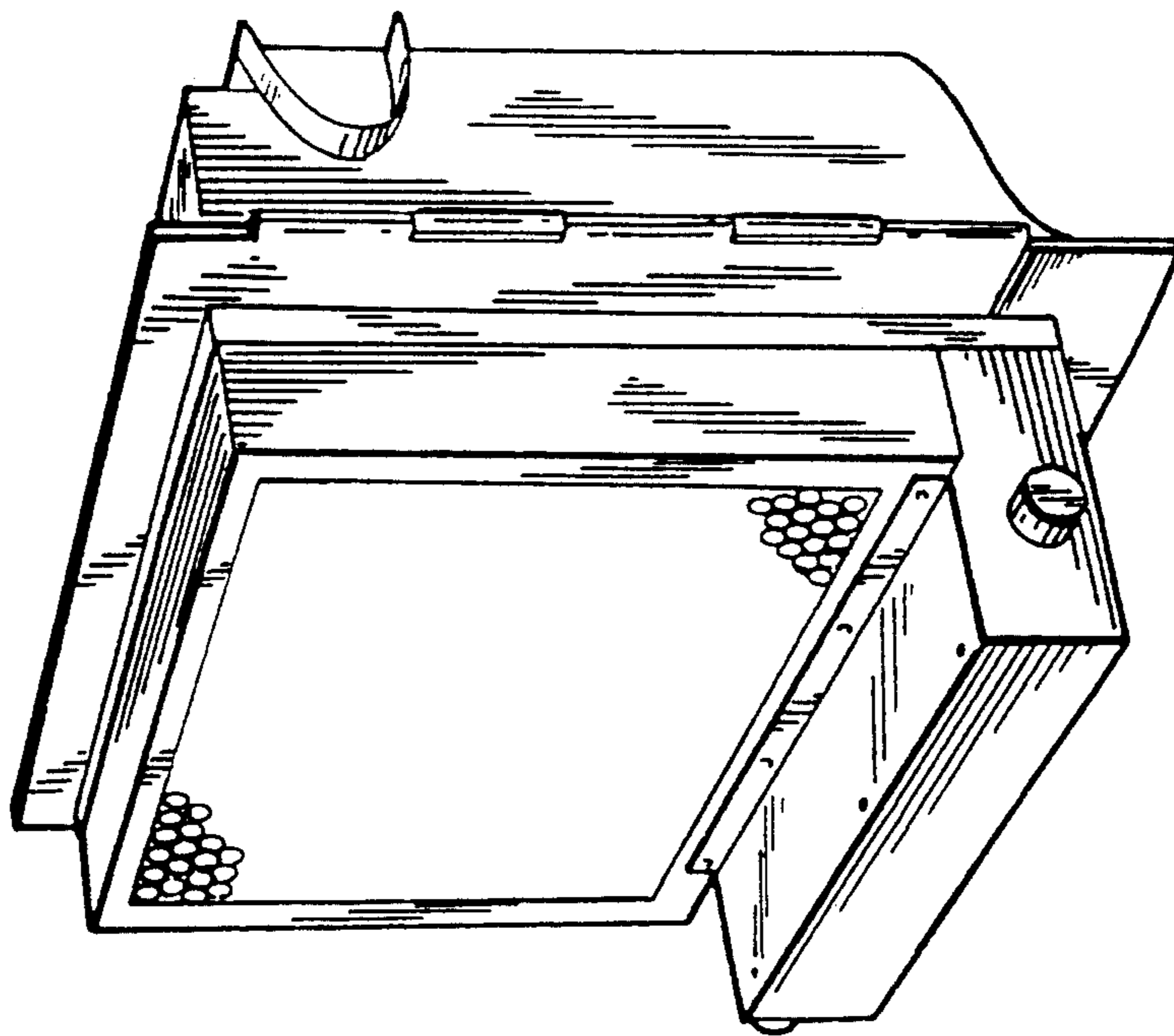
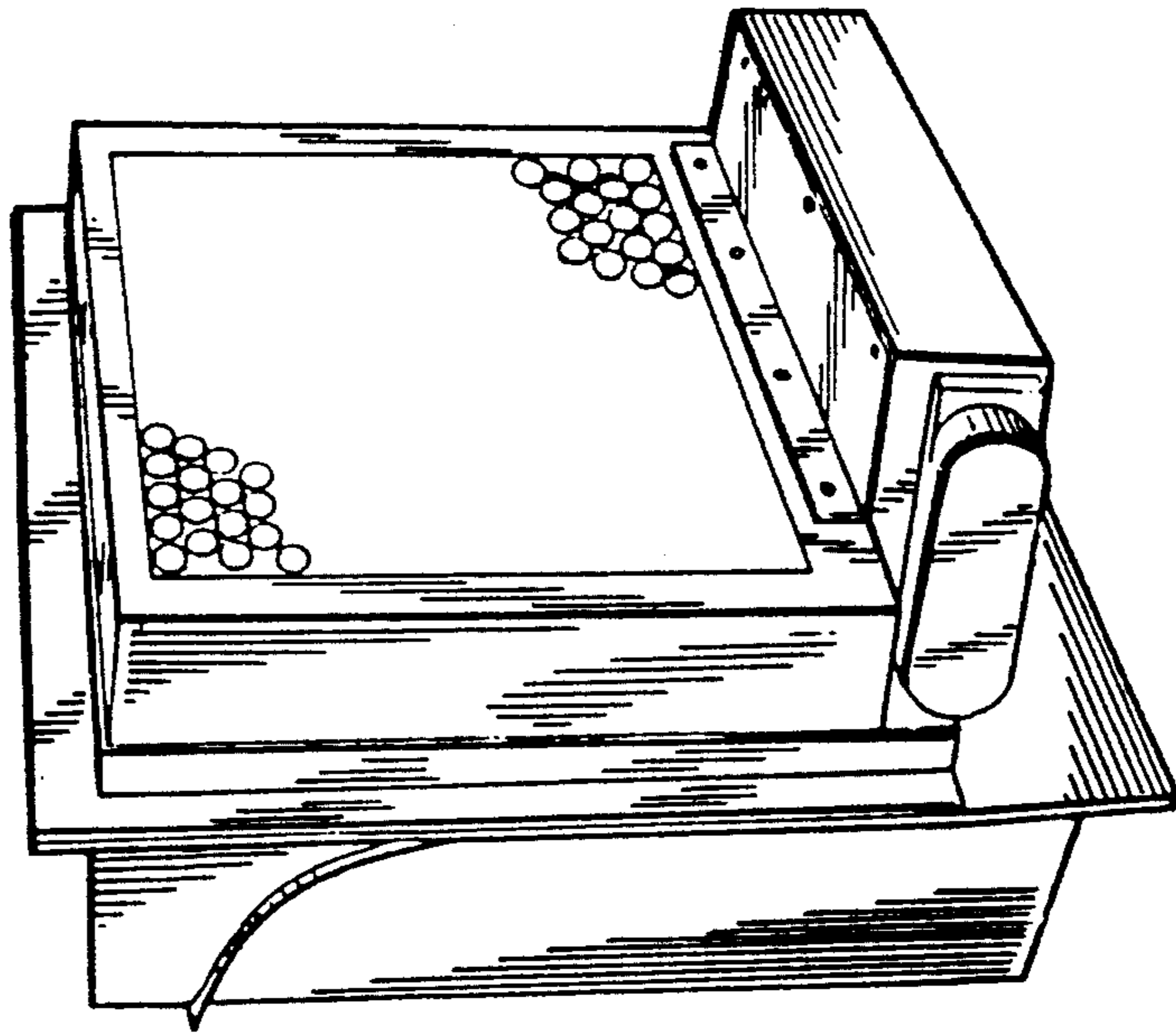

Fig. 2.



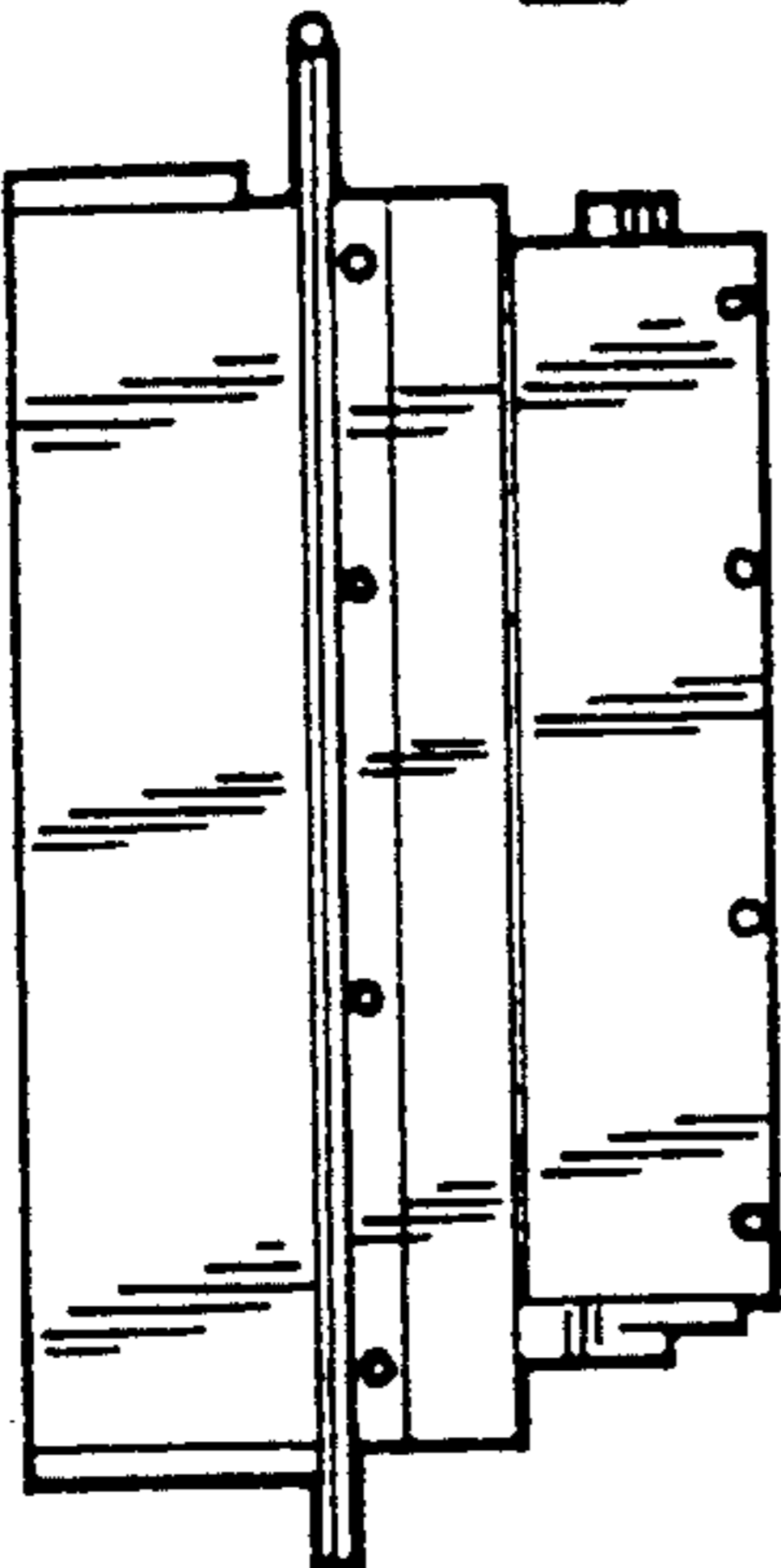

Fig. 4



Fig. 6

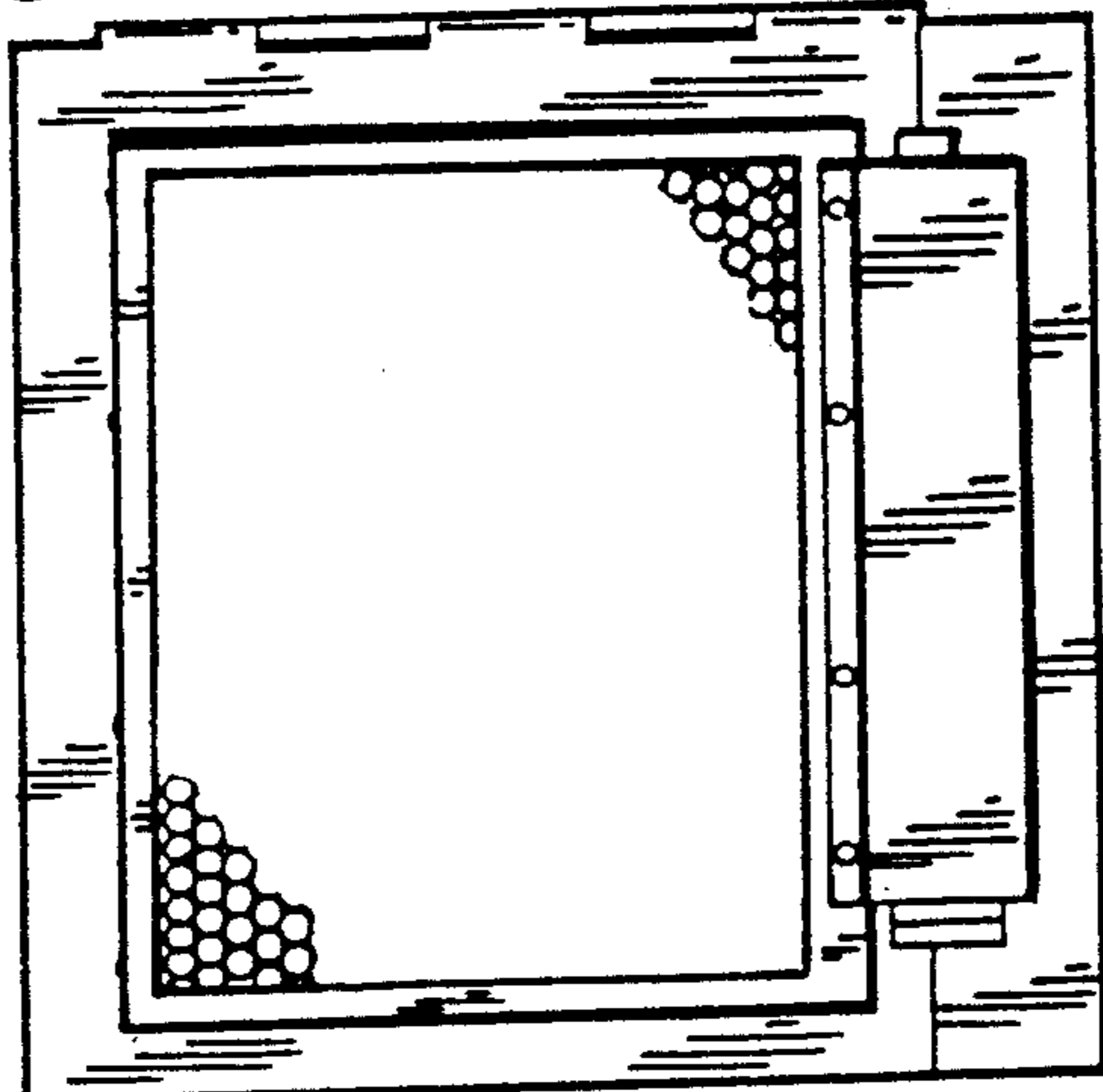

Fig. 3

Fig. 7

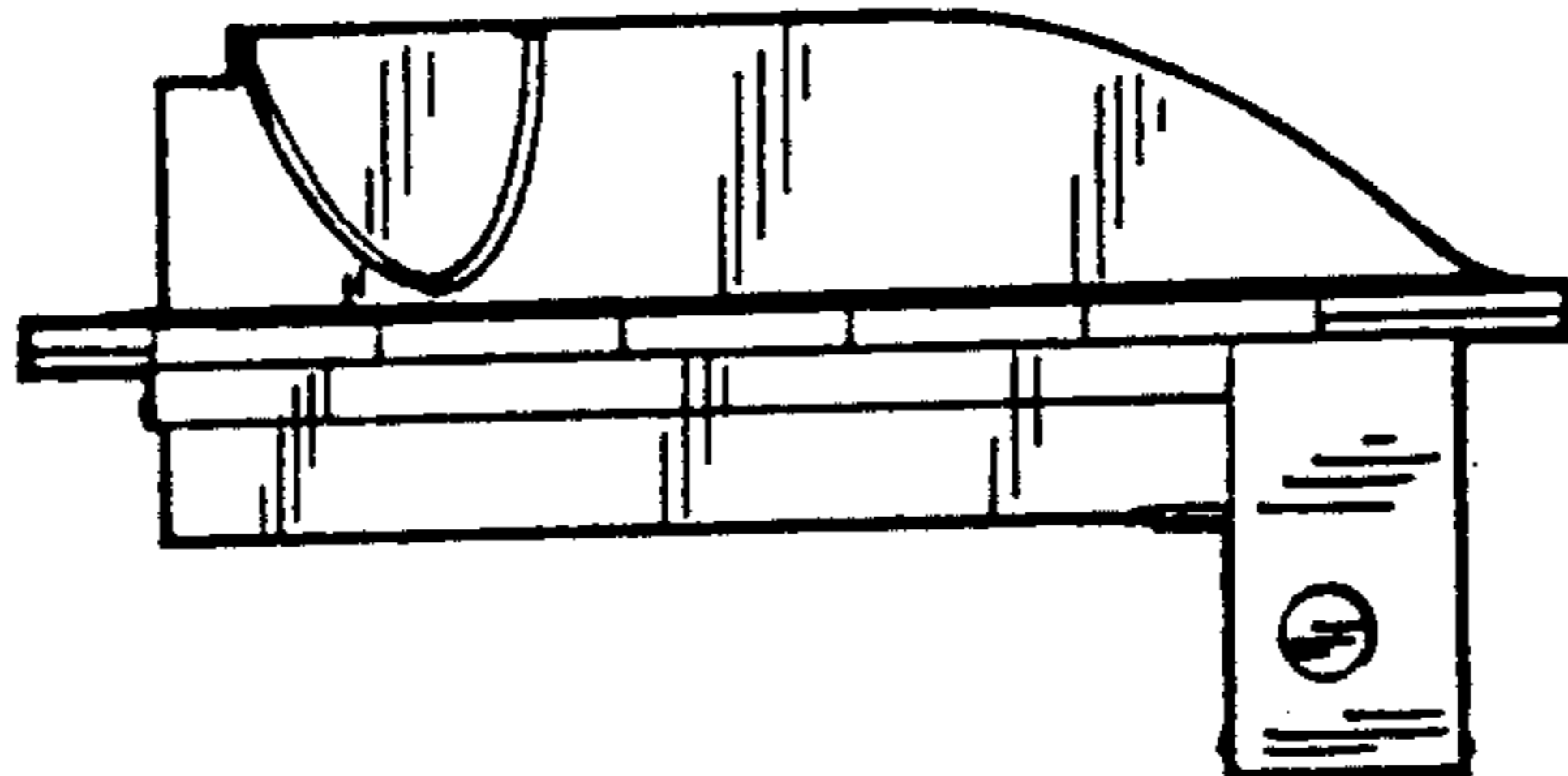

Fig. 5

