



US00D342558S

United States Patent [19]

[11] Patent Number: **Des. 342,558**

Diesterheft

[45] Date of Patent: **** Dec. 21, 1993**

[54] GOLF PUTTER HEAD

[76] Inventor: **Richard W. Diesterheft**, 995 Wildwood, Northbrook, Ill. 60062

[**] Term: **14 Years**

[21] Appl. No.: **5,781**

[22] Filed: **Mar. 12, 1993**

[52] U.S. Cl. **D21/219**

[58] Field of Search **D21/214-220;**
273/164.1, 167-175

[56] References Cited

U.S. PATENT DOCUMENTS

- | | | | | |
|------------|--------|-----------|-------|---------|
| D. 213,118 | 1/1969 | Onaka | | D21/219 |
| D. 318,089 | 7/1991 | Antonious | | D21/219 |

OTHER PUBLICATIONS

Golf Digest, Jun. 1976, p. 30, upper left, golf club head.

Primary Examiner—Melvin B. Feifer

Attorney, Agent, or Firm—Juettner Pyle & Lloyd

[57] CLAIM

The ornamental design for golf putter head, as shown and described.

DESCRIPTION

FIG. 1 is a perspective view of the golf putter head showing my new design;

FIG. 2 is a right side view thereof;

FIG. 3 is a left side view thereof;

FIG. 4 is a bottom view thereof;

FIG. 5 is a front inverted view thereof;

FIG. 6 is a top plan view thereof; and,

FIG. 7 is a back inverted view thereof.

The broken line showing of a shaft segment is for illustrative purposes only.

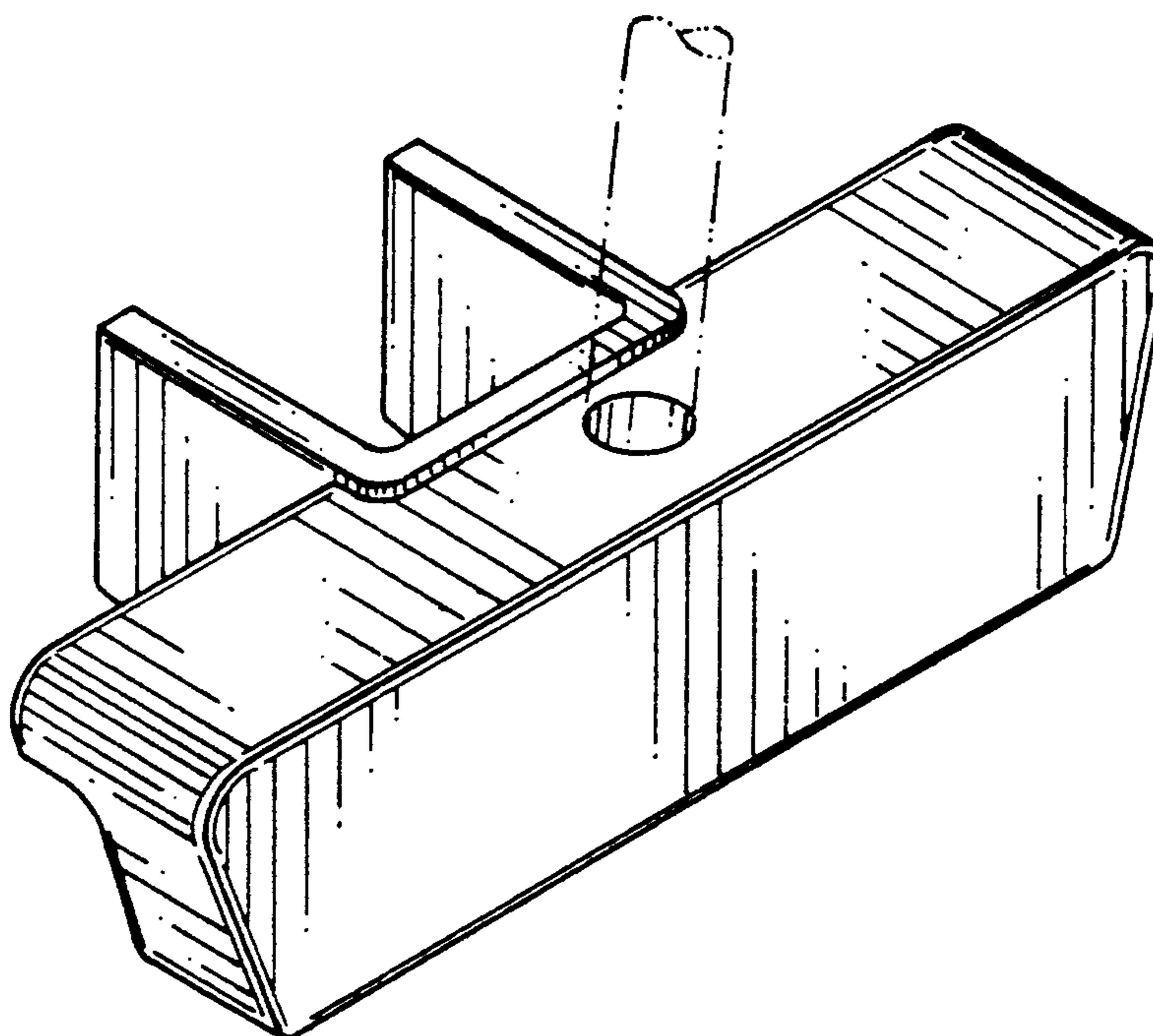

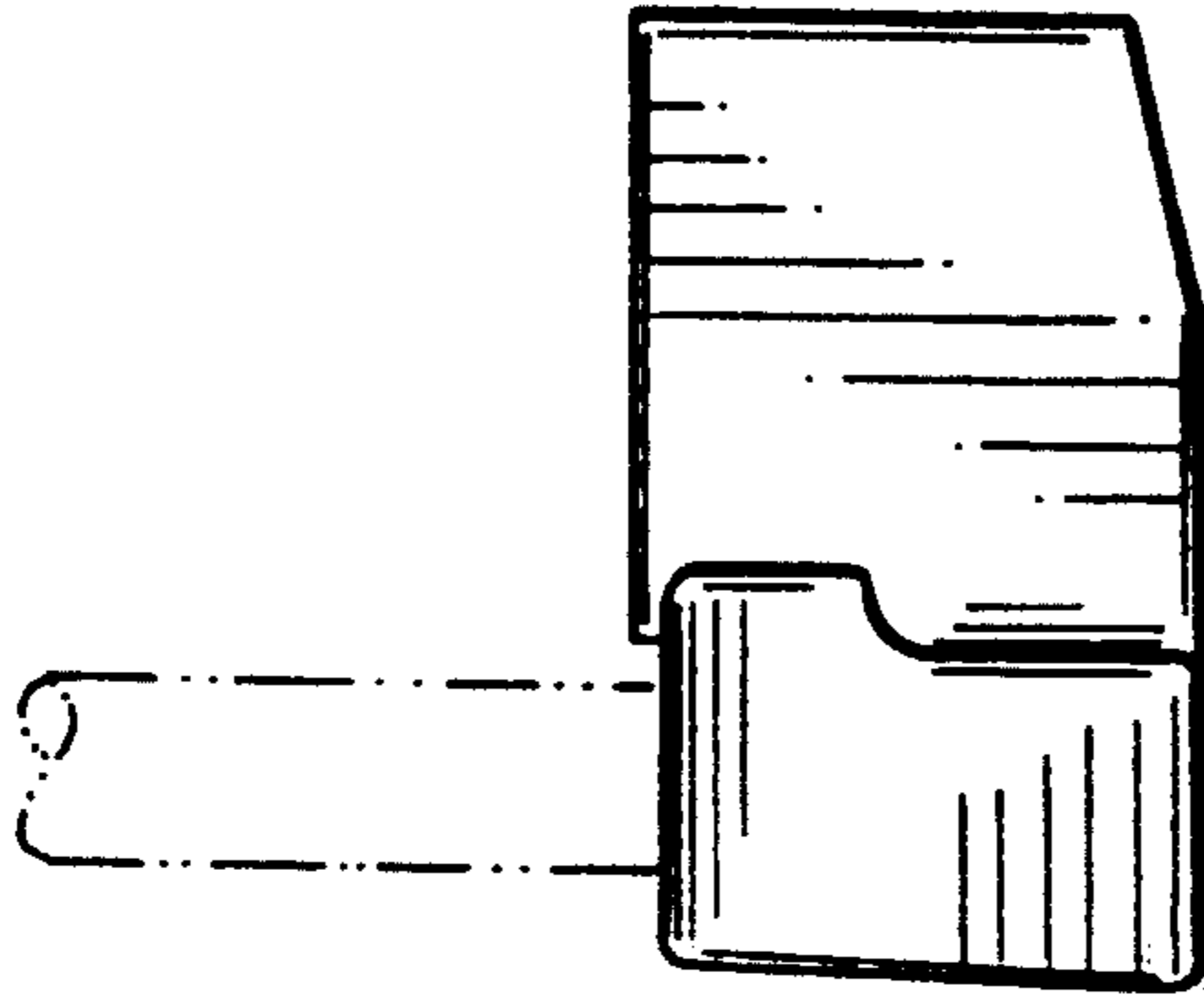

Fig. 3

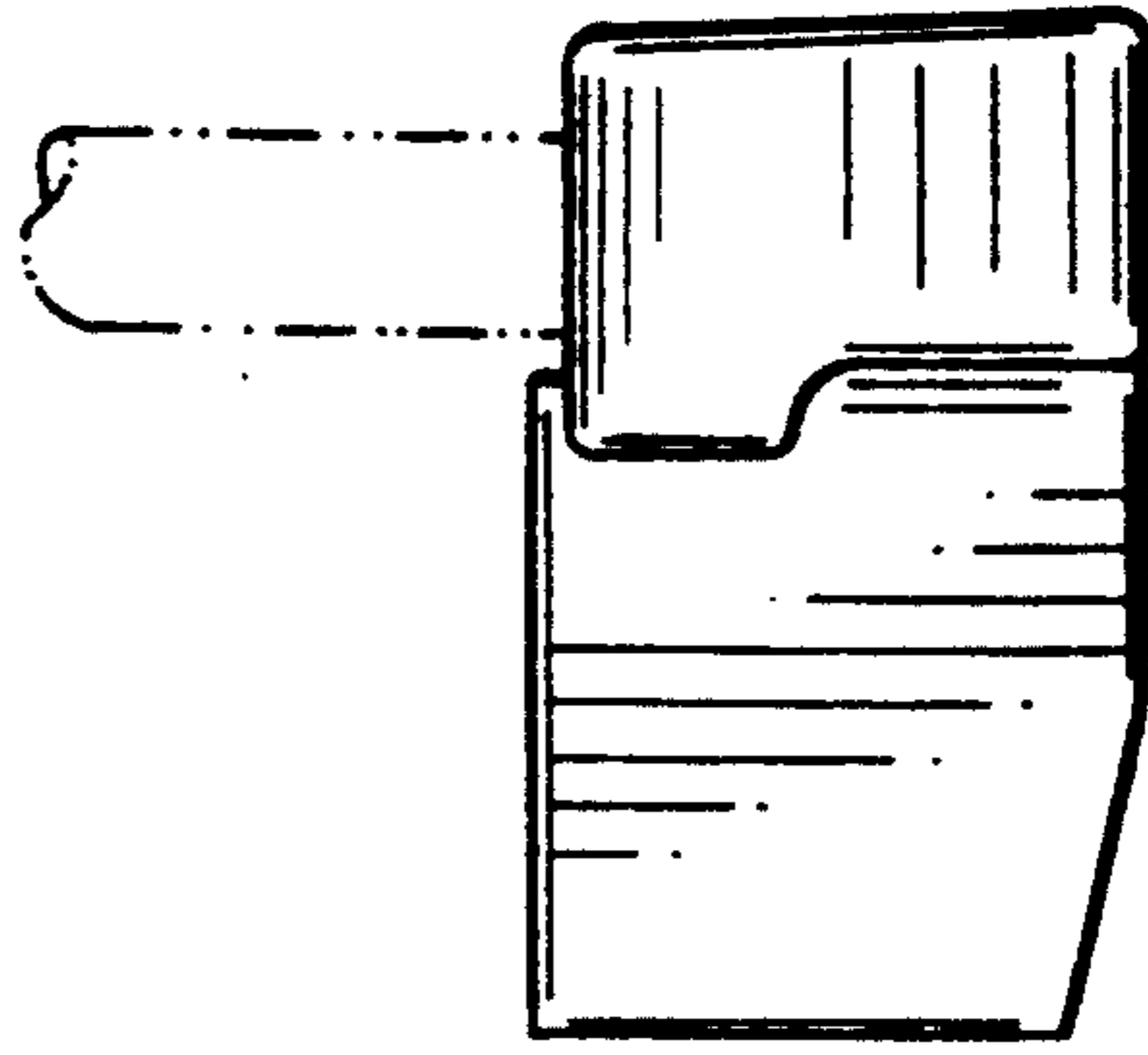

Fig. 2

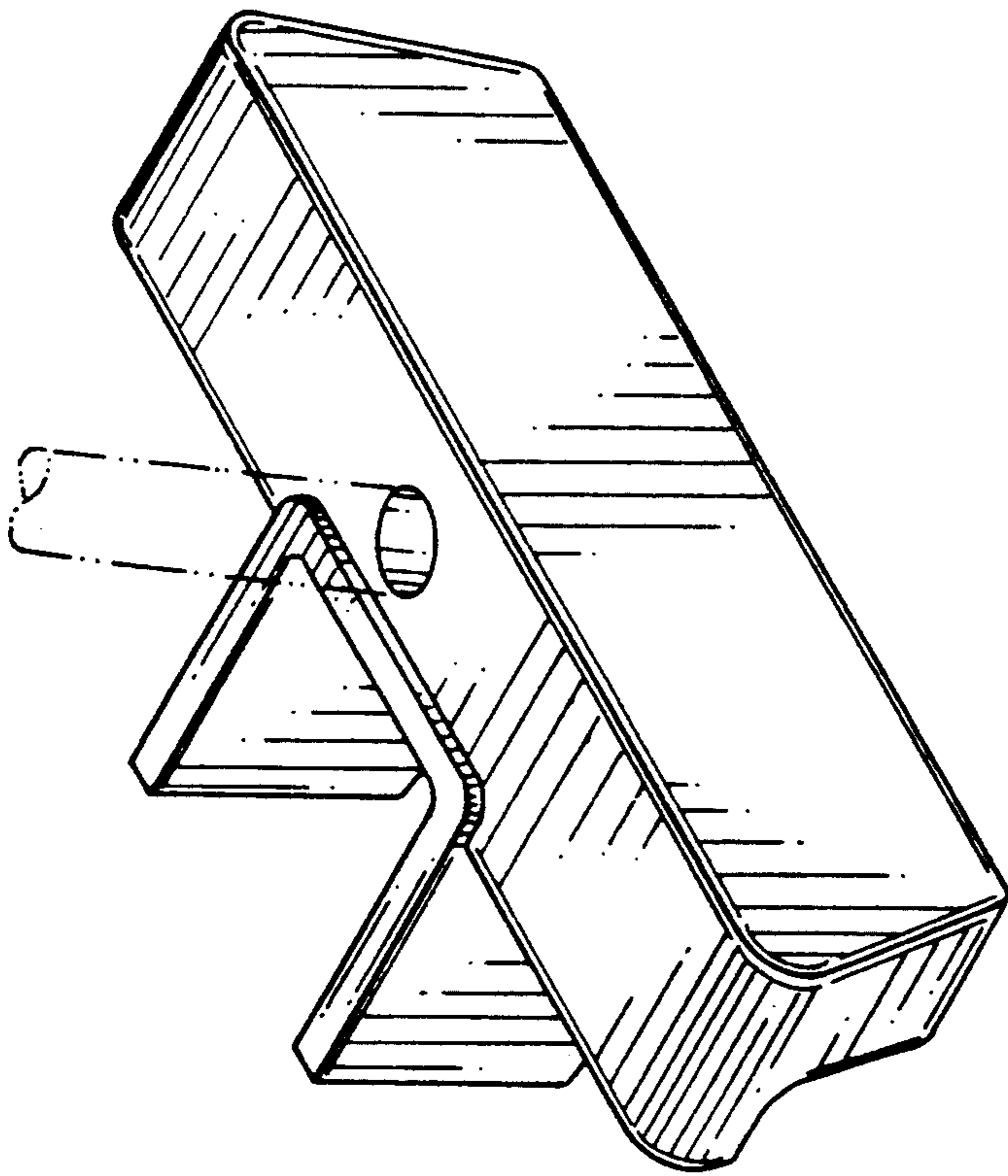

Fig. 1

Fig. 4

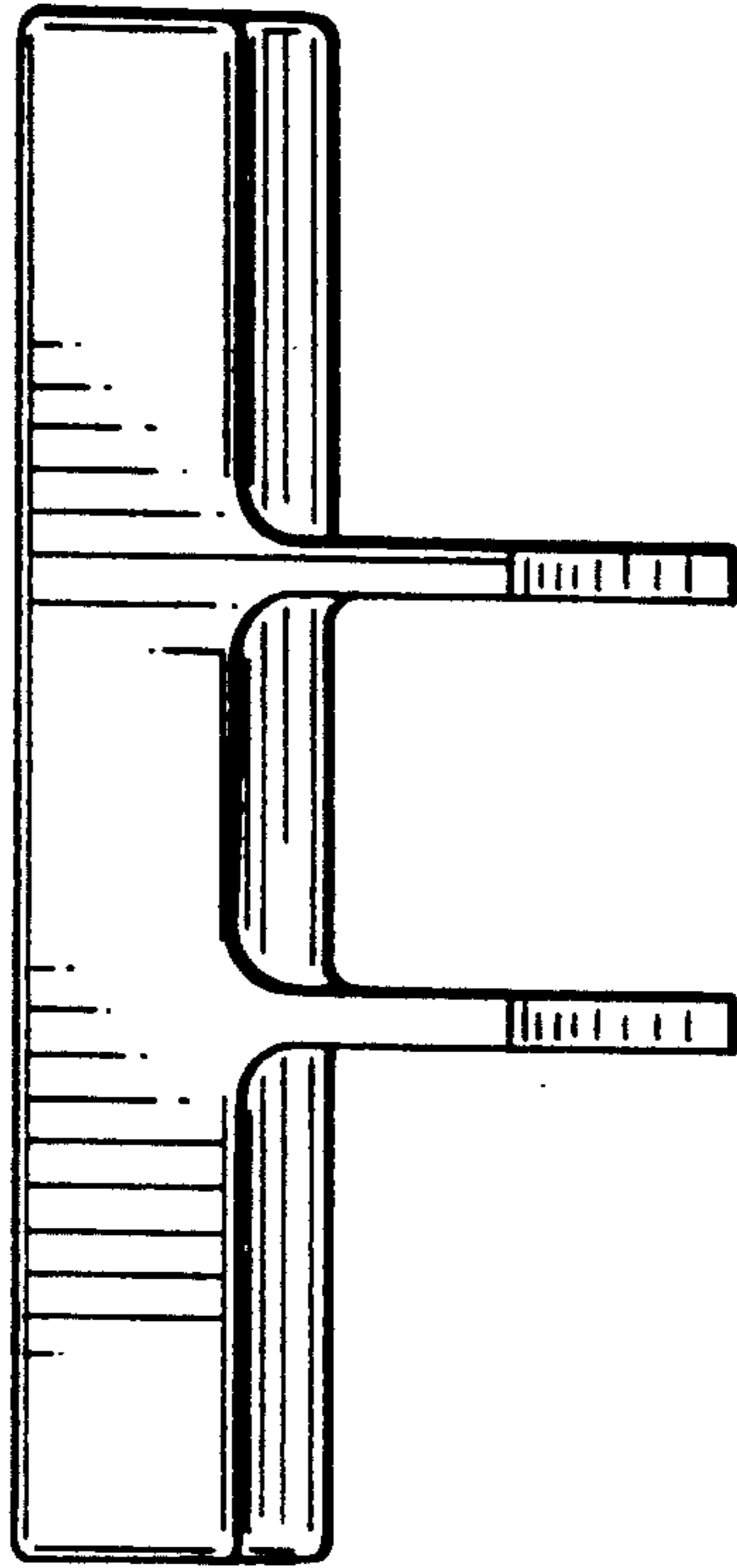

Fig. 7

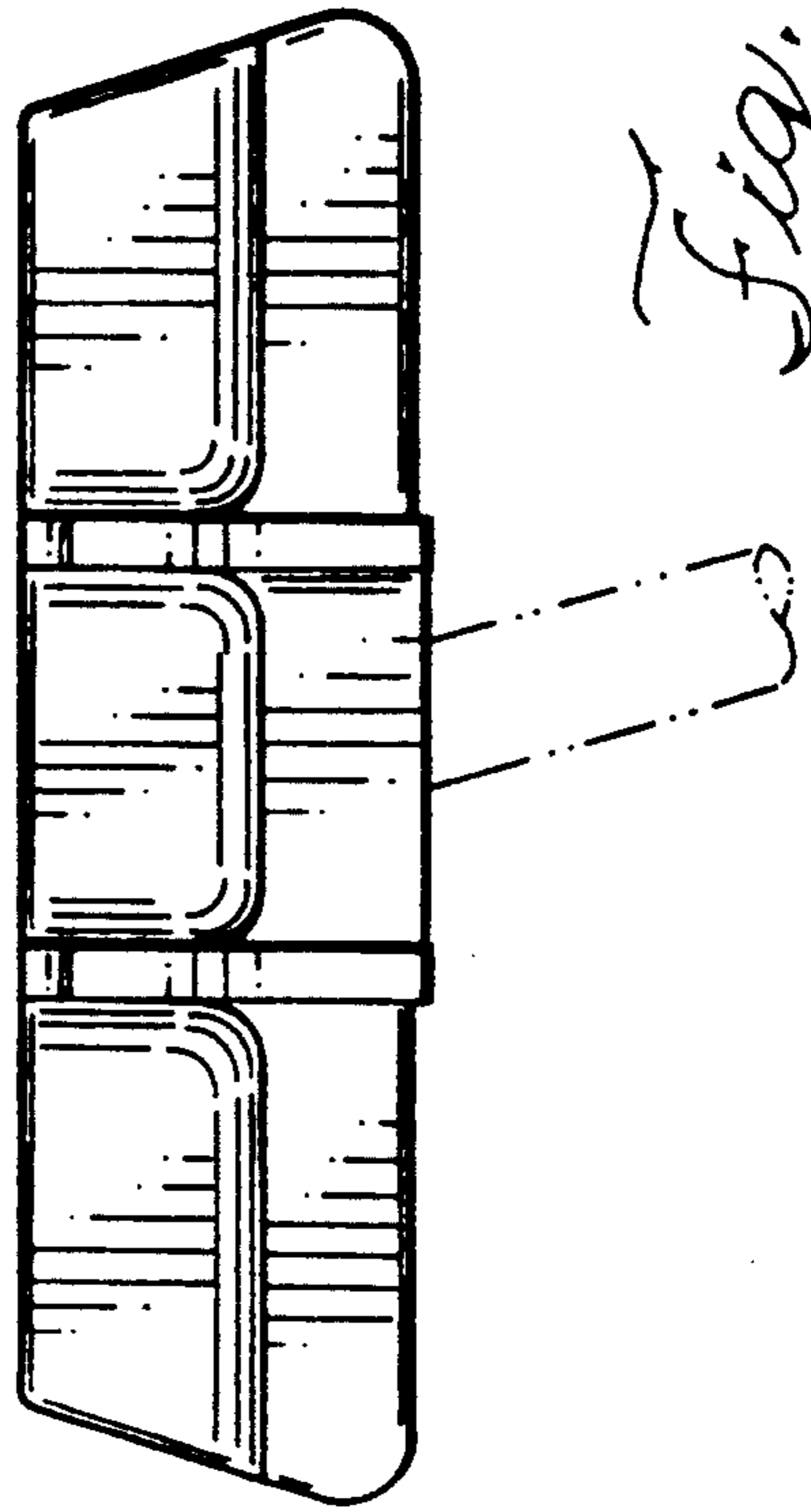

Fig. 5

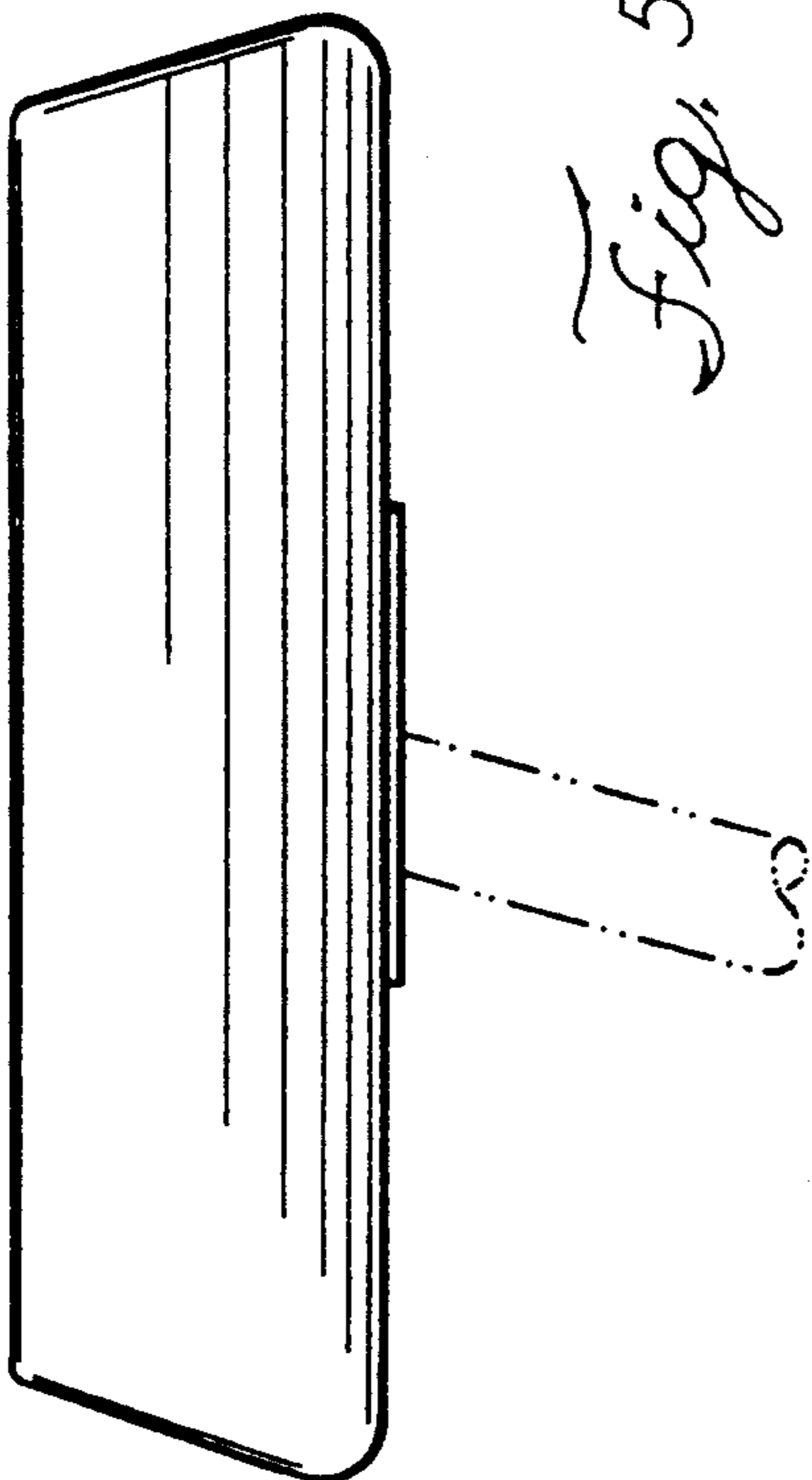

Fig. 6

