



US00D342557S

United States Patent [19]

[11] Patent Number: **Des. 342,557**

Frick

[45] Date of Patent: **** Dec. 21, 1993**

[54] **STUFFED DOLL**

[76] Inventor: **Janet Frick, Rt. 2, Box 334, Bay City, Tex. 77414**

[**] Term: **14 Years**

[21] Appl. No.: **812,975**

[22] Filed: **Dec. 19, 1991**

[52] U.S. Cl. **D21/166**

[58] Field of Search **D21/166, 155, 171, 173, D21/174, 177; 446/268; D11/160**

[56] **References Cited**

U.S. PATENT DOCUMENTS

- D. 142,747 10/1945 Stevens D21/171
- D. 271,405 11/1983 Helein D21/166
- D. 280,754 9/1985 Zacherle et al. D21/166
- D. 292,302 10/1987 Hale D21/166 X

- D. 304,478 11/1989 Fiust D21/166 X
- D. 304,479 11/1989 Fiust D21/171

Primary Examiner—Melvin B. Feifer
Assistant Examiner—Lucy Lieberman
Attorney, Agent, or Firm—Bernard Reiter

[57] **CLAIM**

The ornamental design for a stuffed doll, as shown and described.

DESCRIPTION

FIG. 1 is a front elevation of a stuffed doll showing my new design;
FIG. 2 is a right side elevation thereof;
FIG. 3 is a top plan view thereof;
FIG. 4 is a left side elevation thereof;
FIG. 5 is a rear elevation thereof; and,
FIG. 6 is a bottom plan view thereof.

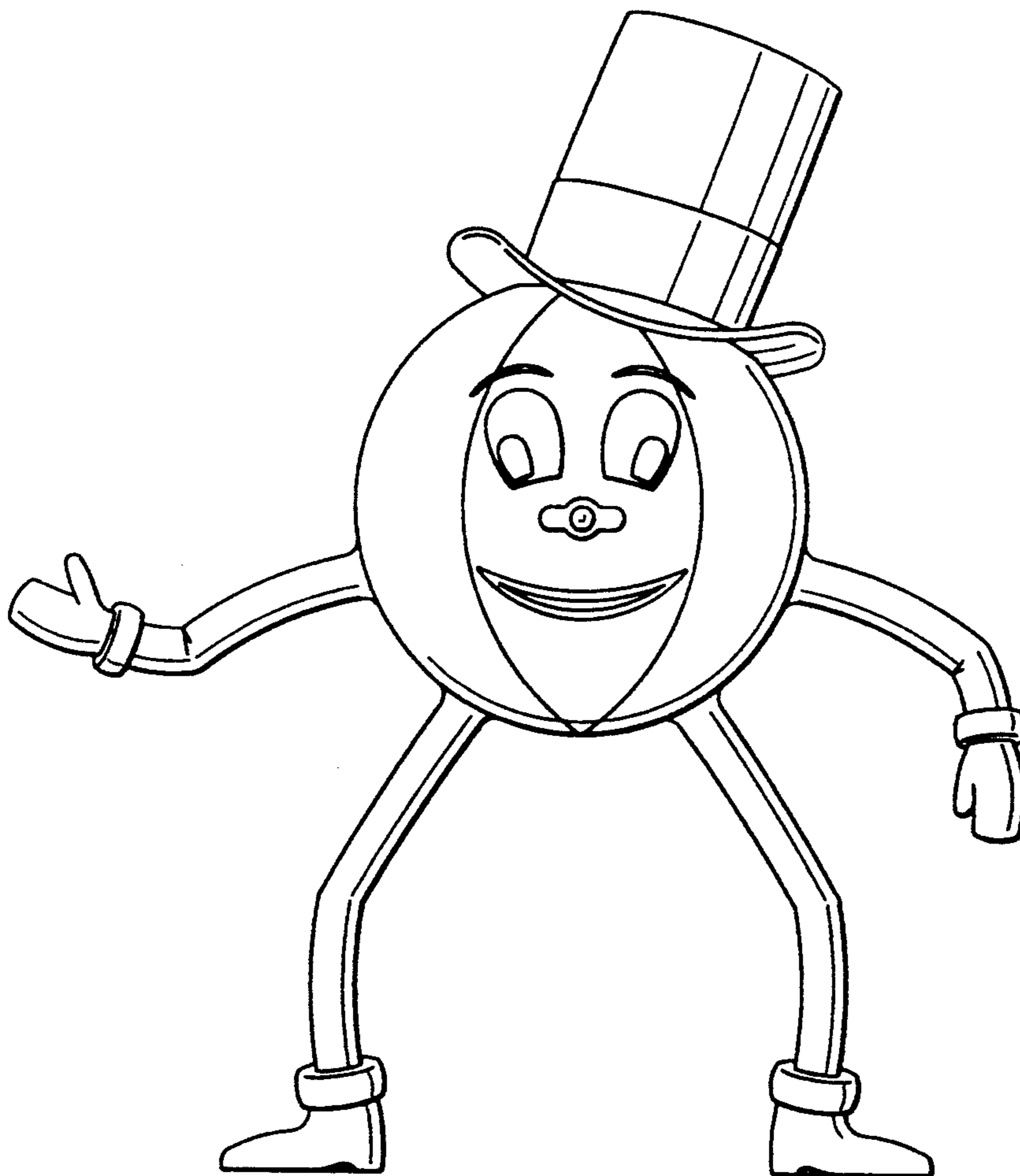

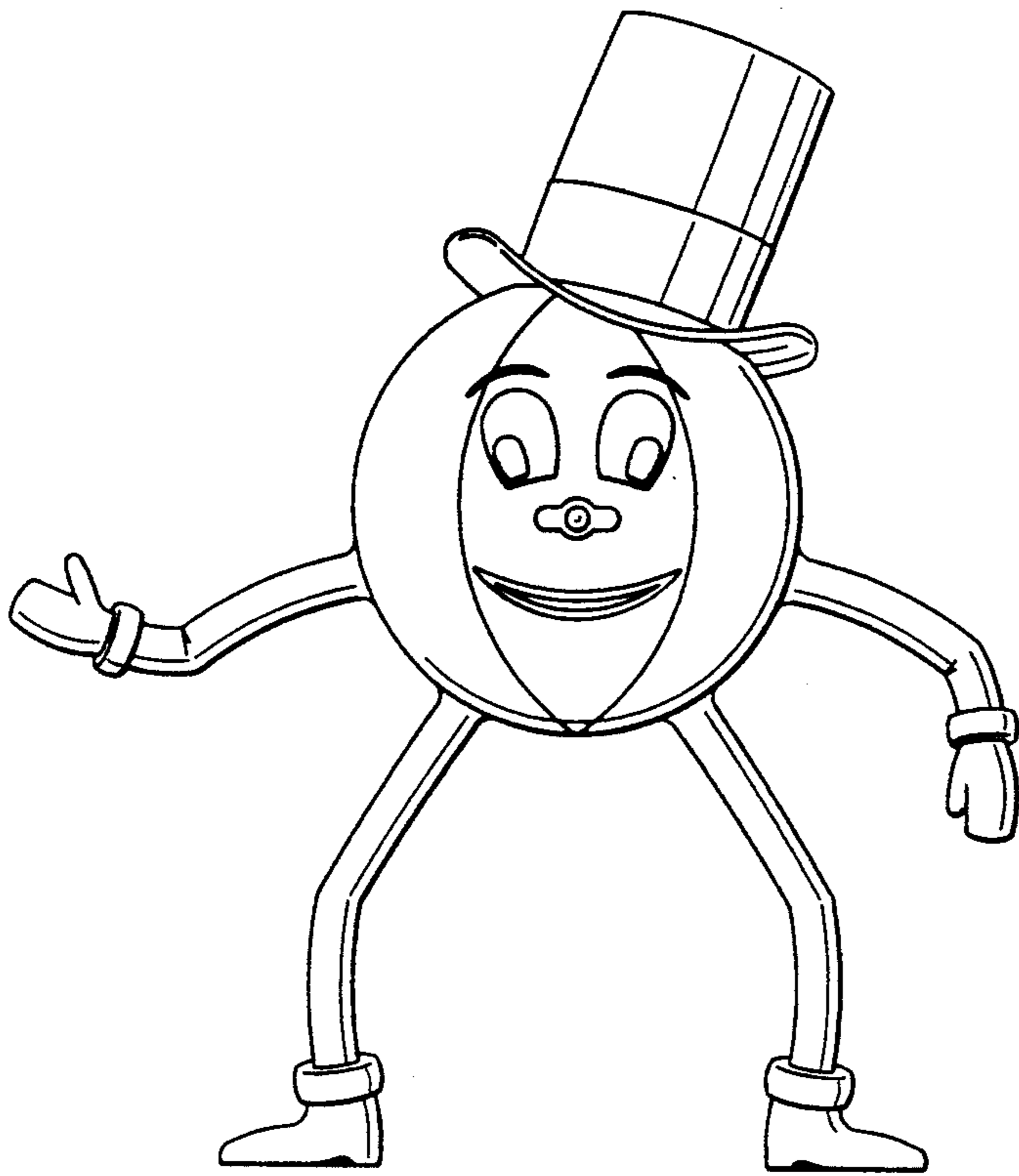

FIG. 1

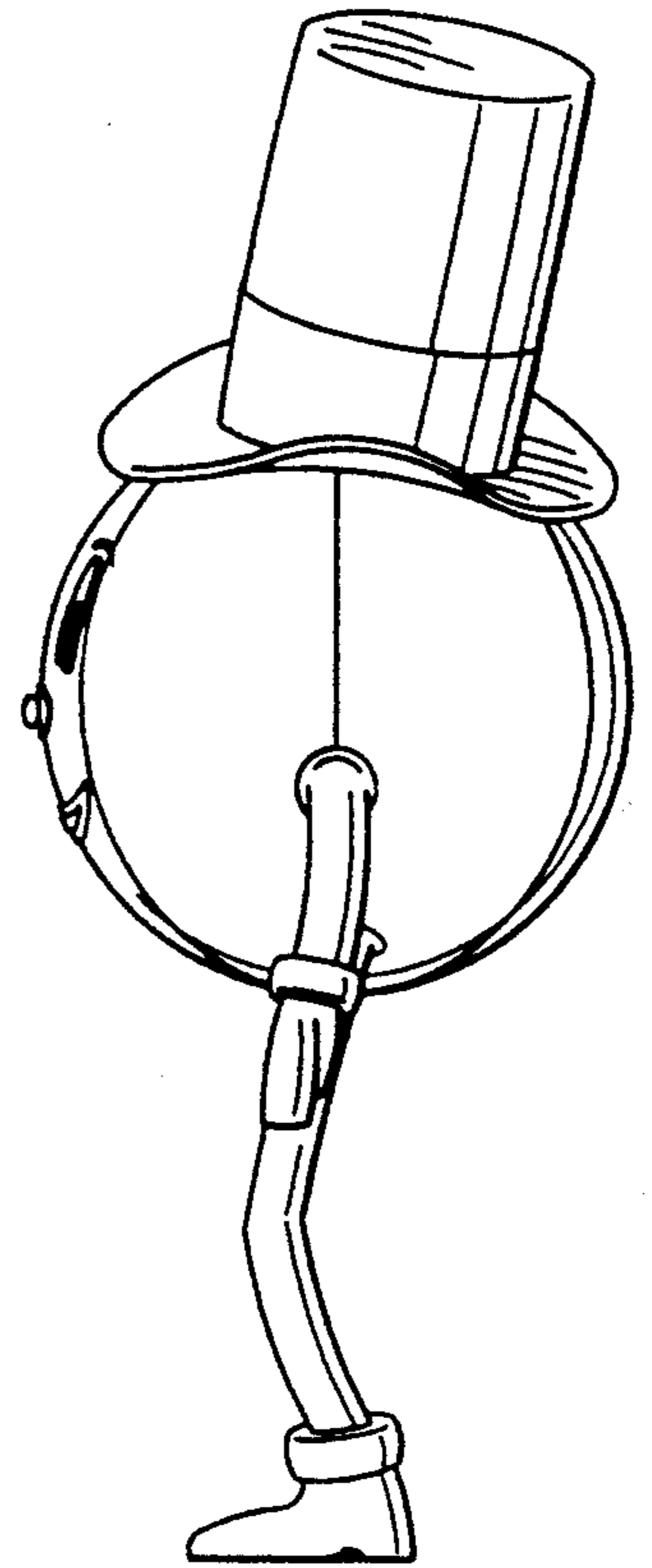

FIG. 2

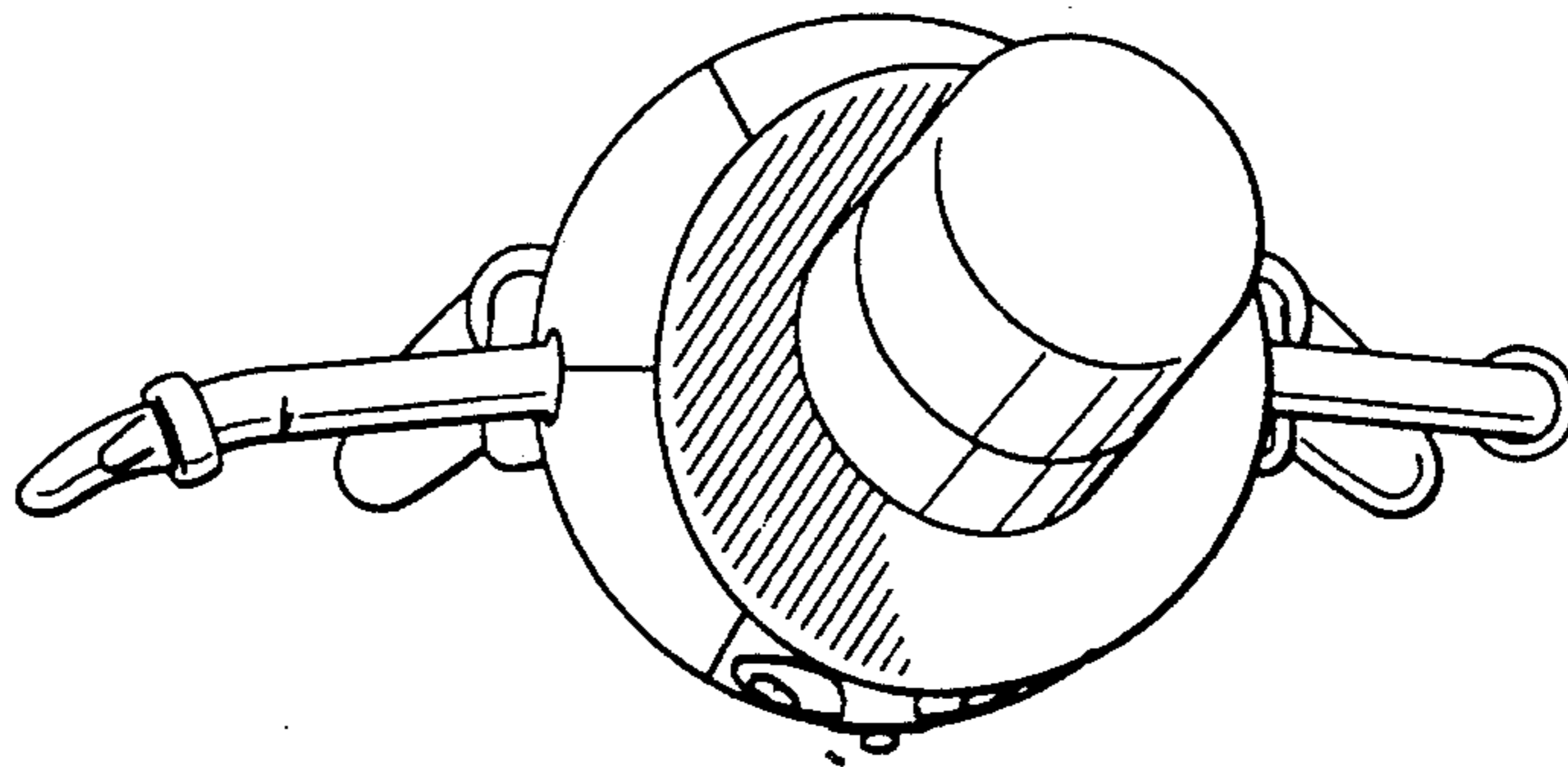

FIG. 3

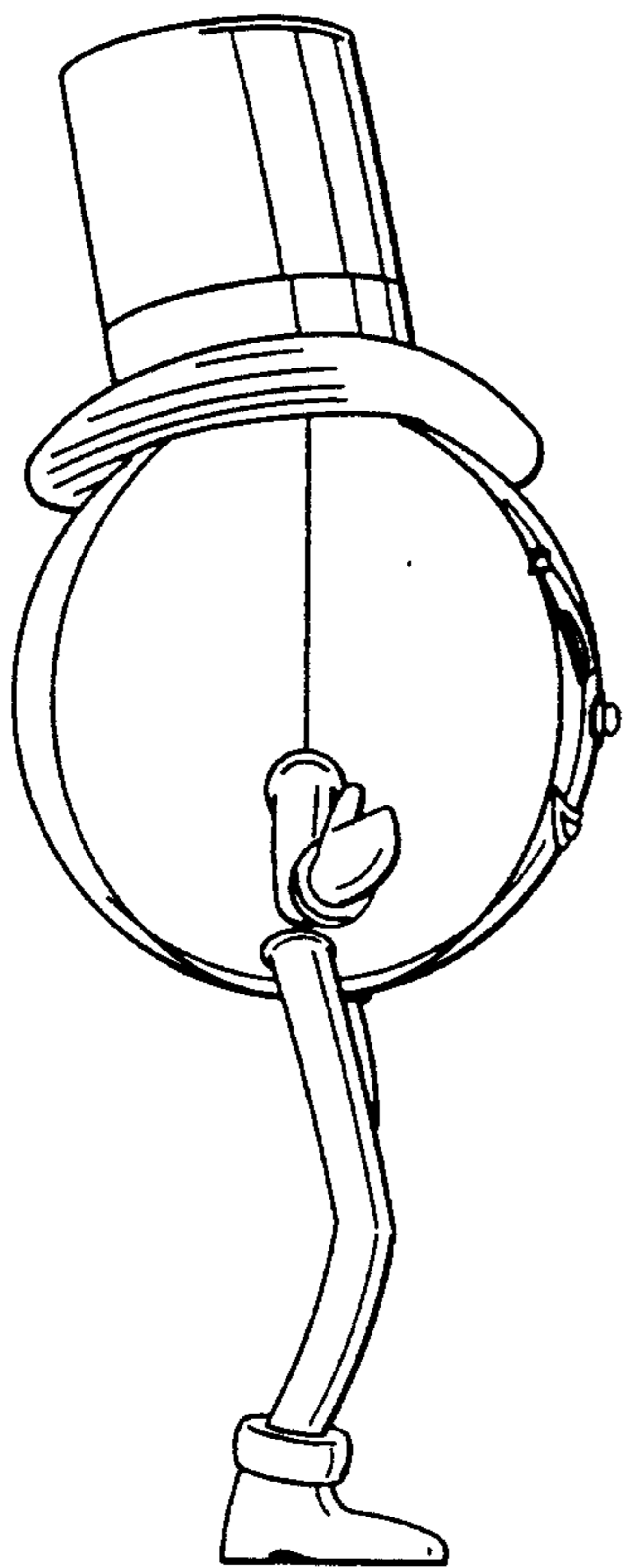

FIG. 4

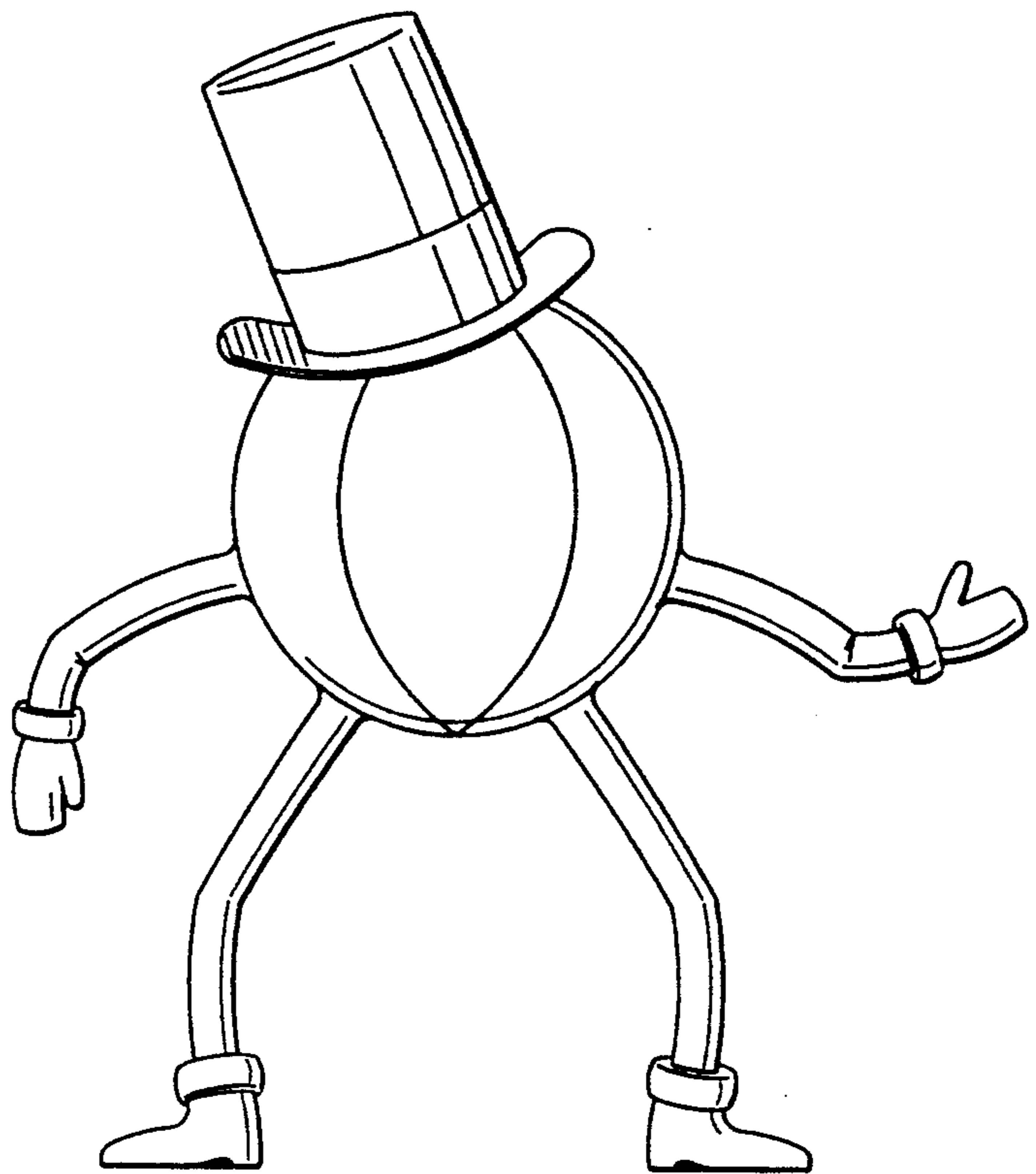

FIG. 5

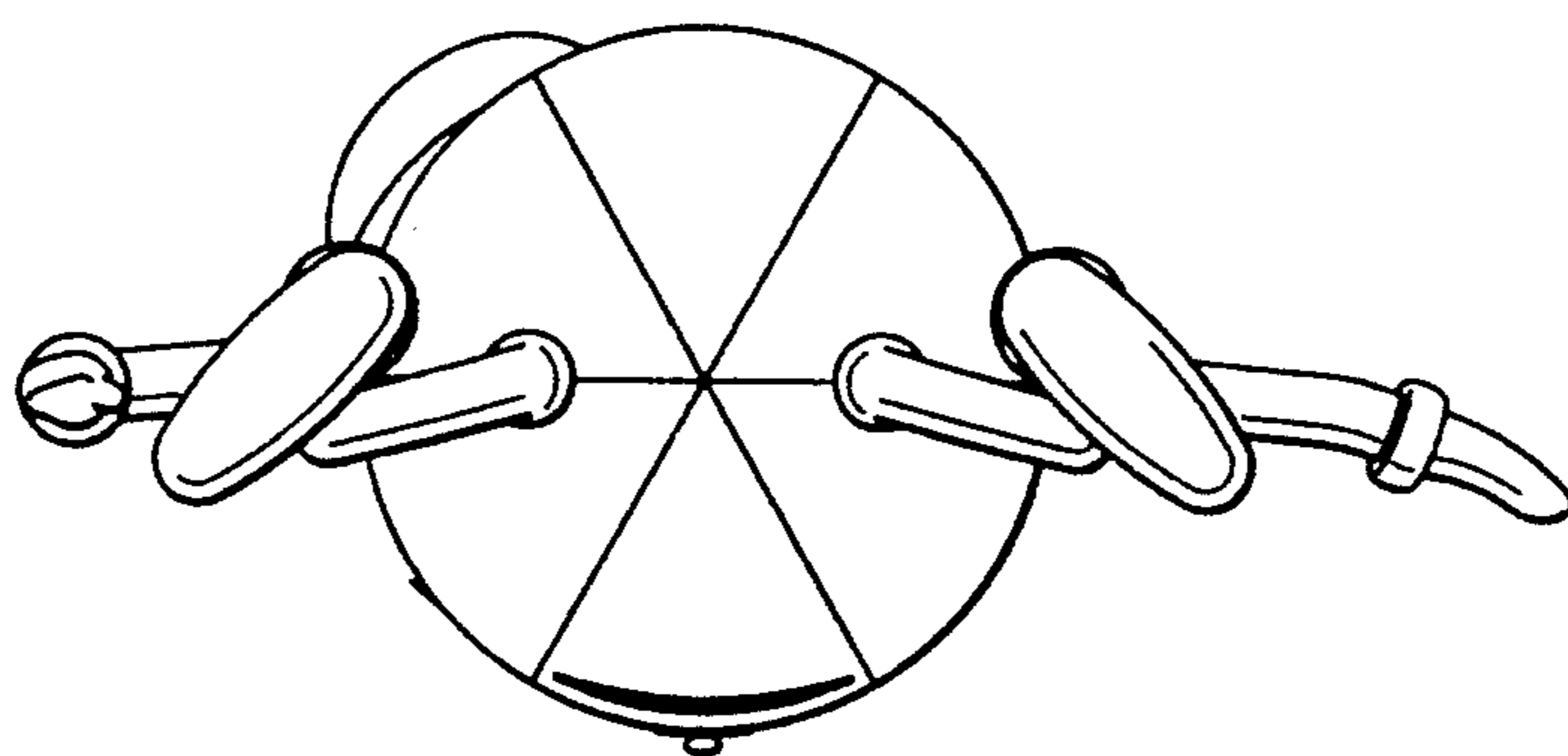

FIG. 6