



US00D342477S

# United States Patent [19]

[11] Patent Number: Des. 342,477

Lovelady et al.

[45] Date of Patent: \*\* Dec. 21, 1993

[54] PORTABLE ANCHOR FOR BOAT DOCKING

### FOREIGN PATENT DOCUMENTS

[76] Inventors: **Hubert G. Lovelady; James S. Anderson**, both of 4702 Lavender La., San Antonio, Tex. 78220

2226998 7/1990 United Kingdom ..... 114/230

*Primary Examiner*—Kay H. Chin

[\*\*] Term: **14 Years**

### [57] CLAIM

[21] Appl. No.: **912,599**

The ornamental design for a portable anchor for boat docking, as shown and described.

[22] Filed: **Jul. 13, 1992**

### DESCRIPTION

[52] U.S. Cl. .... **D12/215; D12/317**

[58] Field of Search ..... **D12/215, 317; 114/301, 114/304, 310, 302, 303, 304, 307, 298, 230; D8/385**

FIG. 1 is a top front perspective view of a portable anchor for boat docking showing our new design; FIG. 2 is a top plan view thereof; FIG. 3 is a rear elevational view thereof; FIG. 4 is a right side elevational view thereof; FIG. 5 is a bottom plan view thereof; FIG. 6 is a left side elevational view thereof; FIG. 7 is a bottom plan view thereof; and, FIG. 8 is a perspective view thereof, the broken lines are for illustrative purposes only.

### [56] References Cited

#### U.S. PATENT DOCUMENTS

2,938,492	5/1960	Kulick .....	114/230
4,899,680	2/1990	Russell, Jr. ....	114/230
4,936,194	6/1990	Horowitz .....	114/230

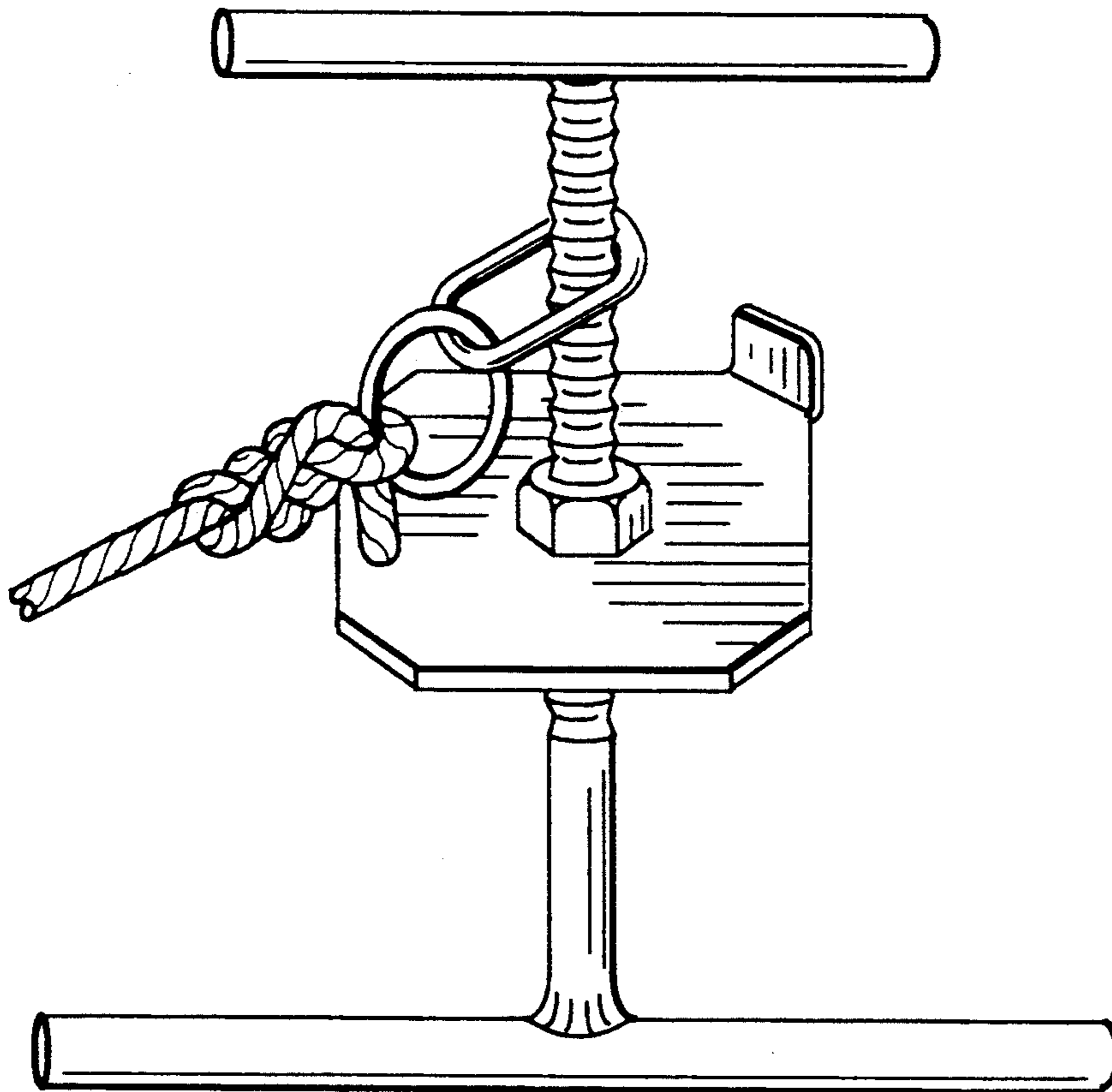

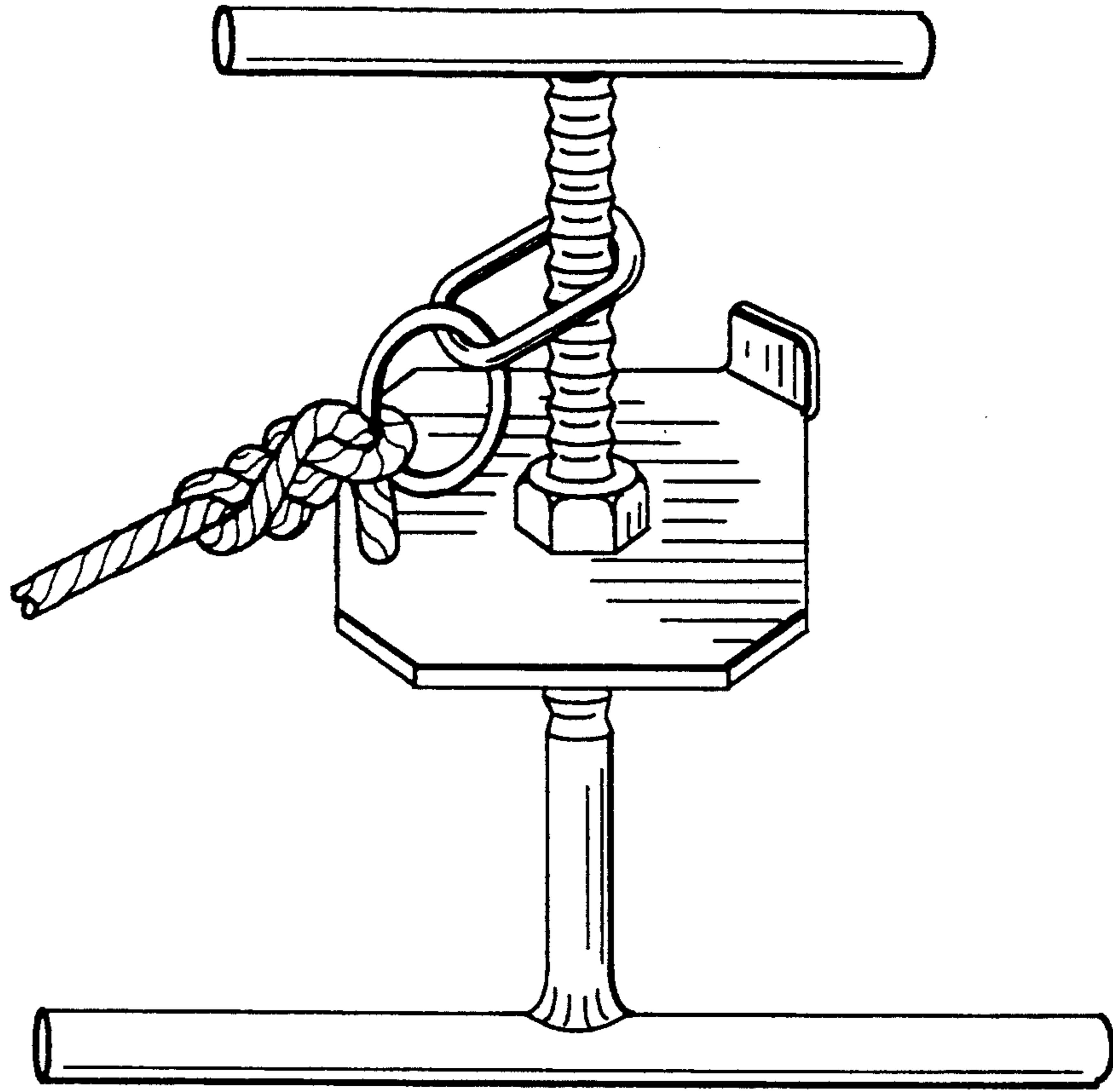

Fig. 1

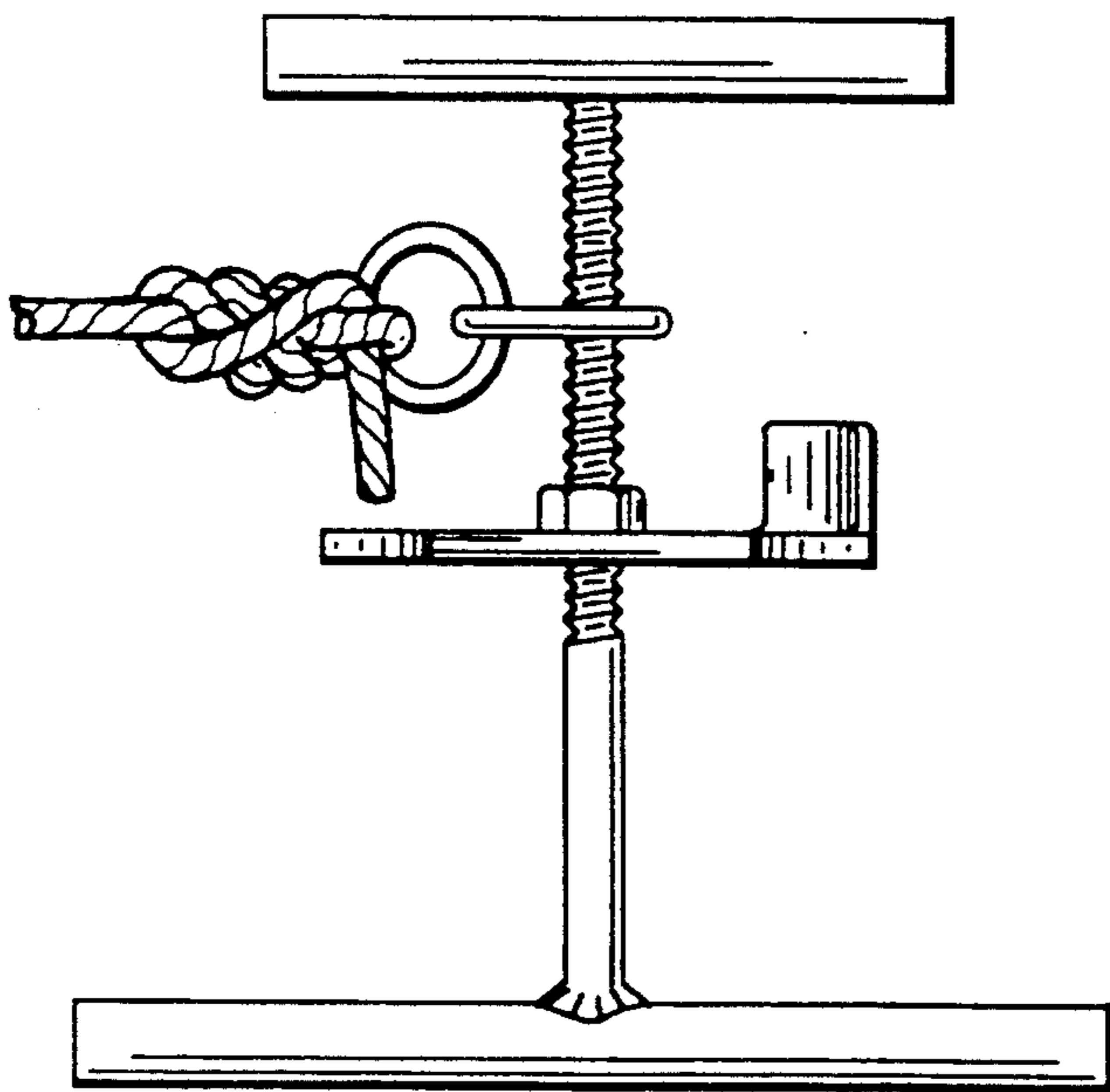

Fig. 5

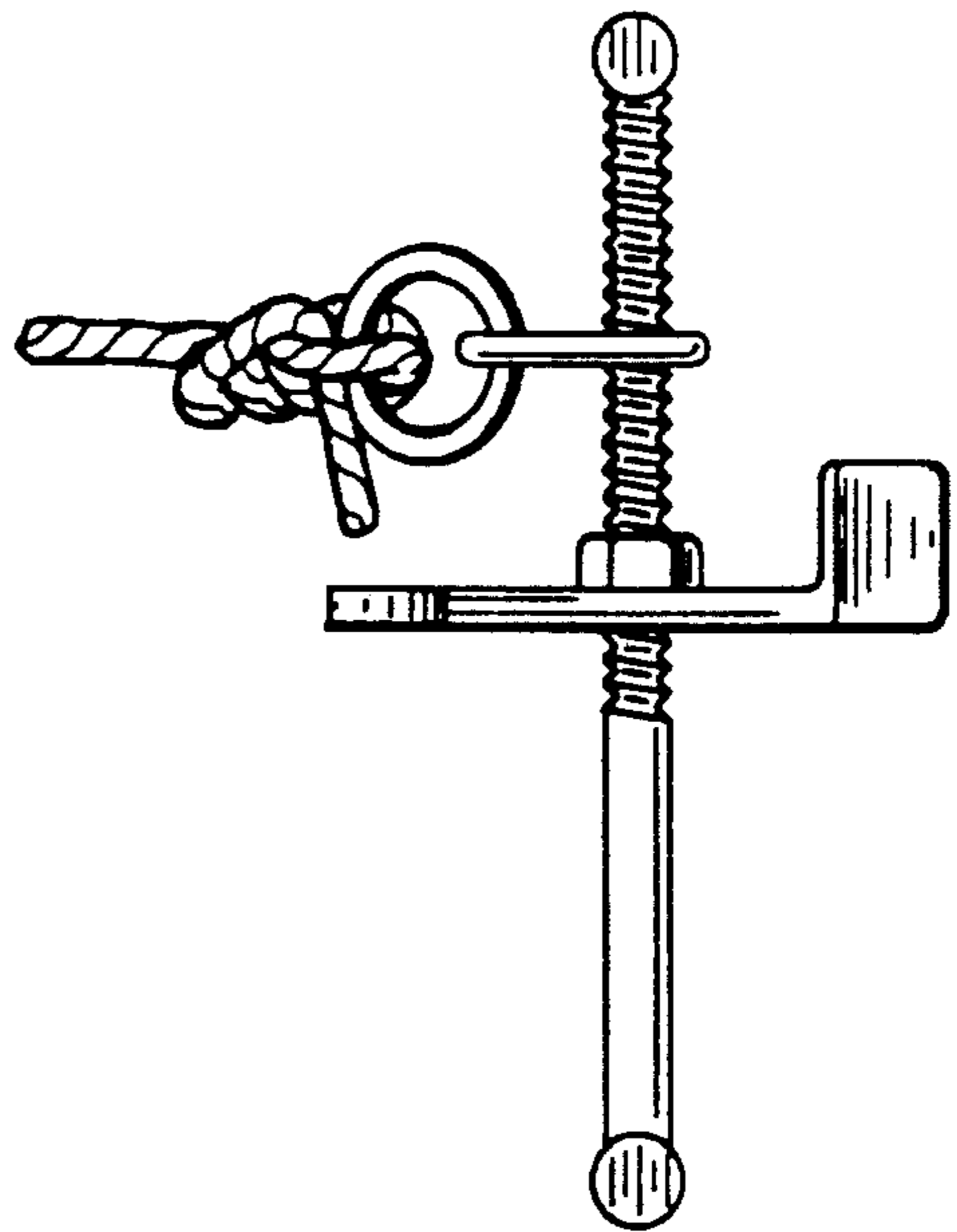

Fig. 6

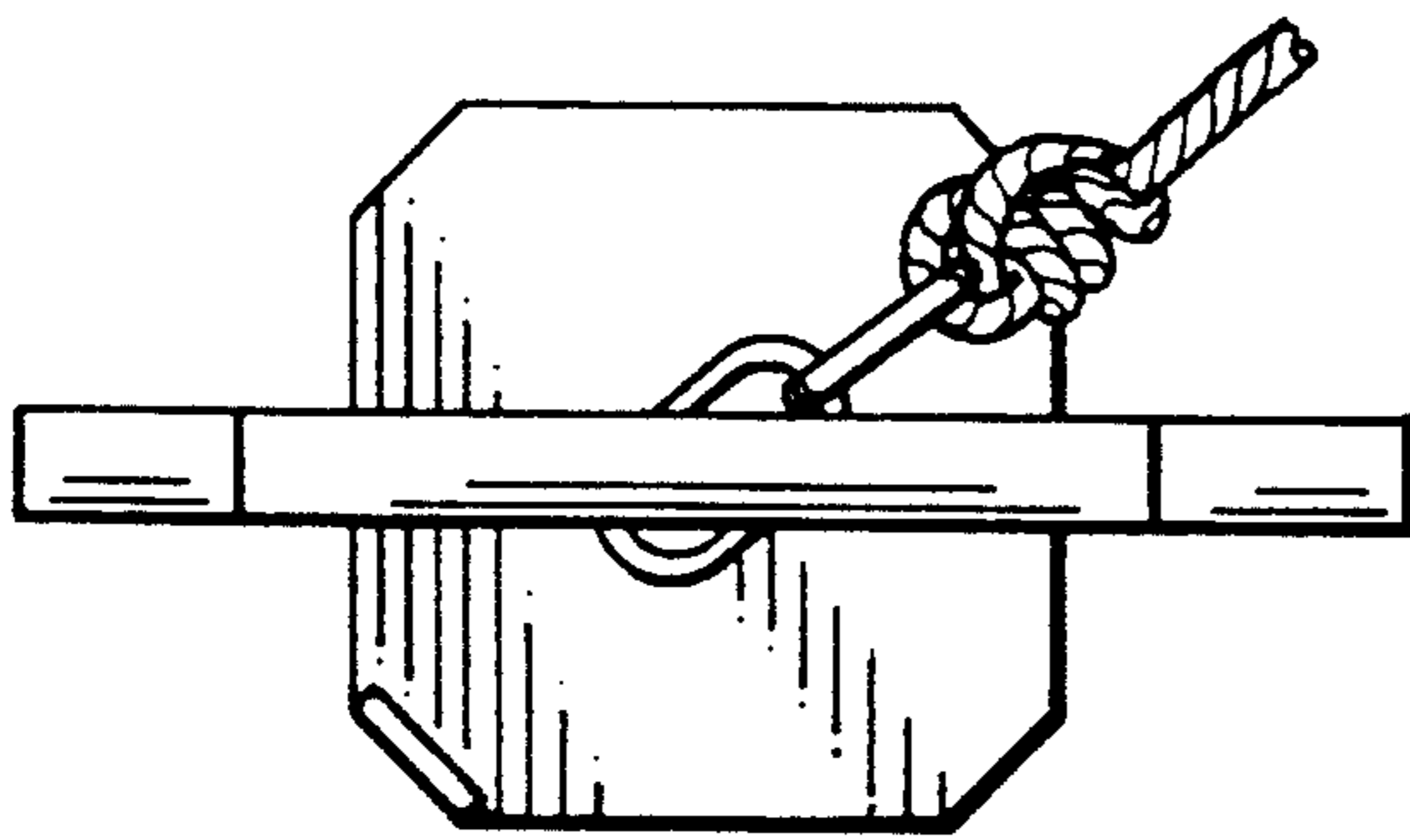

Fig. 2

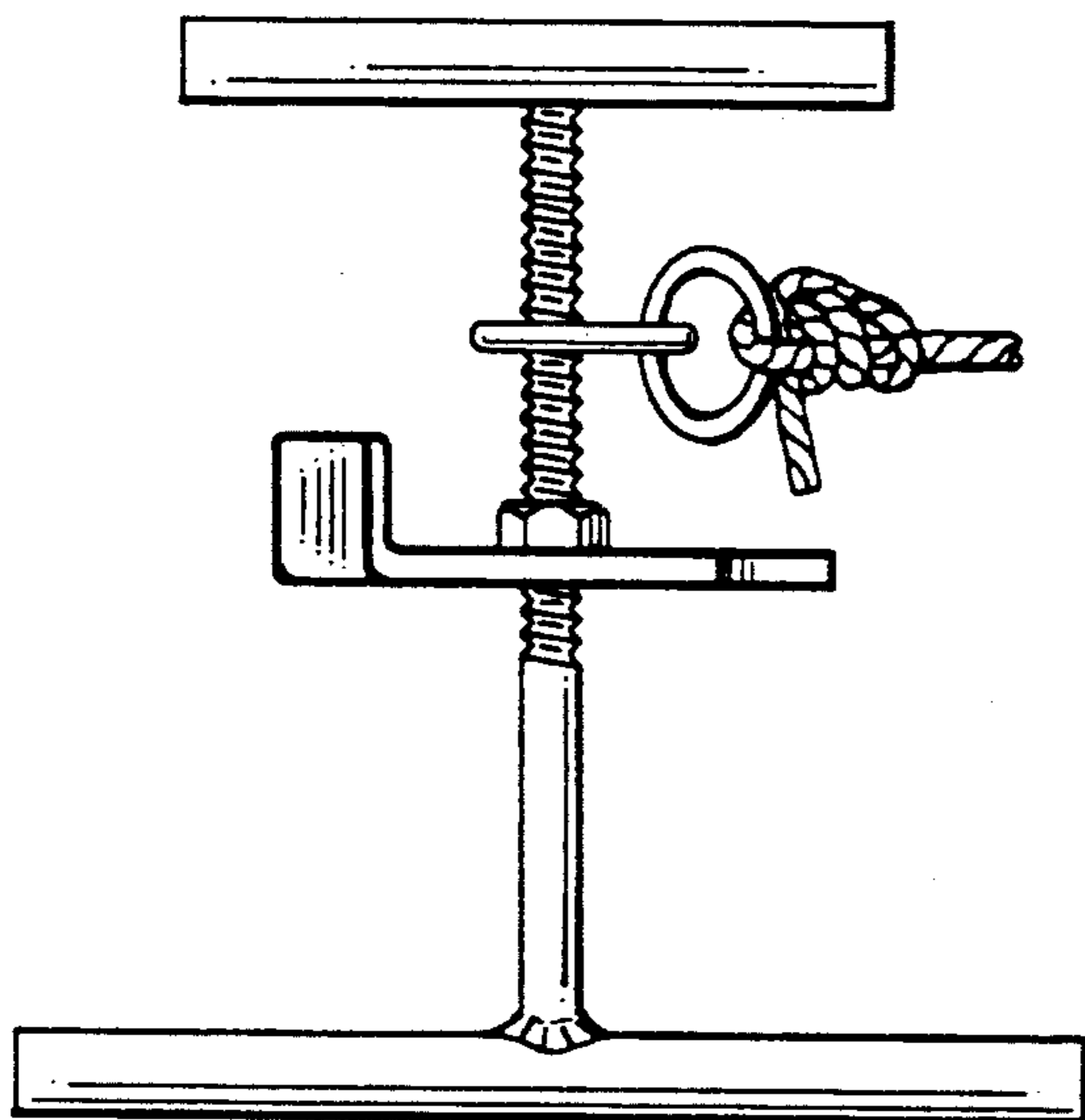

Fig. 3

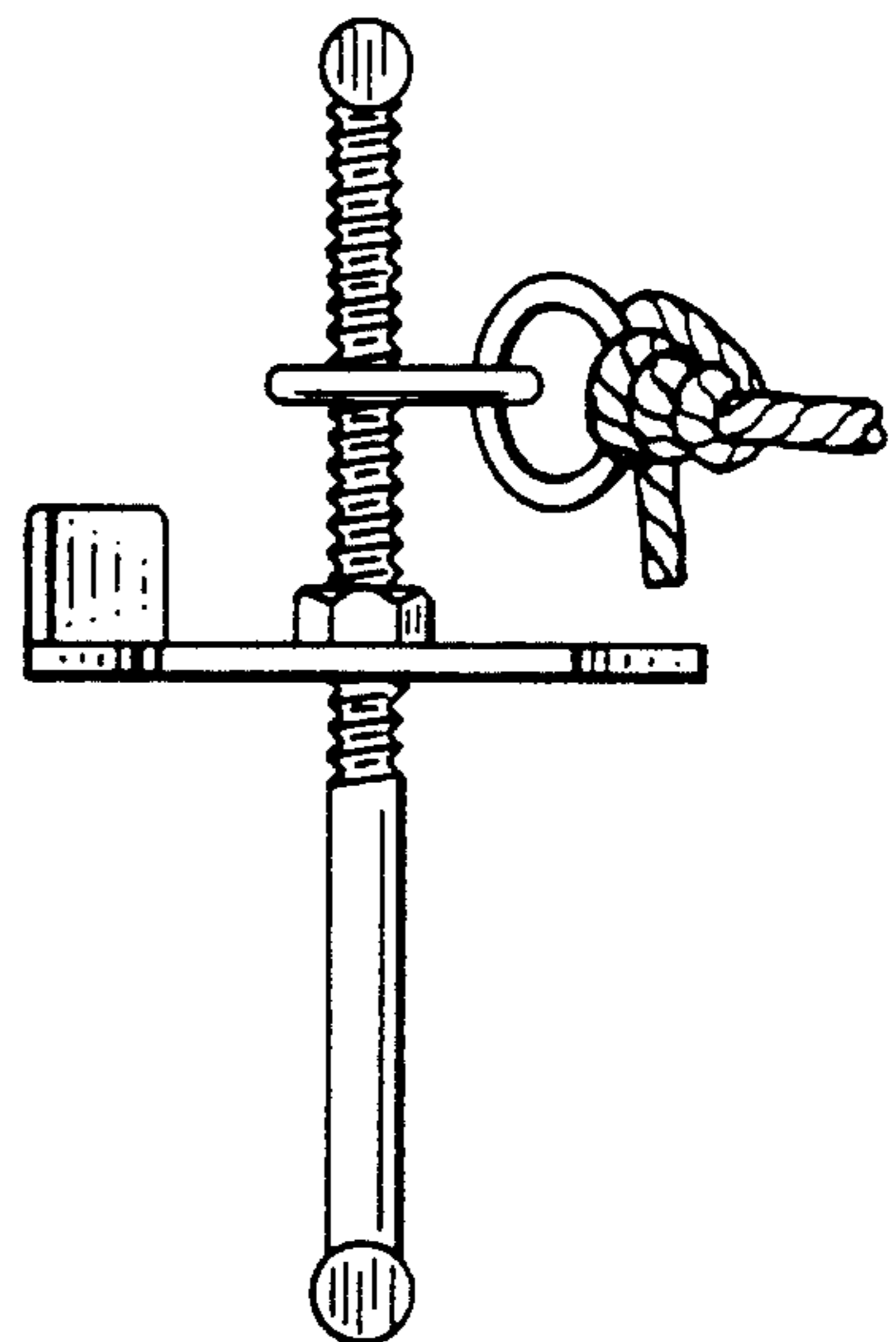

Fig. 4

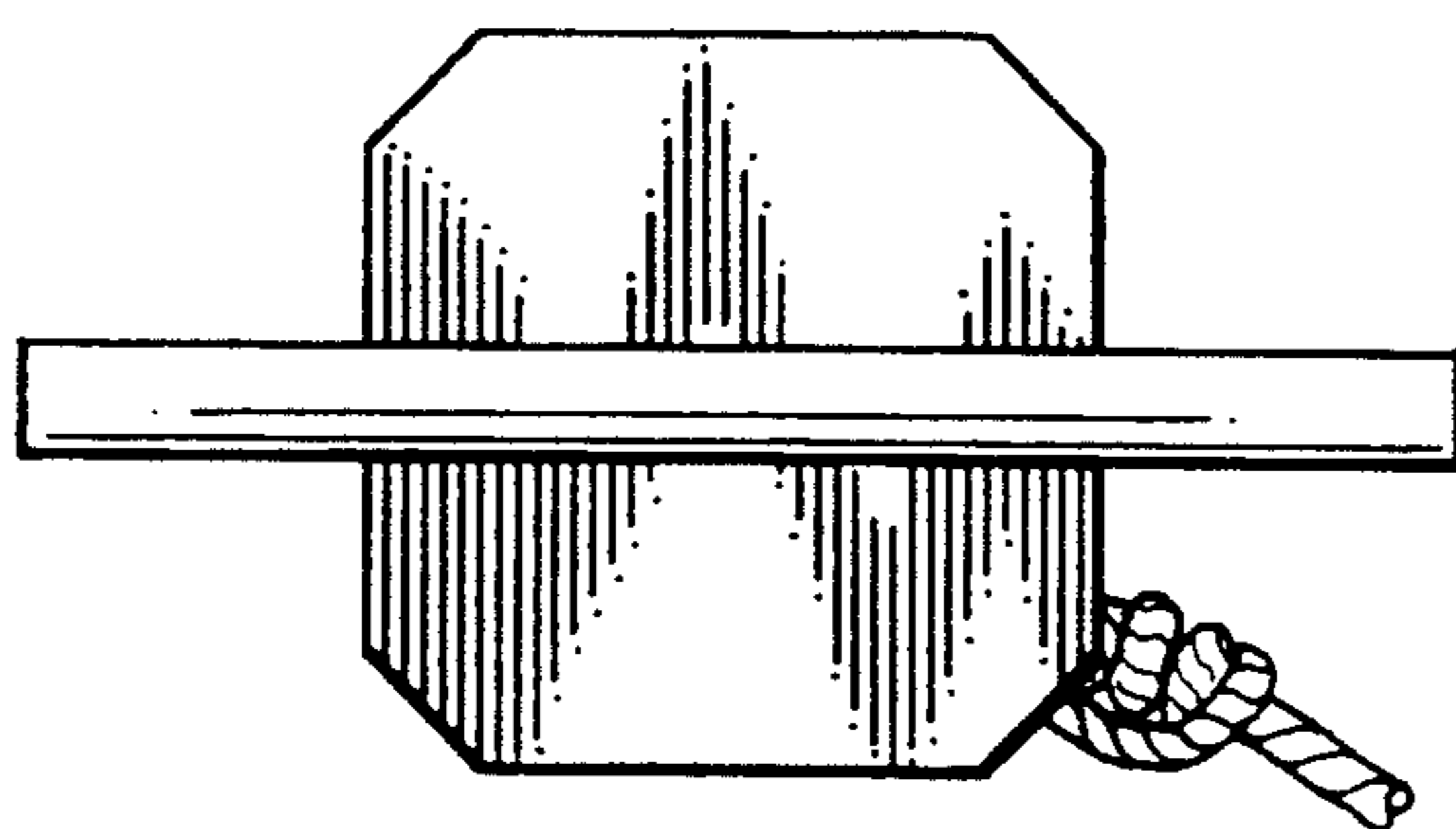

Fig. 7

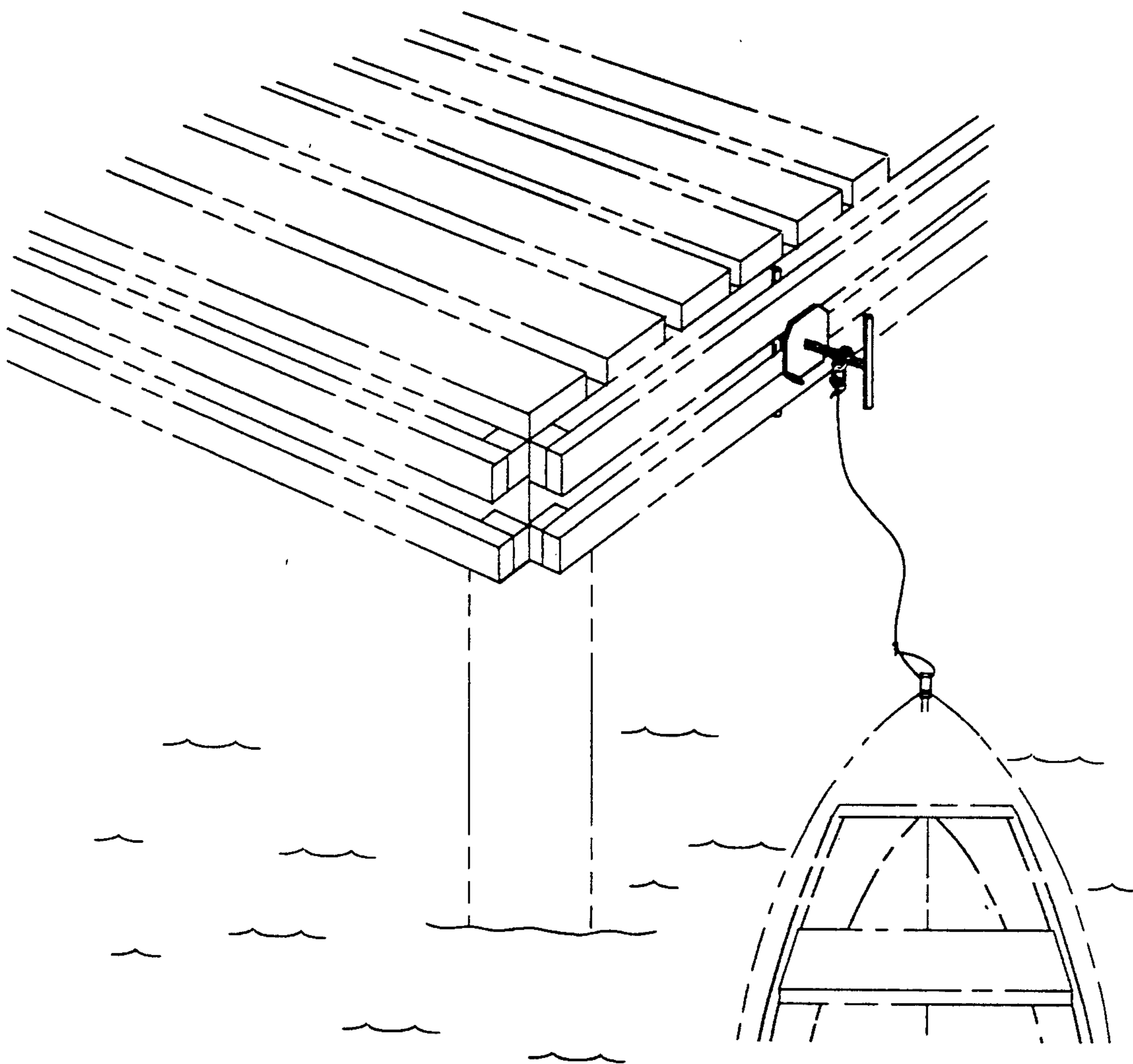

Fig. 8