



US00D342427S

United States Patent [19]
Stovall

[11] **Patent Number: Des. 342,427**

[45] **Date of Patent: ** Dec. 21, 1993**

[54] **EXTENSION HANDLE FOR LUGGAGE CARRIERS**

[76] **Inventor: Chester Stovall, 5009 Willows Ave., Philadelphia, Pa. 19143**

[**] **Term: 14 Years**

[21] **Appl. No.: 886,179**

[22] **Filed: May 21, 1992**

[52] **U.S. Cl. D8/14; D8/107; D34/24**

[58] **Field of Search D8/14, 107, 300; 34/24; 16/114 B, 125; 190/18 A; 294/15, 141, 153, 165, 167**

[56] **References Cited**

U.S. PATENT DOCUMENTS

3,963,104	6/1976	Lautin	190/58 R
4,036,336	7/1977	Burtley	190/18 A
4,299,313	11/1981	Null	190/18 A
4,529,240	7/1985	Engel	294/165

4,696,505	9/1987	Shadoan	294/167
4,832,393	5/1989	Pitchford	294/156
5,022,574	6/1991	Cesari	190/18 A

Primary Examiner—Bernard Ansher
Assistant Examiner—Philip Hyder
Attorney, Agent, or Firm—Terry M. Gernstein

[57] **CLAIM**

The ornamental design for a extension handle for luggage carriers, as shown and described.

DESCRIPTION

FIG. 1 is a top, front and side perspective view of the extension handle for luggage carriers showing my new design;
FIG. 2 is a front elevational view thereof;
FIG. 3 is a rear elevational view thereof;
FIG. 4 is a right side elevational view thereof;
FIG. 5 is a left side elevational view thereof;
FIG. 6 is a top plan view thereof; and,
FIG. 7 is a bottom view thereof.

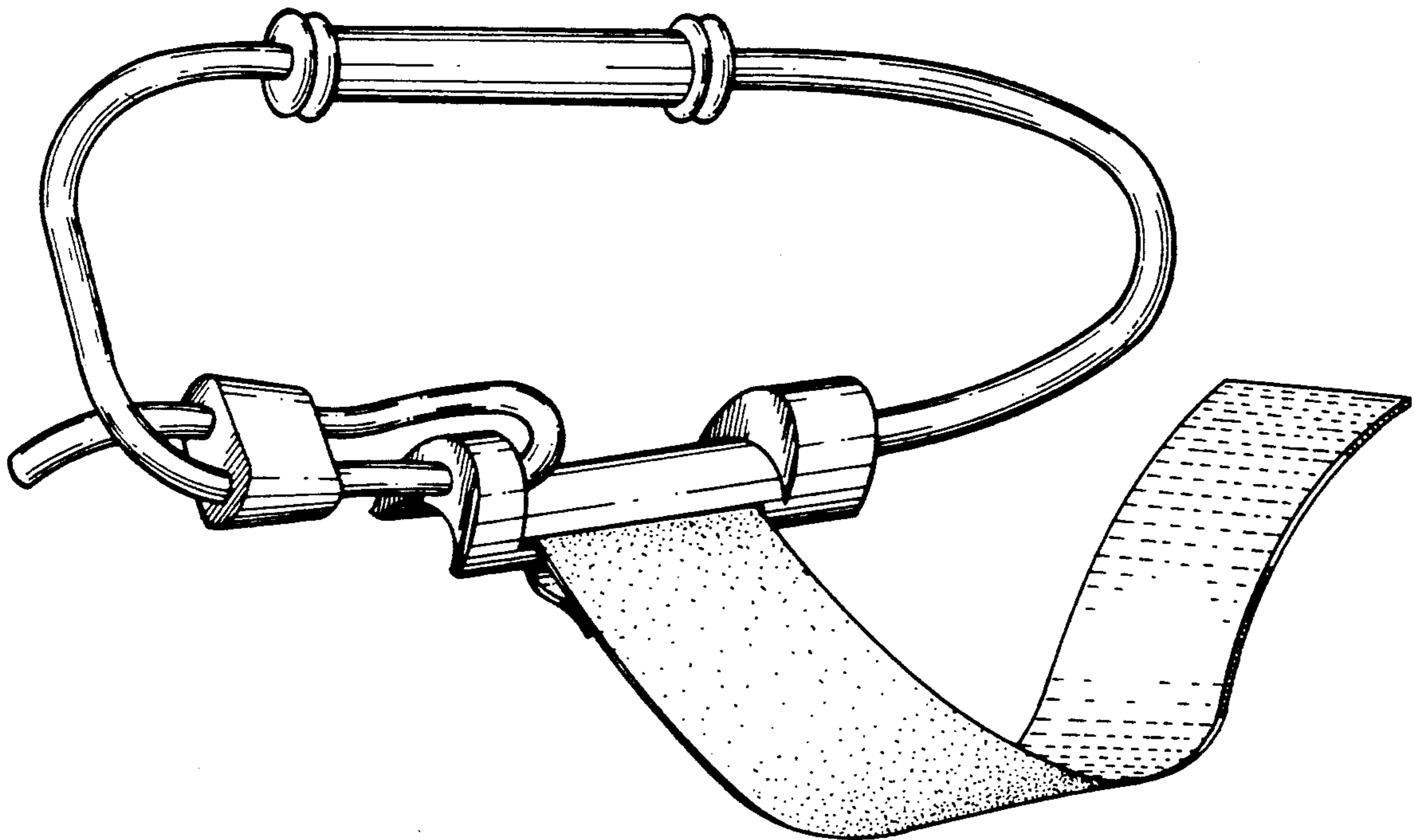

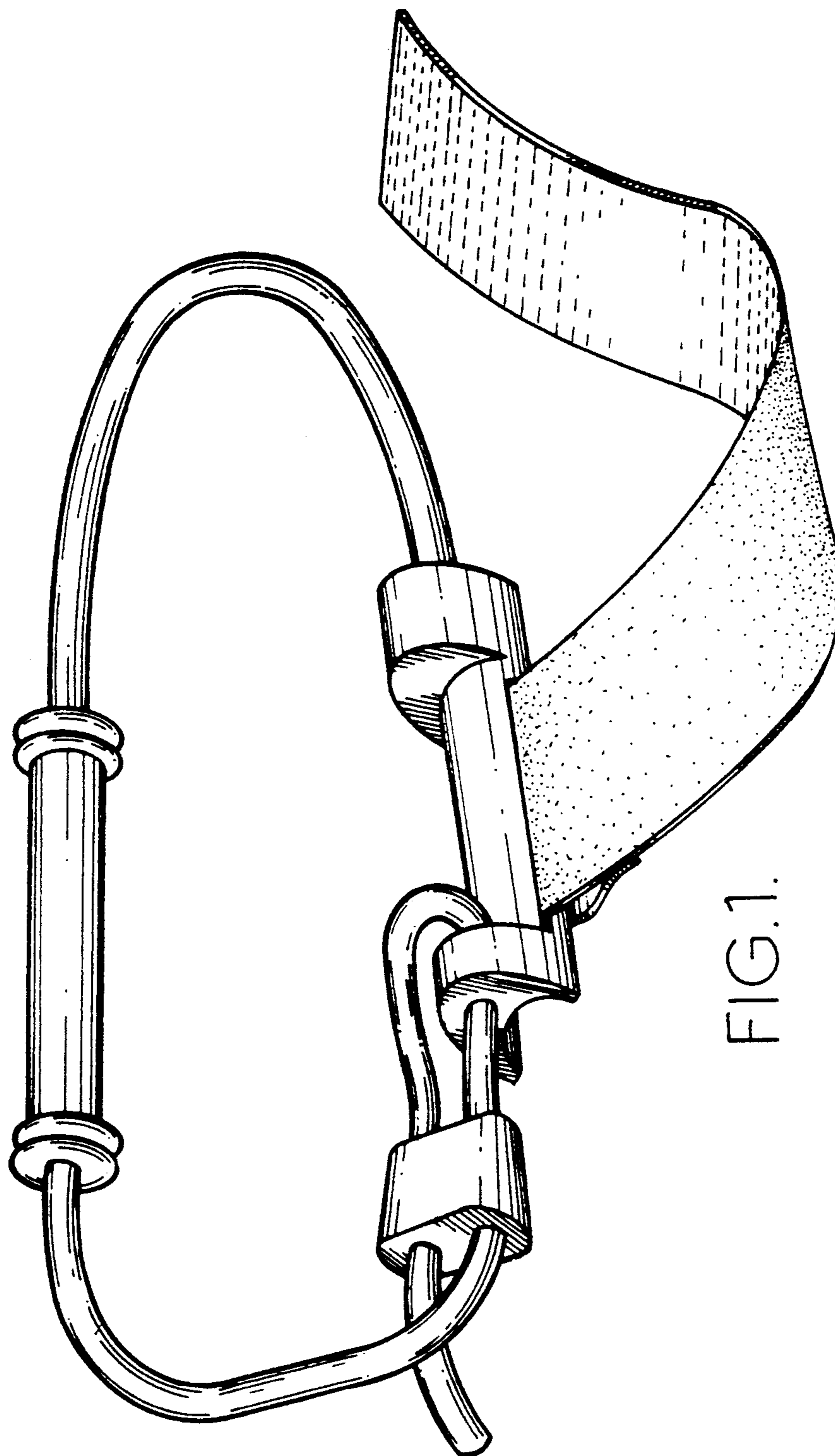

FIG. 1.

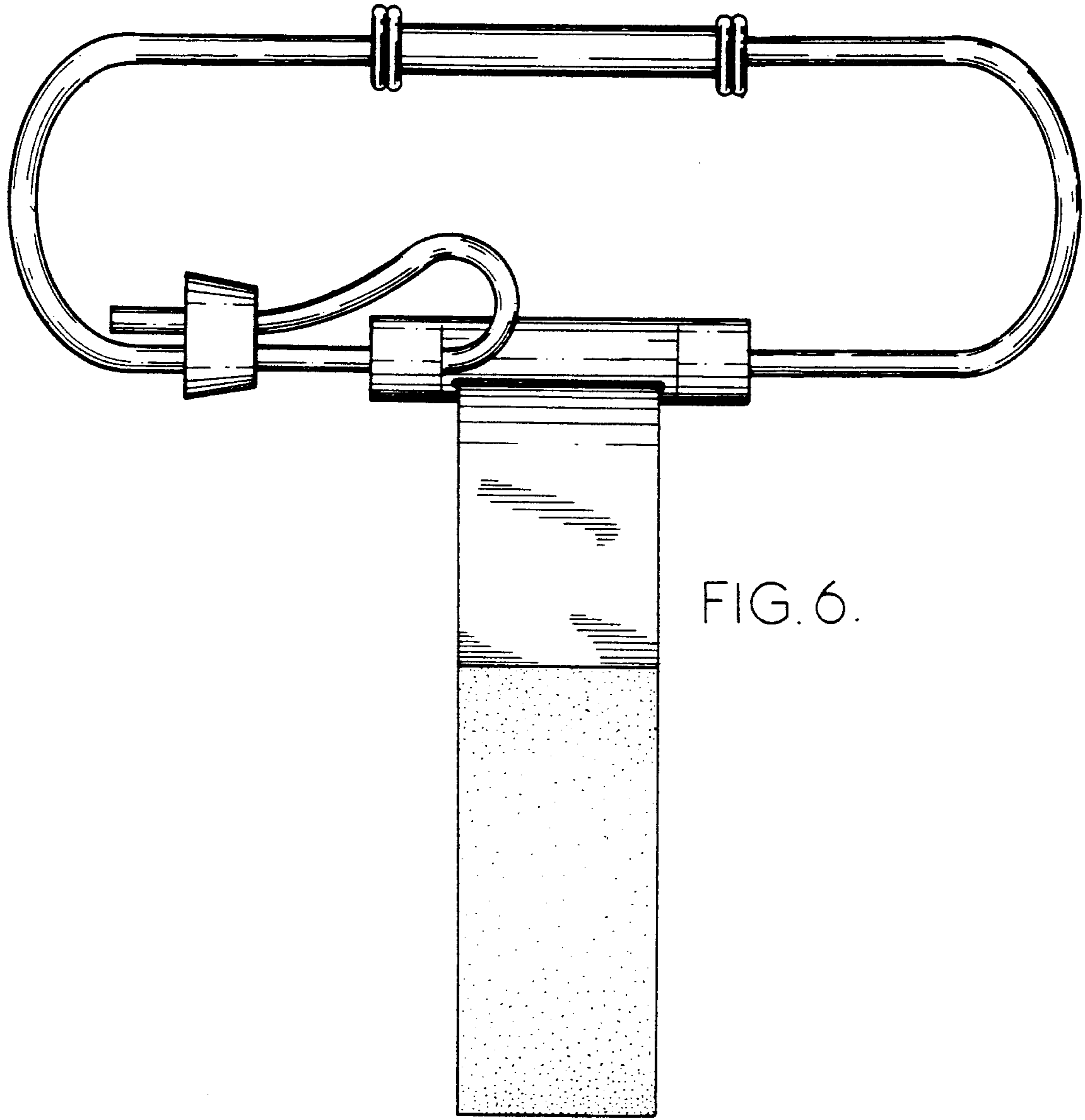
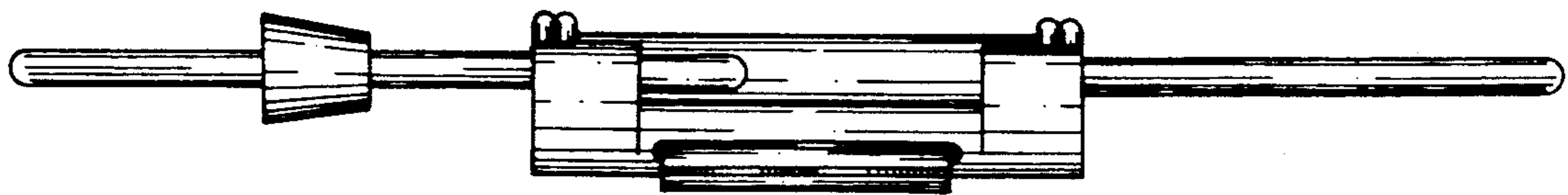

FIG. 6.

FIG. 2.



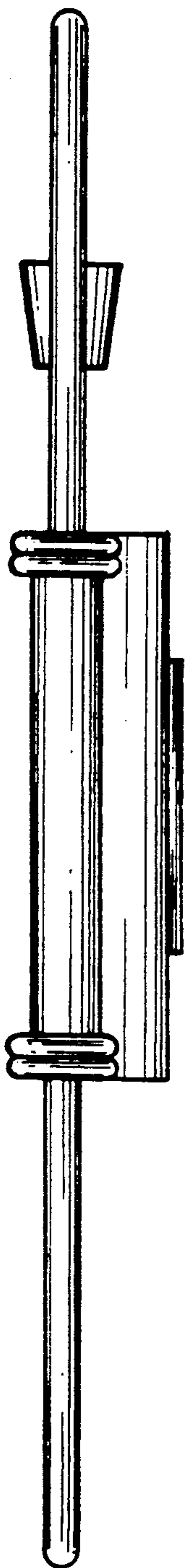

FIG. 3.

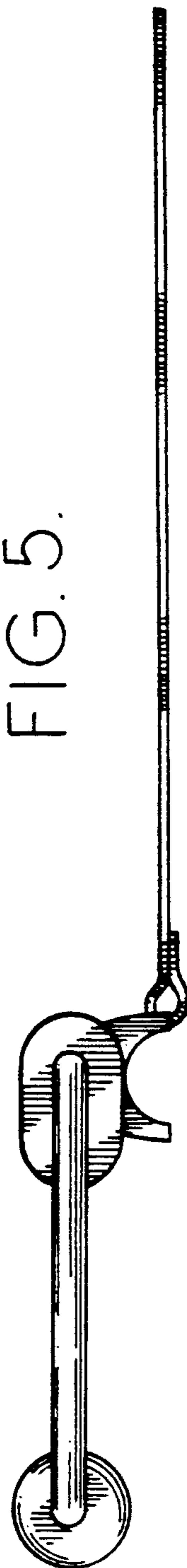

FIG. 5.

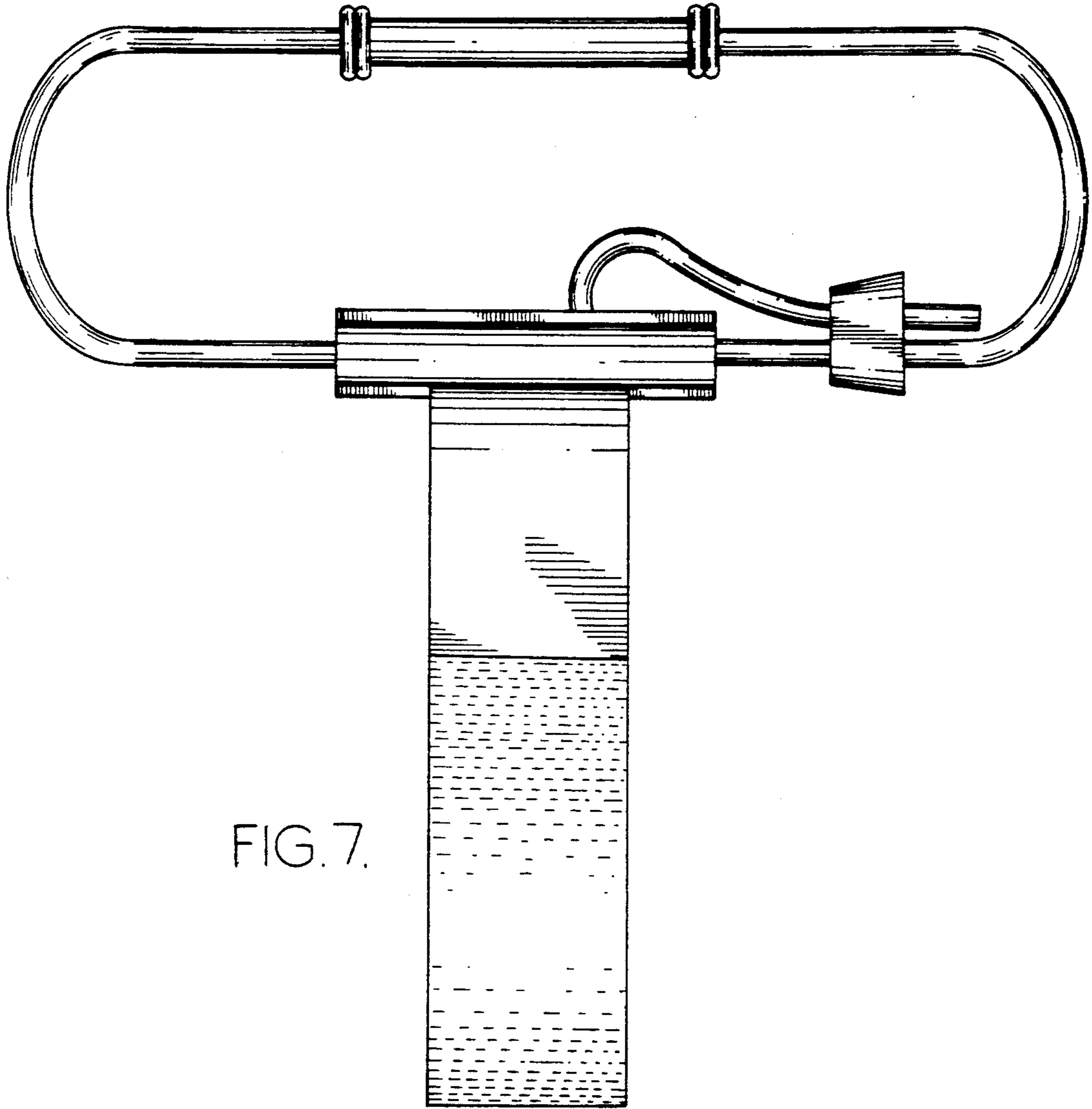

FIG. 7.



FIG. 4.