



US00D342425S

# United States Patent [19]

Watanabe et al.

[11] Patent Number: **Des. 342,425**

[45] Date of Patent: **\*\* Dec. 21, 1993**

[54] **ELECTRIC MOWER**  
[75] Inventors: **Satoru Watanabe; Masakazu Sakamoto**, both of Tokyo, Japan

[73] Assignee: **Ryobi Ltd.**, Hiroshima, Japan

[\*\*] Term: **14 Years**

[21] Appl. No.: **910,388**

[22] Filed: **Jul. 8, 1992**

[30] **Foreign Application Priority Data**

Jan. 21, 1992 [JP] Japan ..... 4-1357

[52] U.S. Cl. .... **D8/8; D15/16**

[58] Field of Search ..... **D8/8; D15/1, 14-18; 30/276, 390, DIG. 5; 56/12.7, 234, 239, 249, 255, 289, 295**

[56] **References Cited**

**U.S. PATENT DOCUMENTS**

D. 290,365	6/1987	Hatano et al. ....	D15/16
D. 292,980	12/1987	Tomita et al. ....	D15/16
D. 326,270	5/1992	Wada et al. ....	D15/16
4,179,805	12/1979	Yamada .....	30/276
4,475,287	10/1984	Beihoffer .....	30/276
4,759,128	7/1988	Katoh et al. ....	56/12.7

4,825,548	5/1989	Driggers .....	30/DIG. 5
4,916,886	4/1990	Nakamura et al. ....	56/12.7
5,142,853	9/1992	Routery .....	56/255

**FOREIGN PATENT DOCUMENTS**

533831 6/1980 Japan .

**OTHER PUBLICATIONS**

Toro Catalog, Jul. 1988, p. 16, "TC 5000" trimmer.

*Primary Examiner*—Bernard Ansher

*Assistant Examiner*—Sandra Morris

*Attorney, Agent, or Firm*—Sughrue, Mion, Zinn, Macpeak & Seas

[57] **CLAIM**

The ornamental design for an electric mower, as shown.

**DESCRIPTION**

FIG. 1 is a front and right side perspective view of an electric mower showing our new design;

FIG. 2 is a left side elevational view thereof;

FIG. 3 is a right side elevational view thereof;

FIG. 4 is a front elevational view thereof;

FIG. 5 is a rear elevational view thereof;

FIG. 6 is a top plan view thereof; and,

FIG. 7 is a bottom plan view thereof.

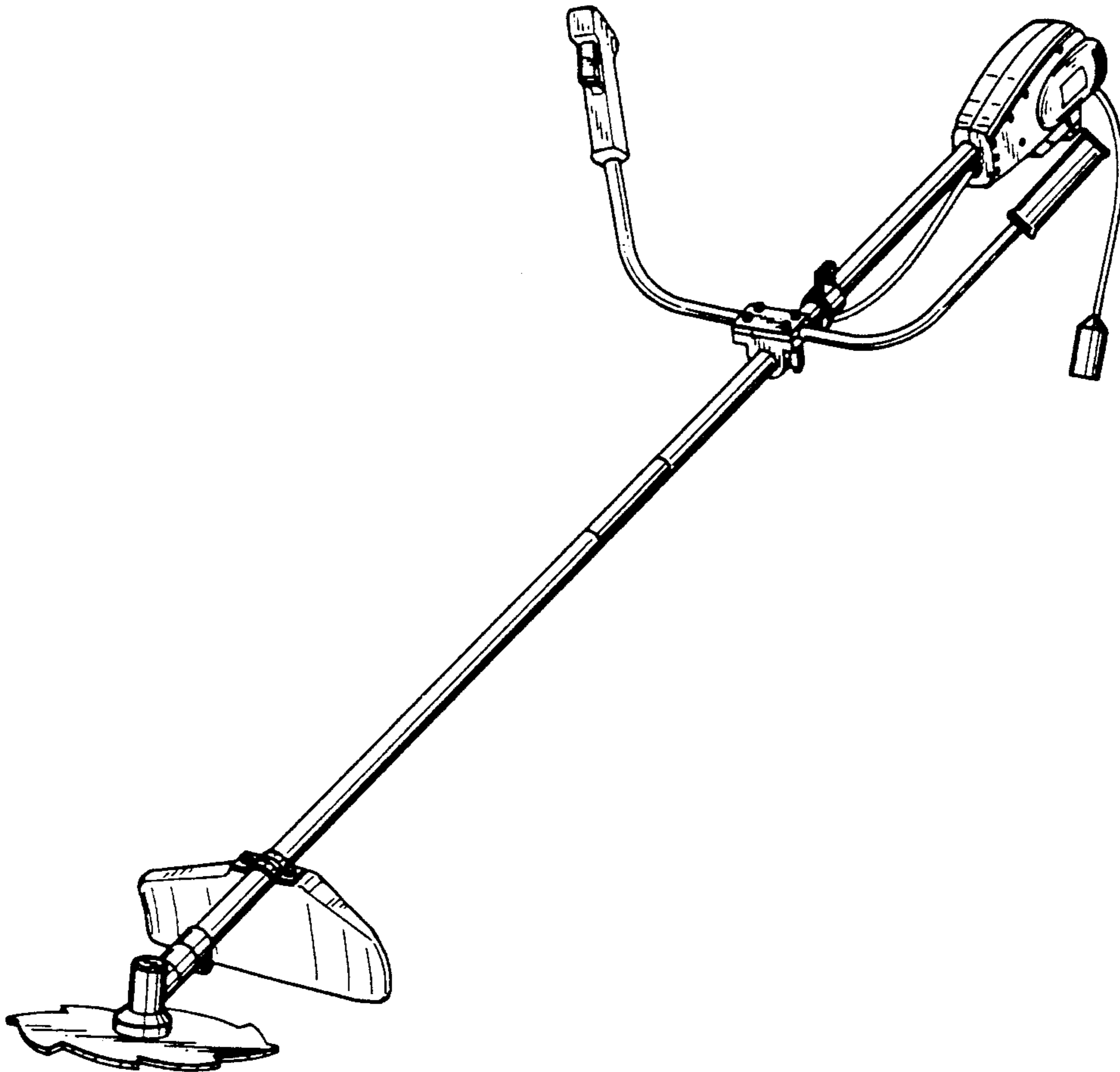

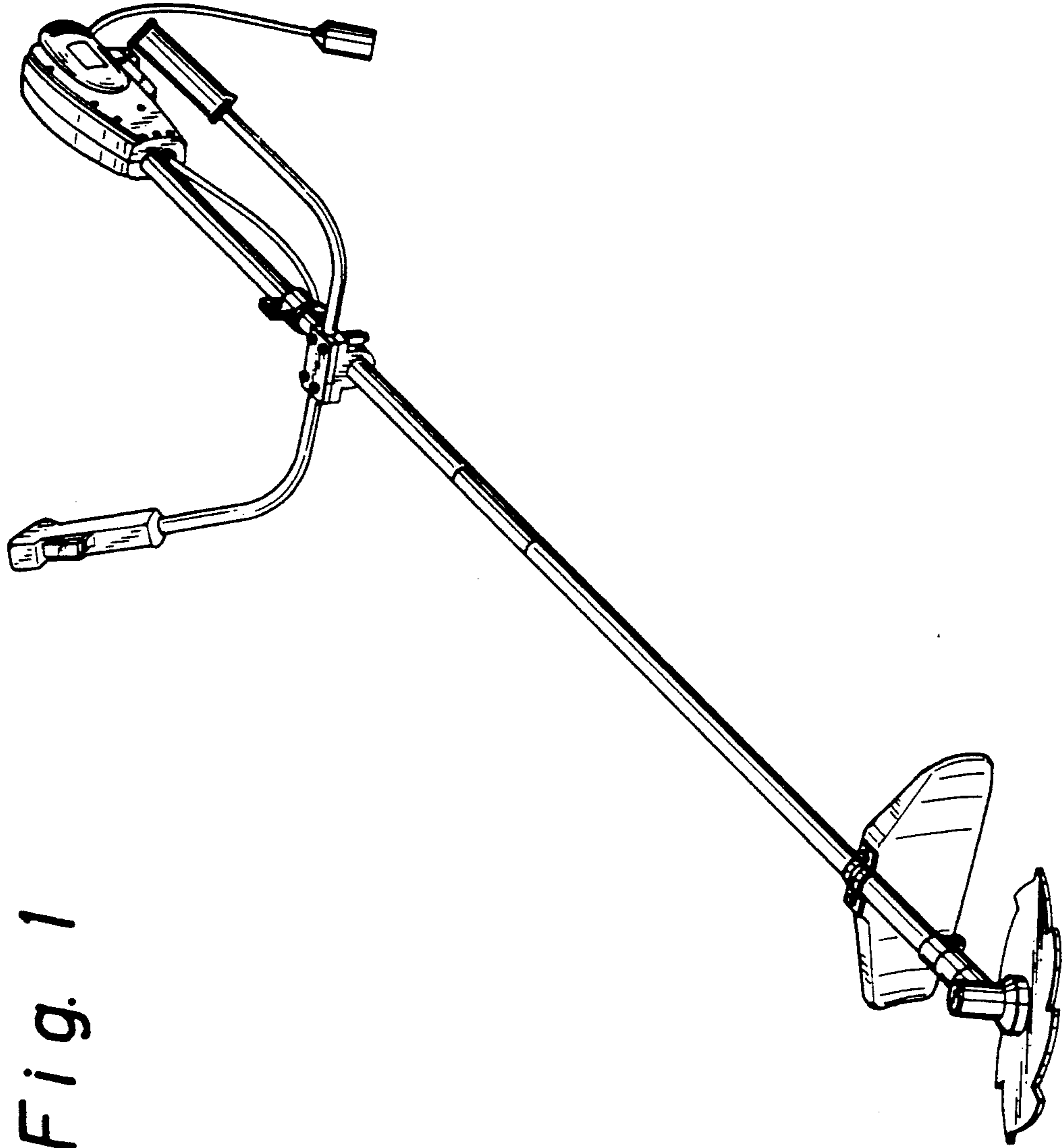
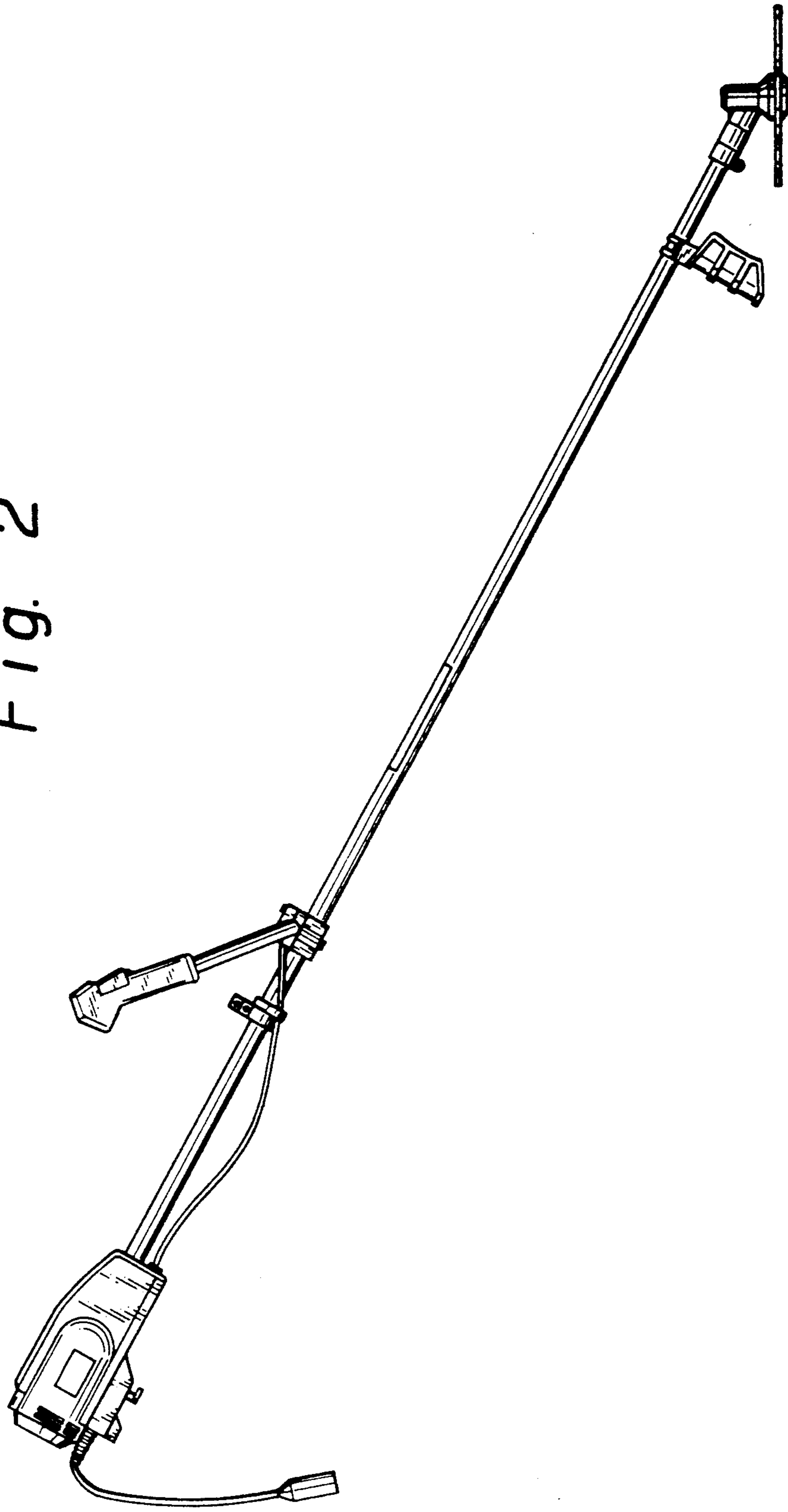

Fig. 1

Fig. 2



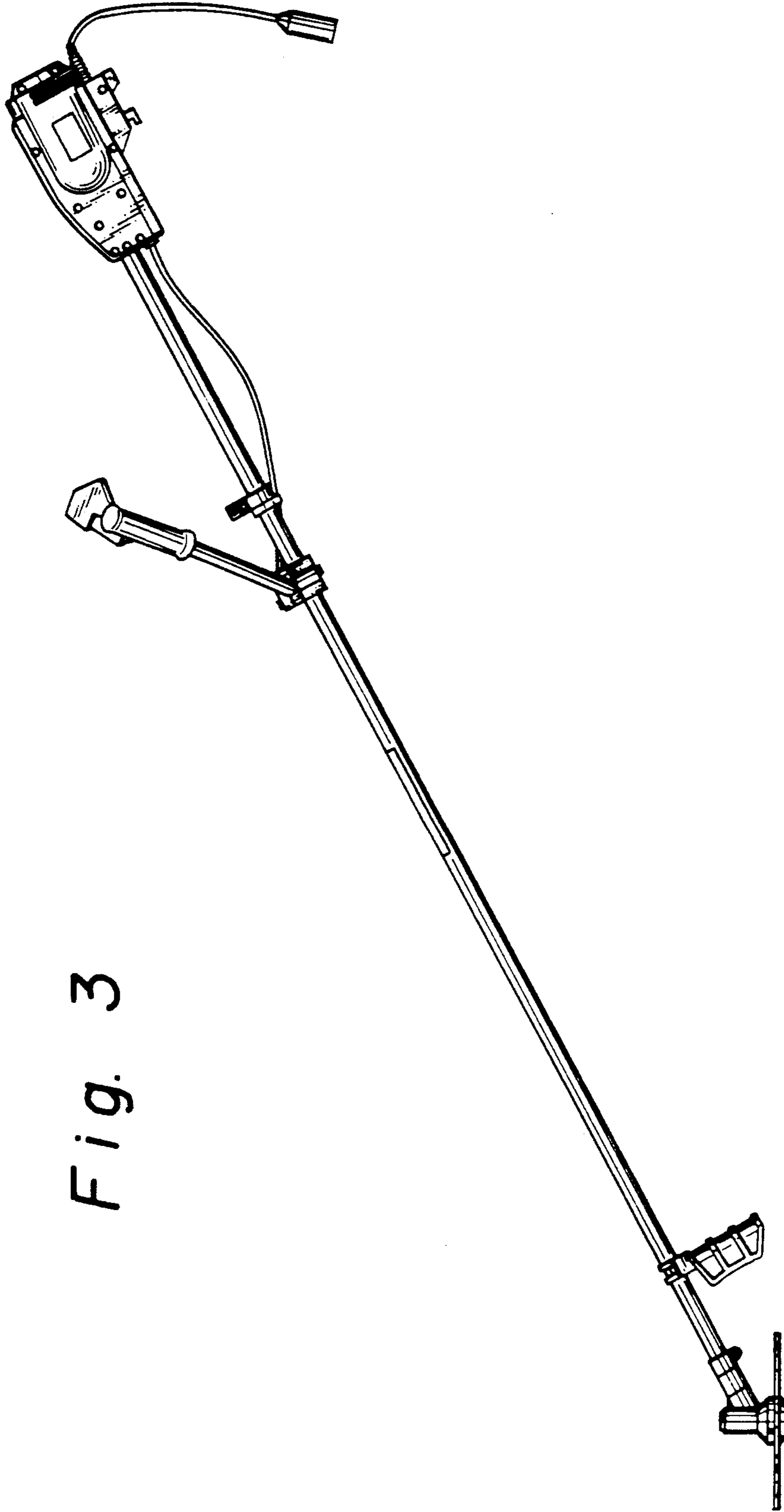
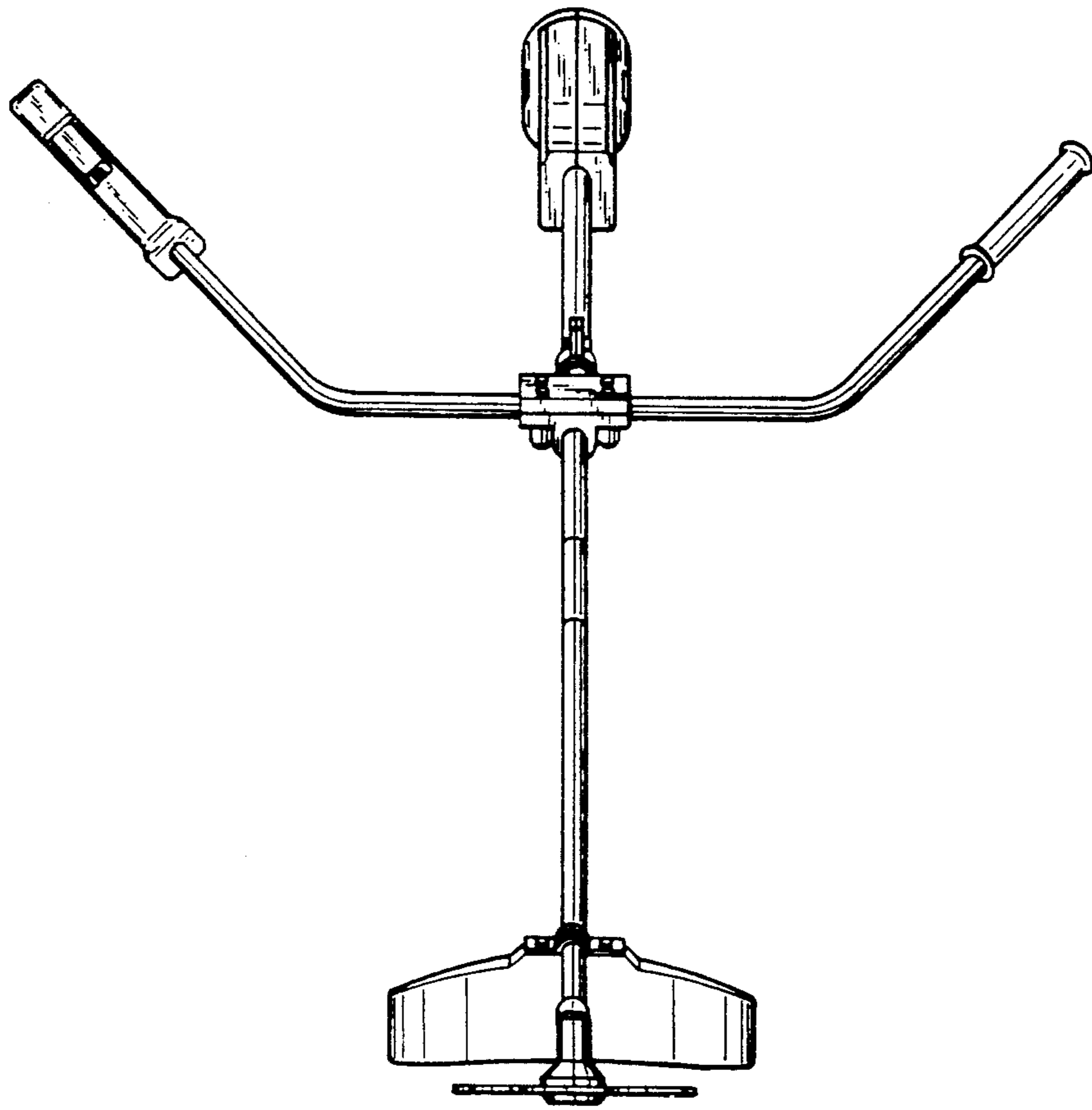

Fig. 3

*Fig. 4*



*Fig. 5*

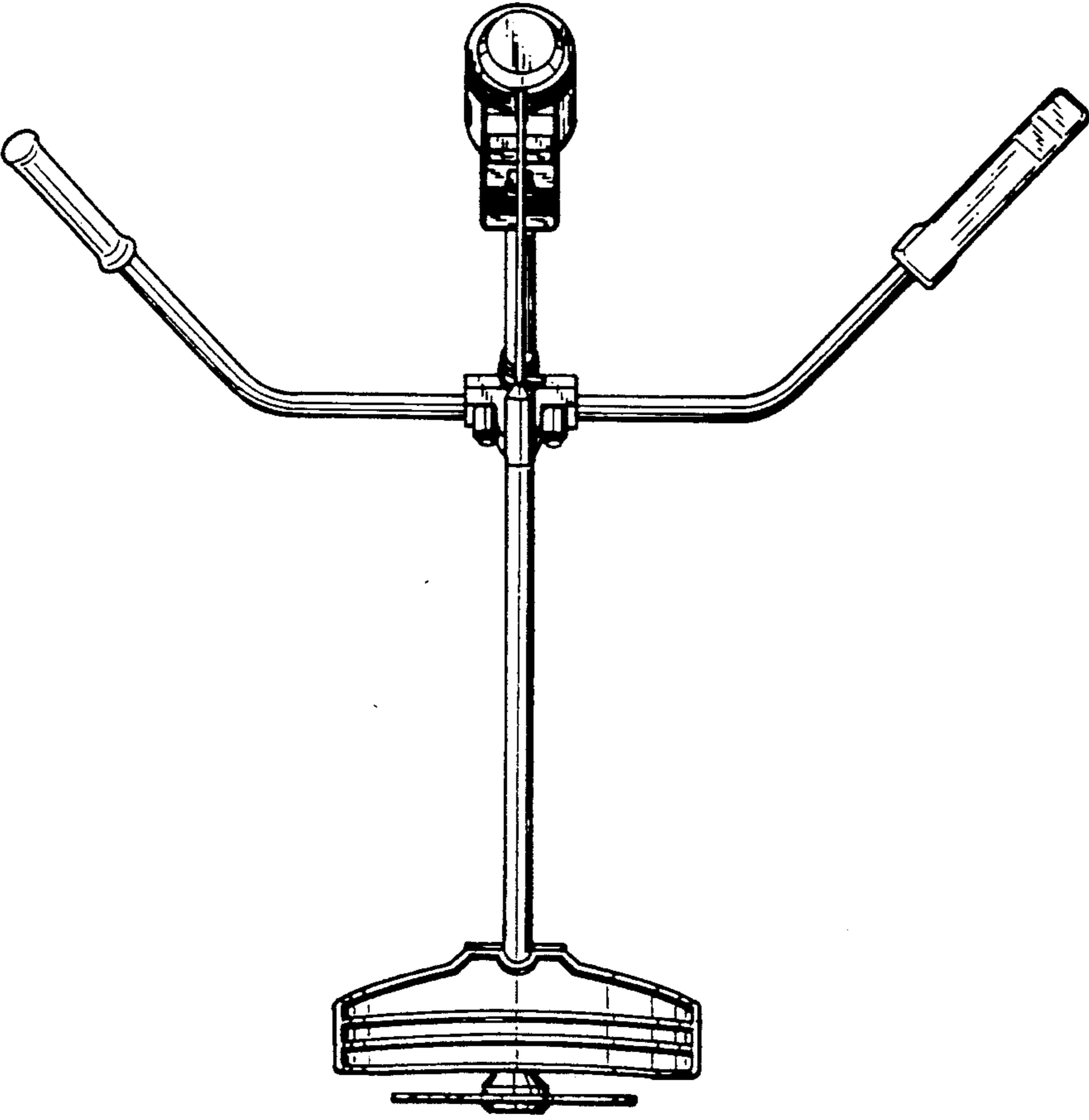

Fig. 6

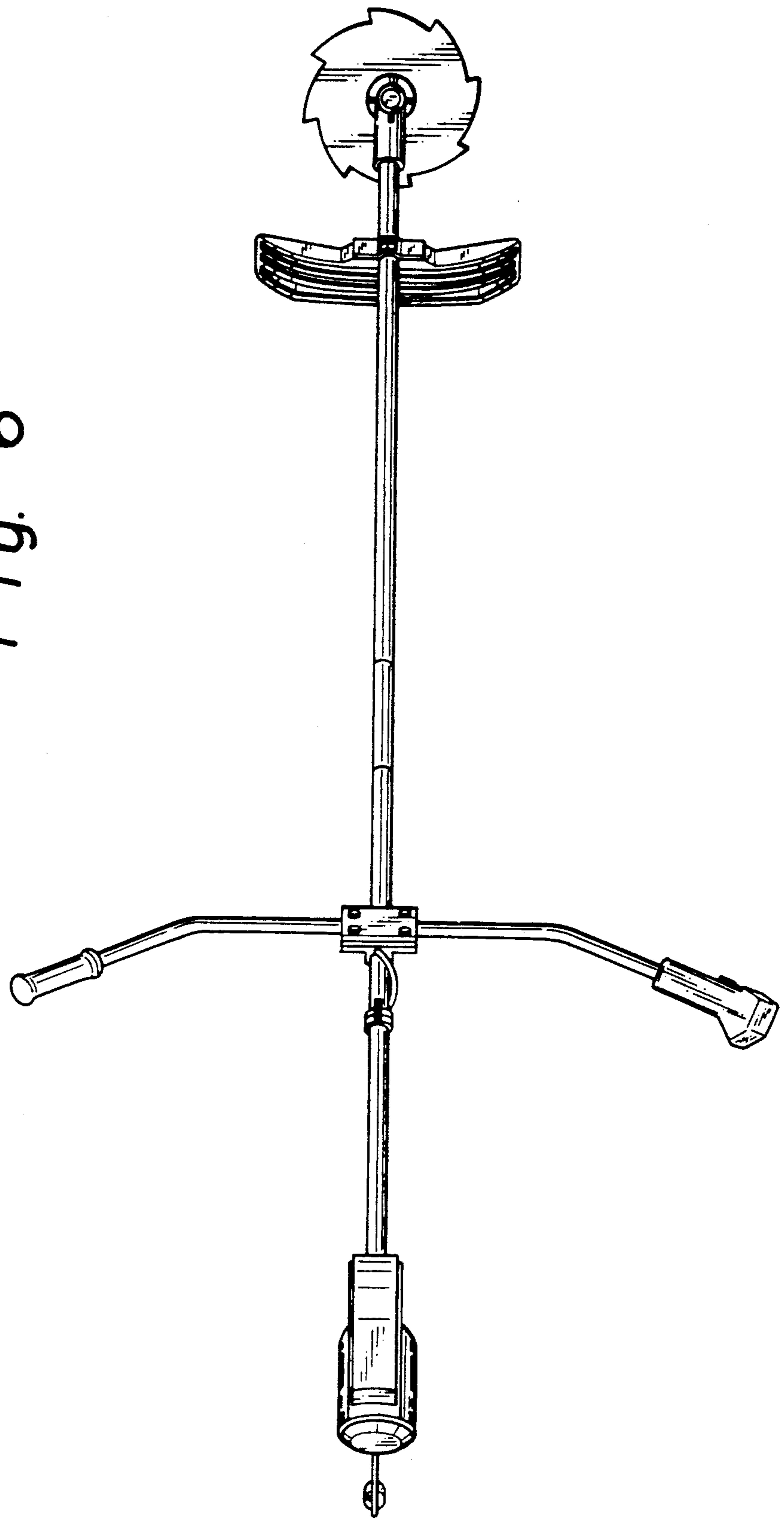

Fig. 7

