



US00D342417S

# United States Patent [19]

McClellan

[11] Patent Number: **Des. 342,417**

[45] Date of Patent: **\*\* Dec. 21, 1993**

[54] SANDWICH TOASTER

[75] Inventor: **John W. McClellan**, Sydney, Australia

[73] Assignee: **Breville R & D Pty Limited**, Pyrmont

[\*\*] Term: **14 Years**

[21] Appl. No.: **704,630**

[22] Filed: **May 23, 1991**

[52] U.S. Cl. .... **D7/352; D7/328**

[58] Field of Search ..... **D7/323, 328-330, D7/352, 353; 99/372, 374, 376, 377, 379; 219/524, 525**

D. 274,113 6/1984 Steinkamp ..... D7/352

*Primary Examiner*—Alan P. Douglas  
*Assistant Examiner*—Caron D. Veynar  
*Attorney, Agent, or Firm*—Nixon & Vanderhye

### [57] CLAIM

The ornamental design for the sandwich toaster, as shown and described.

### DESCRIPTION

FIG. 1 is a front perspective view of a sandwich toaster showing my new design;

FIG. 2 is a top plan view thereof, the broken lines showing the heater elements being environmental only and forming no part of the claimed design;

FIG. 3 is a plan view thereof from below;

FIG. 4 is a front elevational view thereof;

FIG. 5 is a rear elevational view thereof;

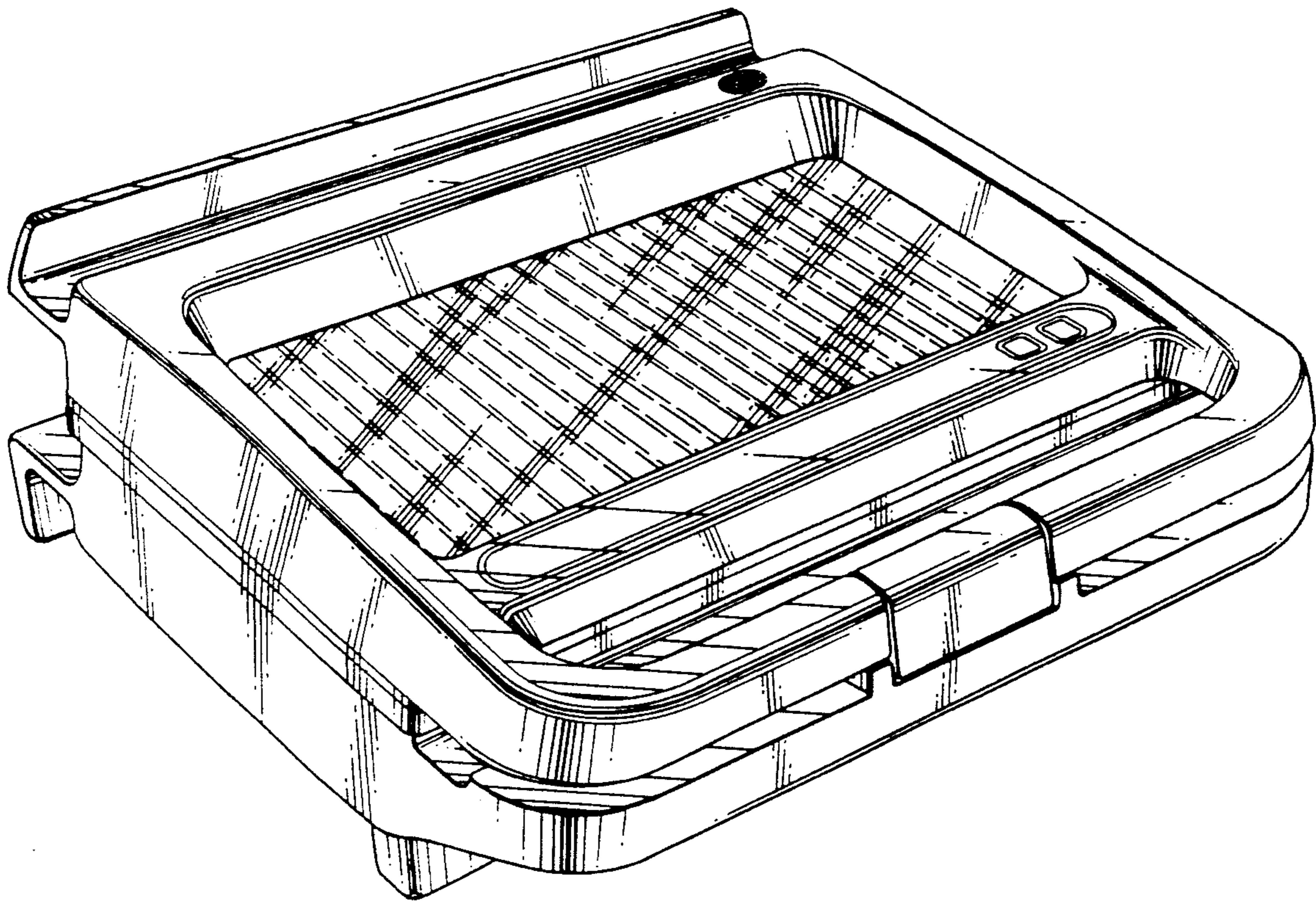
FIG. 6 is a left side elevational view thereof; and,

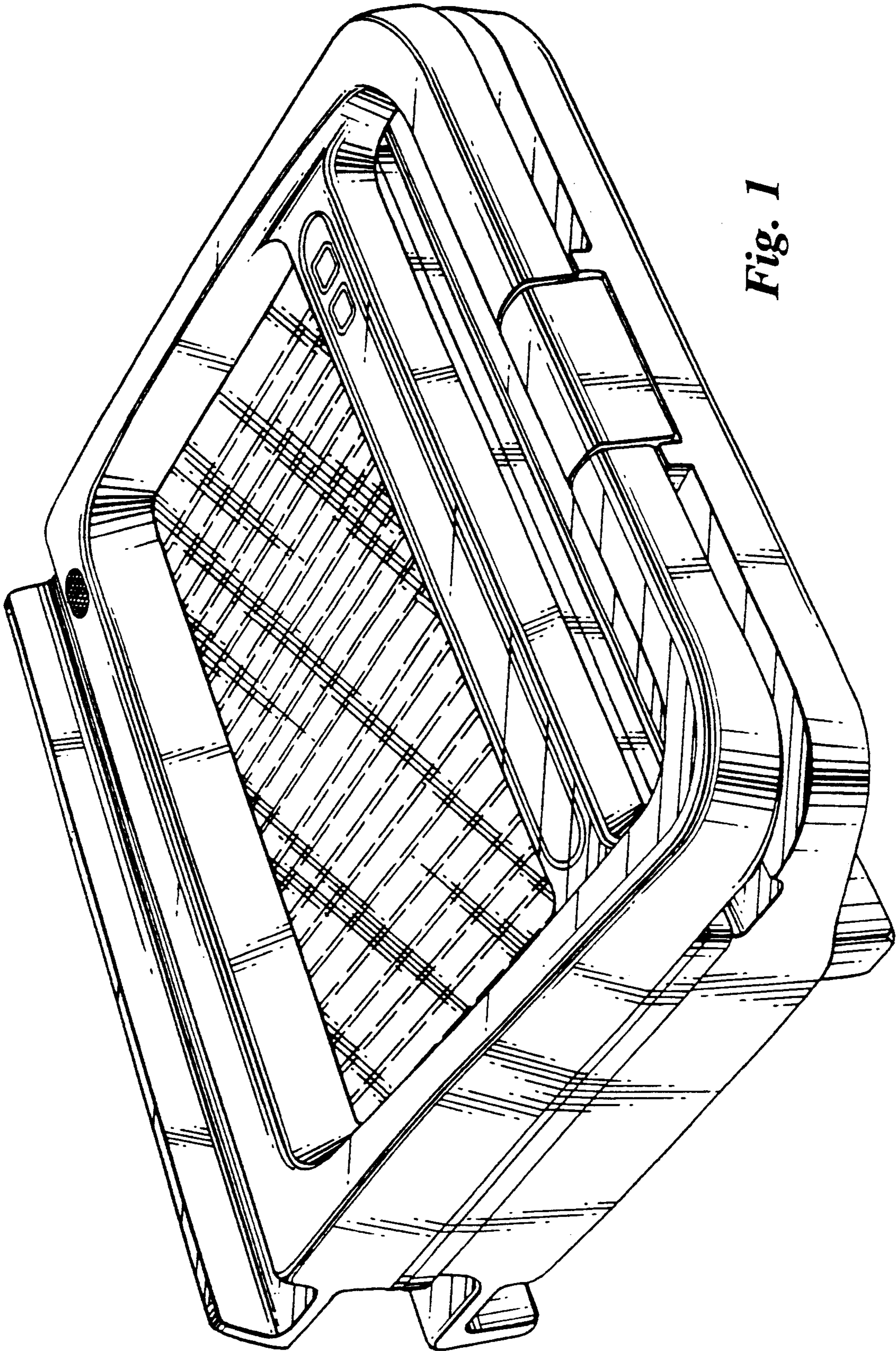
FIG. 7 is a right side elevational view thereof.

### [56] References Cited

#### U.S. PATENT DOCUMENTS

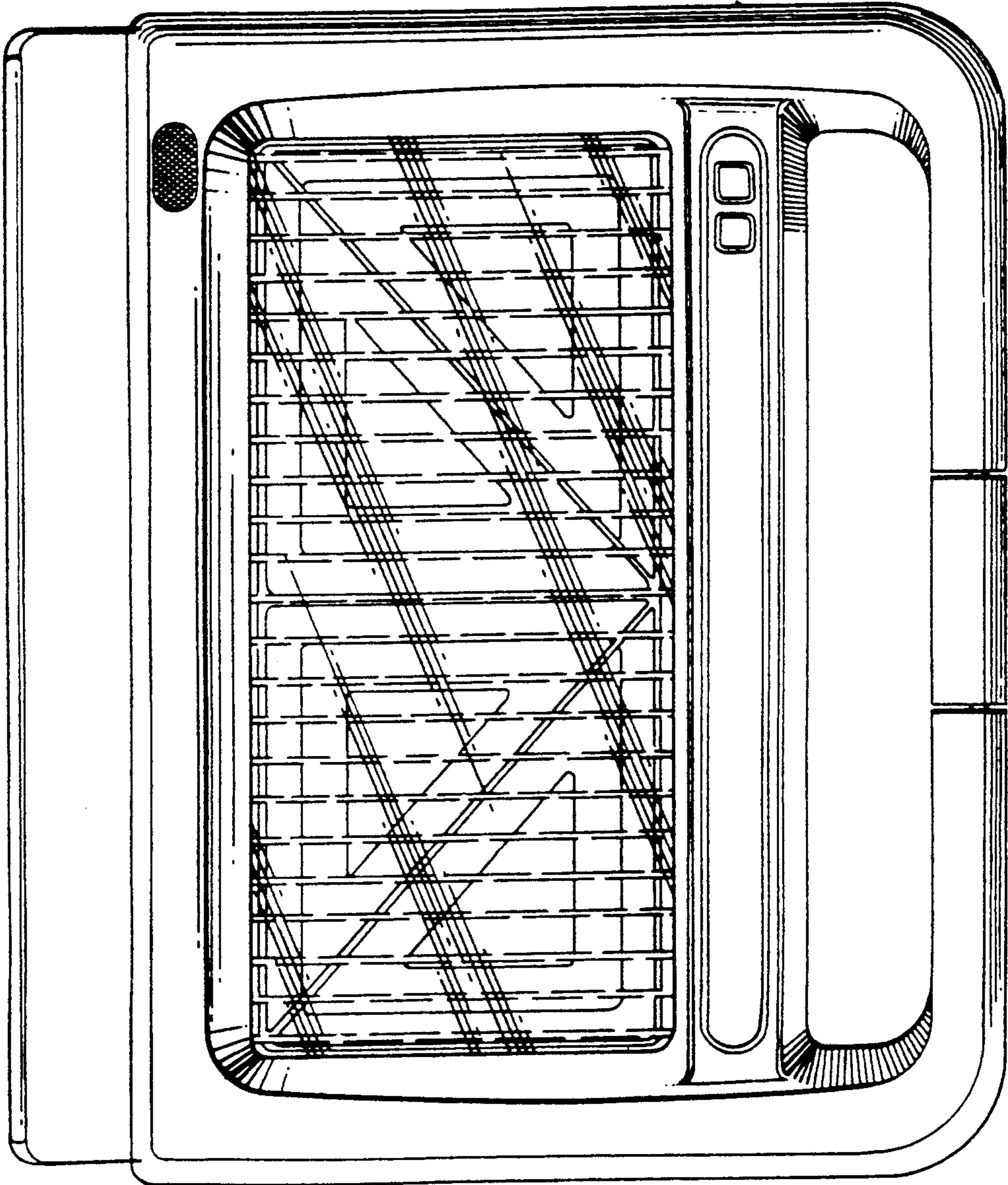
|            |        |          |       |        |
|------------|--------|----------|-------|--------|
| D. 152,321 | 1/1949 | Cavanagh | ..... | D7/352 |
| D. 213,931 | 4/1969 | Bardeau  | ..... | D7/352 |
| D. 232,012 | 7/1974 | Bardeau  | ..... | D7/352 |
| D. 266,306 | 9/1982 | Ansel    | ..... | D7/352 |



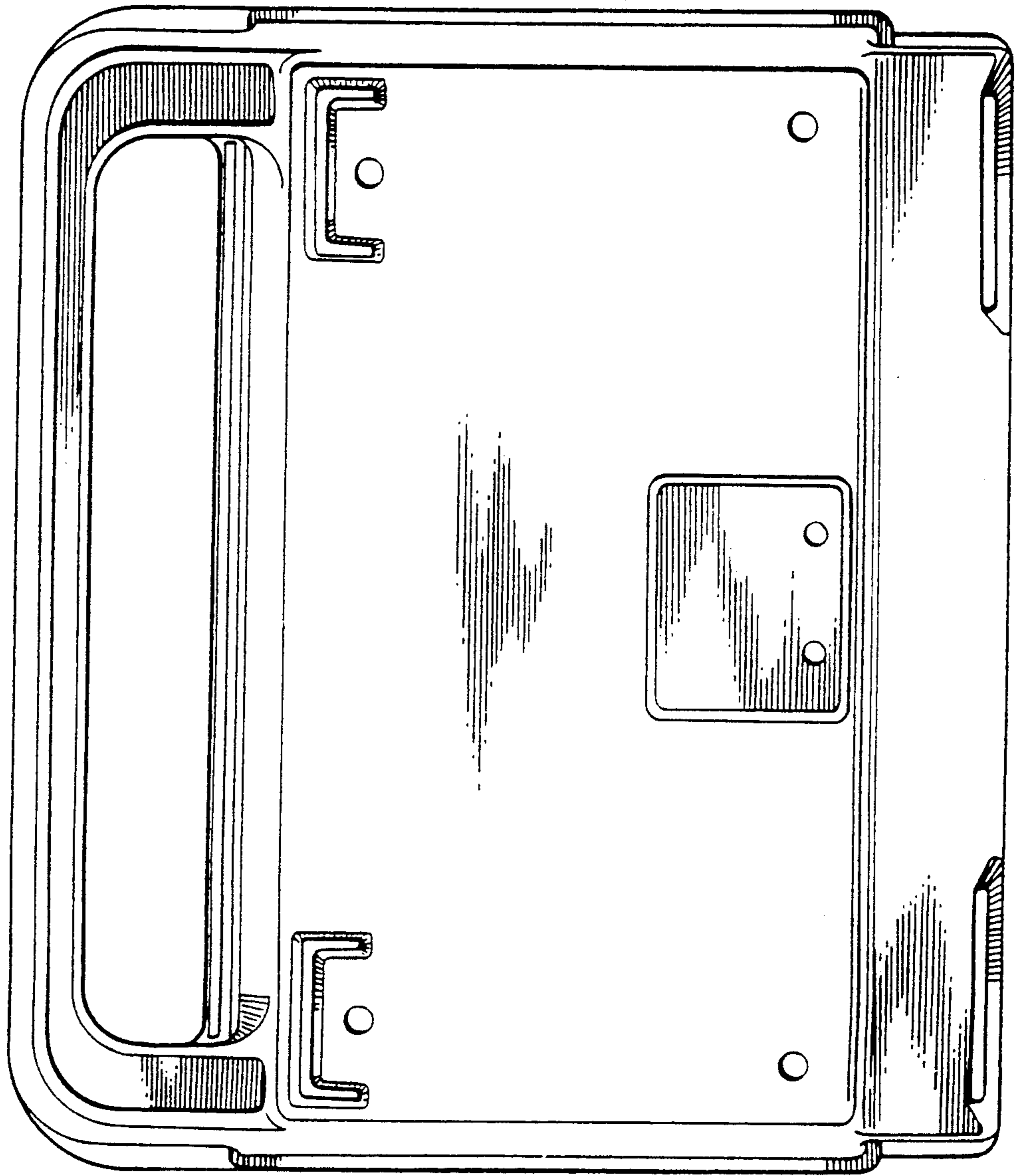


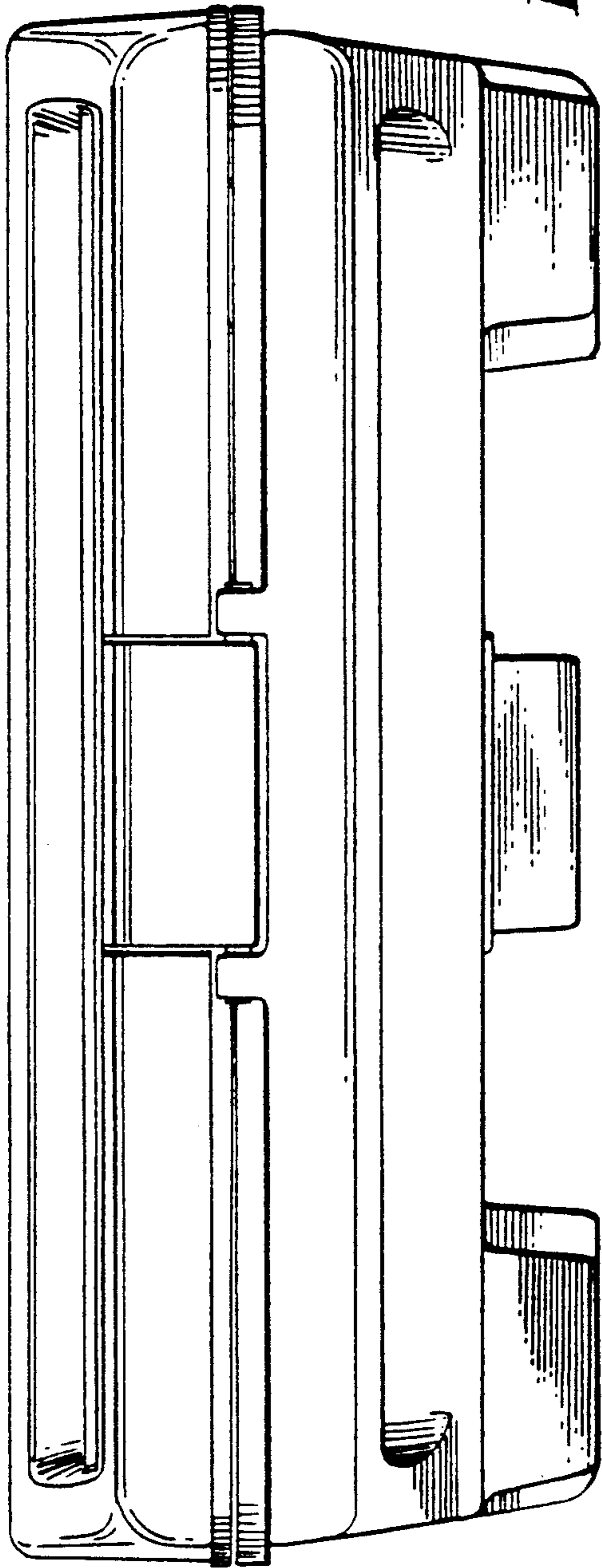
*Fig. 1*

*Fig. 2*

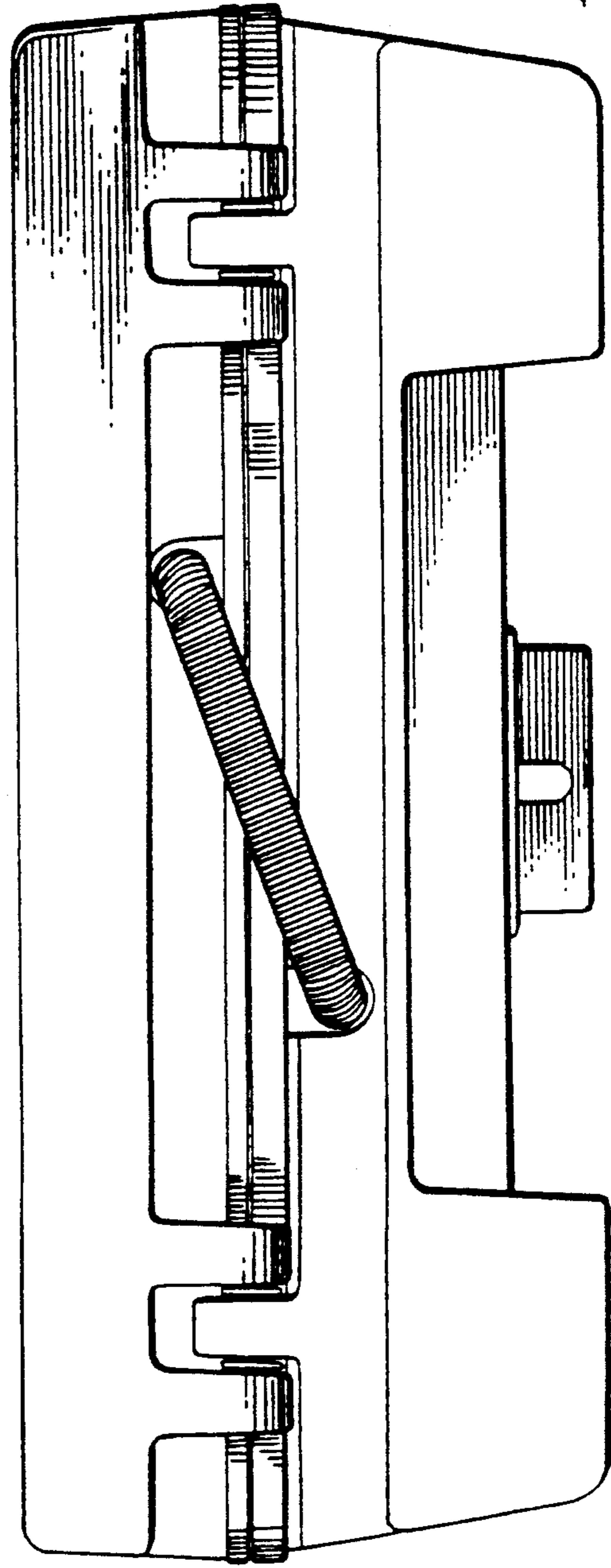


*Fig. 3*

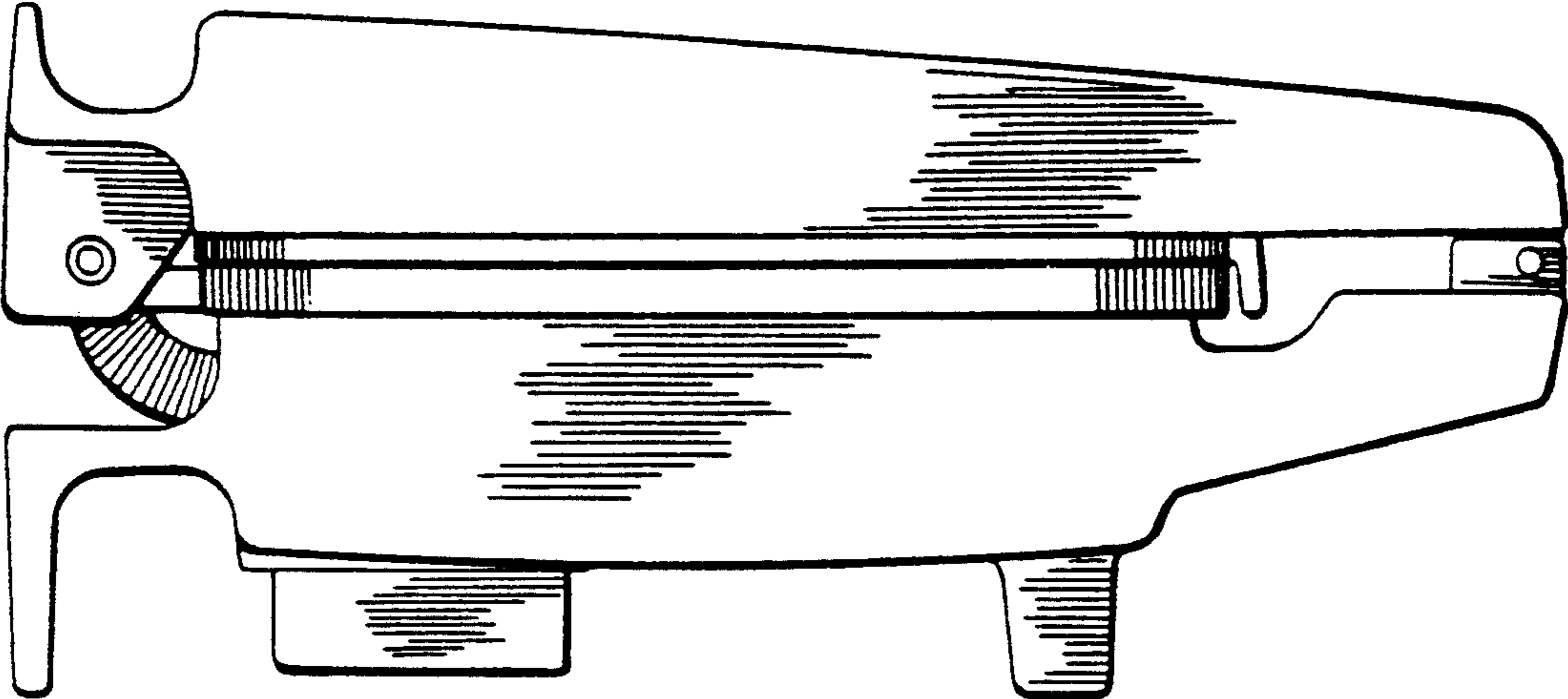




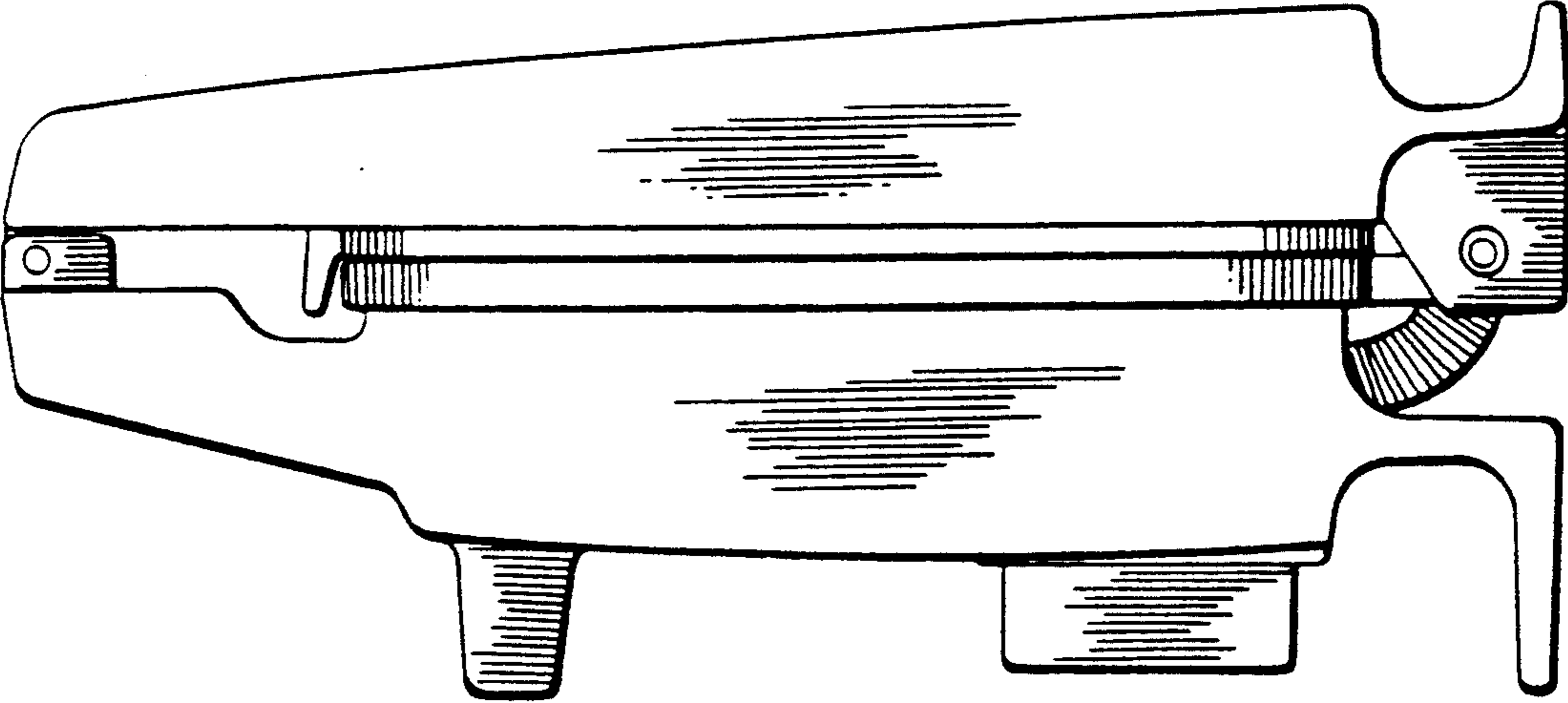
*Fig. 4*



*Fig. 5*



*Fig. 6*



*Fig. 7*