



US00D342340S

United States Patent [19]

[11] Patent Number: Des. 342,340

Greenfield et al.

[45] Date of Patent: ** Dec. 14, 1993

[54] ASHTRAY

[76] Inventors: Rick R. Greenfield, Rte. #1 Box 271;
Ronald B. Herriman, Rte. #1 Box
272, both of South Coffeyville, Okla.
74072

[**] Term: 14 Years

[21] Appl. No.: 834,710

[22] Filed: Feb. 12, 1992

[52] U.S. Cl. D27/120; D27/106

[58] Field of Search D27/106, 120; 131/231,
131/240.1

[56] **References Cited**

U.S. PATENT DOCUMENTS

- D. 68,922 12/1925 Kuzaroff D27/120 X
- D. 164,497 9/1951 Hoehn D27/120
- D. 166,272 3/1952 Perlongo D27/120

Primary Examiner—Wallace R. Burke
Assistant Examiner—H. Baynham
Attorney, Agent, or Firm—Hugh E. Smith

[57] **CLAIM**

The ornamental design for an ashtray, as shown and described.

DESCRIPTION

FIG. 1 is a top plan view of an ashtray showing our new design;
FIG. 2 is a bottom plan view thereof;
FIG. 3 is a left side elevational view thereof;
FIG. 4 is a right side elevational view thereof;
FIG. 5 is a rear elevational view thereof;
FIG. 6 is a front elevational view thereof; and,
FIG. 7 is an isometric view thereof.

The broken line showing of "Team Logo" is for illustrative purposes only and forms no part of the claimed design.

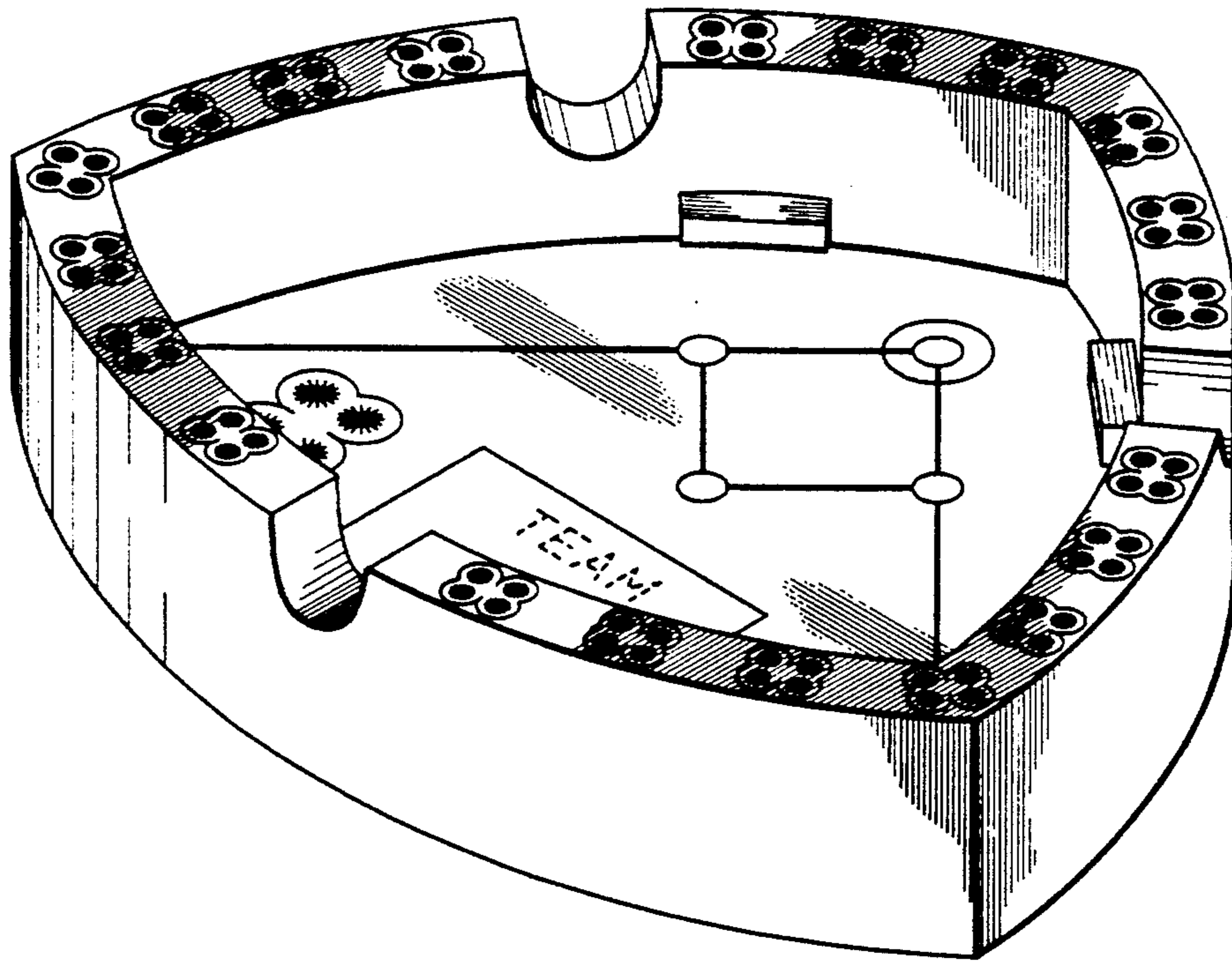

FIG. 1

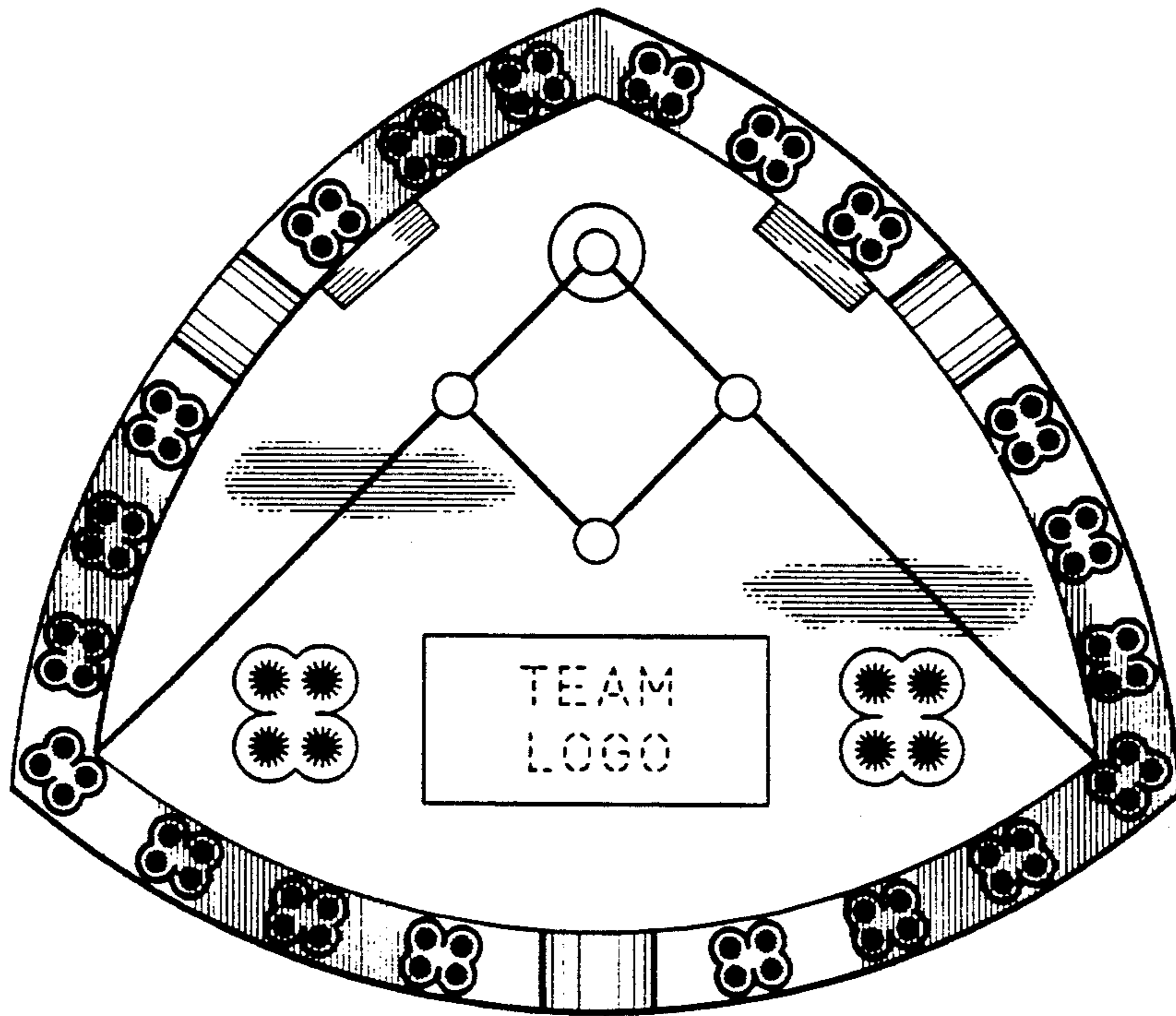

FIG. 2

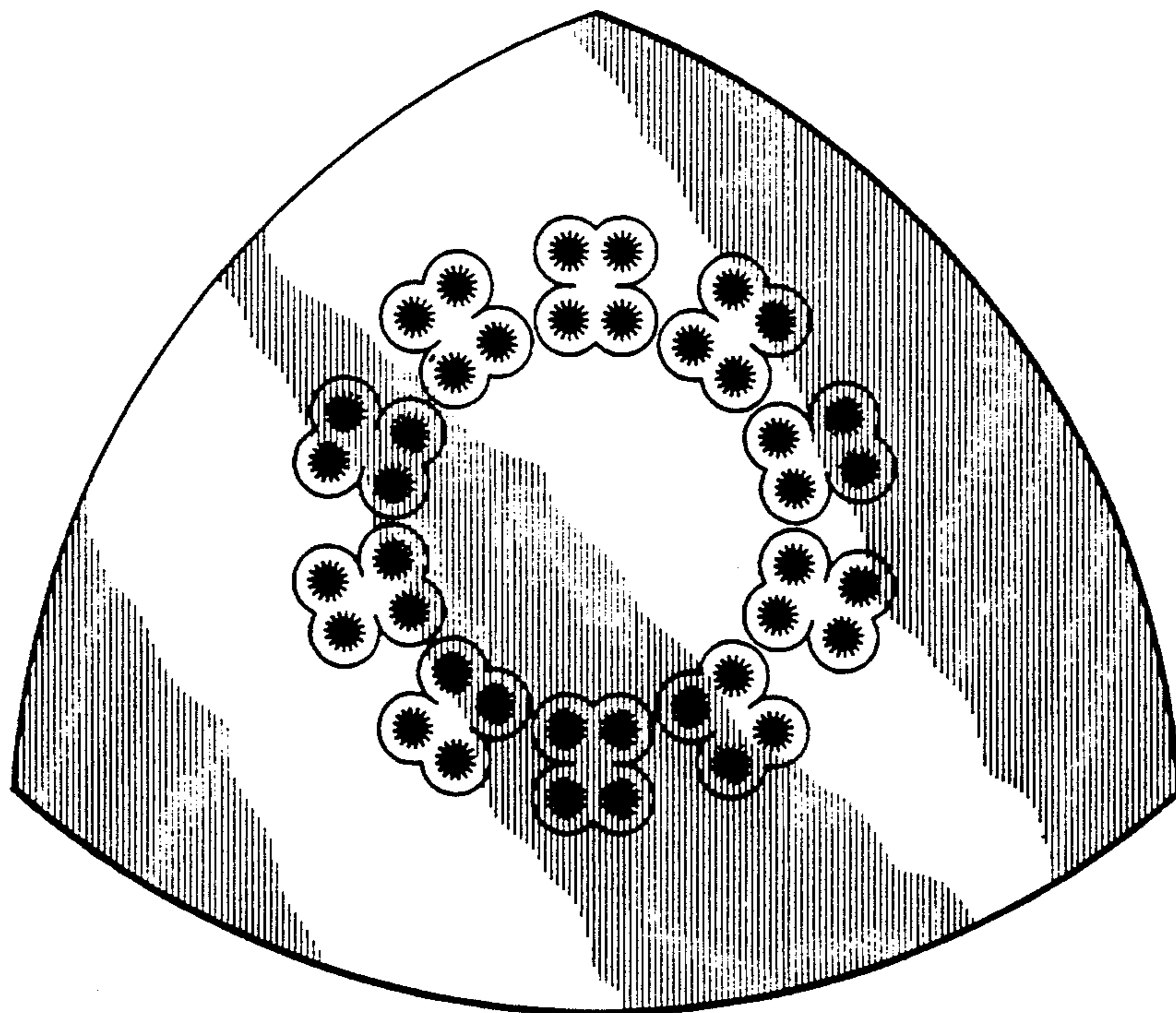

FIG. 3

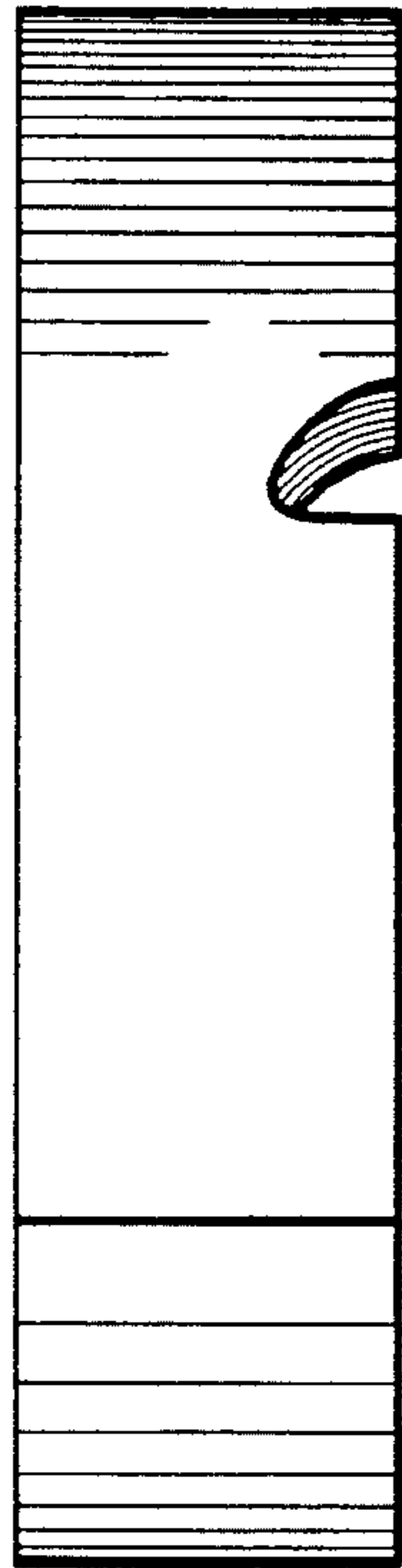

FIG. 4

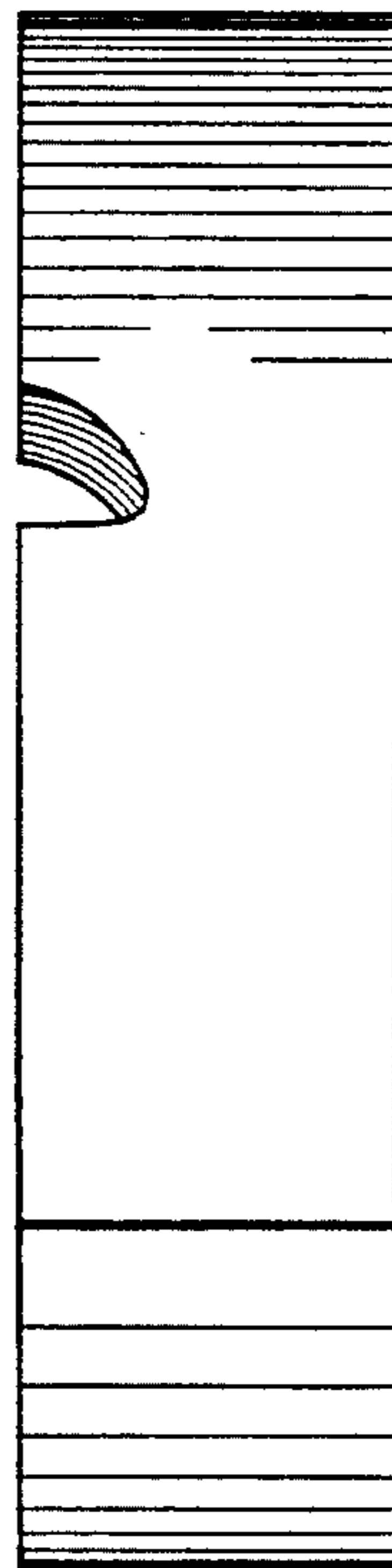

FIG. 5

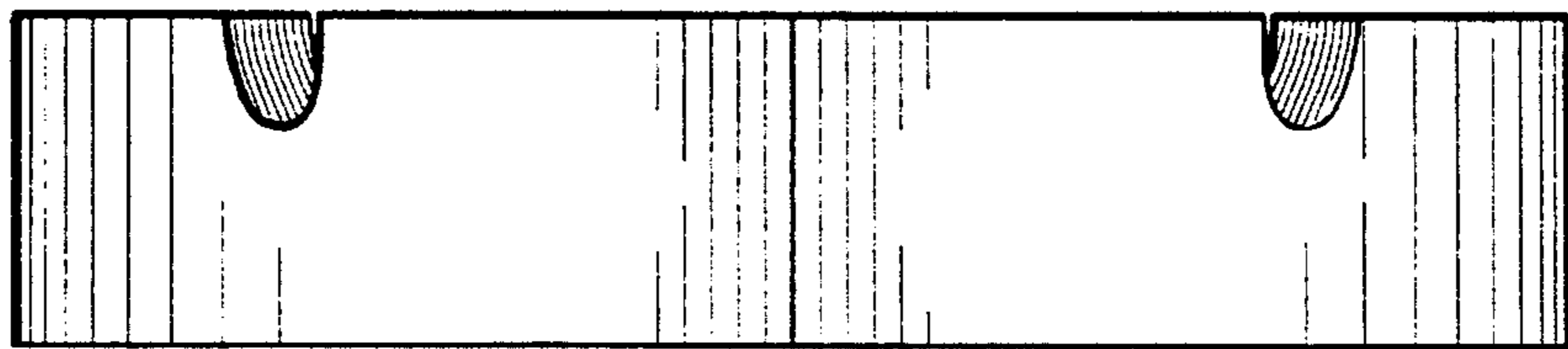

FIG. 6

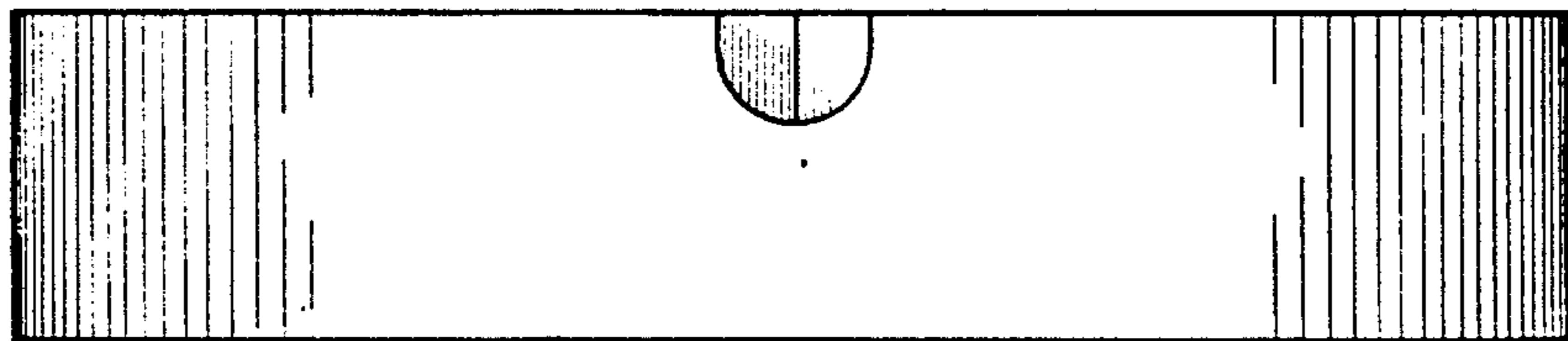

FIG. 7

