



US00D341941S

United States Patent [19]

Stokes

[11] Patent Number: **Des. 341,941**

[45] Date of Patent: **** Dec. 7, 1993**

[54] PAINT DISPENSING APPLICATOR

[76] Inventor: **Virginia Stokes, P.O. Box M-580,
Gary, Ind. 46401**

[**] Term: **14 Years**

[21] Appl. No.: **664,951**

[22] Filed: **Mar. 5, 1991**

[52] U.S. Cl. **D4/114; D4/137;
D32/45**

[58] Field of Search **D4/114, 121, 132, 135,
D4/137-138; D32/40, 42, 45; 15/104.92;
401/16, 23-27, 136-139, 150, 196, 207**

[56] References Cited

U.S. PATENT DOCUMENTS

416,659	12/1889	Wells et al.	15/209.1 X
2,002,598	5/1935	Wood, Jr.	401/207
2,388,321	11/1945	Gereke	401/150 X
3,372,975	3/1968	Johnson	401/207 X

FOREIGN PATENT DOCUMENTS

1075047 10/1954 France 401/207

Primary Examiner—Wallace R. Burke
Assistant Examiner—Lavone D. Tabor
Attorney, Agent, or Firm—S. Michael Bender

[57] CLAIM

The ornamental design for a paint dispensing applicator, as shown and described.

DESCRIPTION

FIG. 1 is a front elevational view of the paint dispensing applicator showing my new design;
FIG. 2 is a rear elevational view thereof;
FIG. 3 is a greatly enlarged left side elevational view thereof;
FIG. 4 is a right side elevational view thereof;
FIG. 5 is a top plan view thereof as shown in FIG. 1;
FIG. 6 is a bottom plan view thereof; and,
FIG. 7 is an enlarged perspective view thereof.

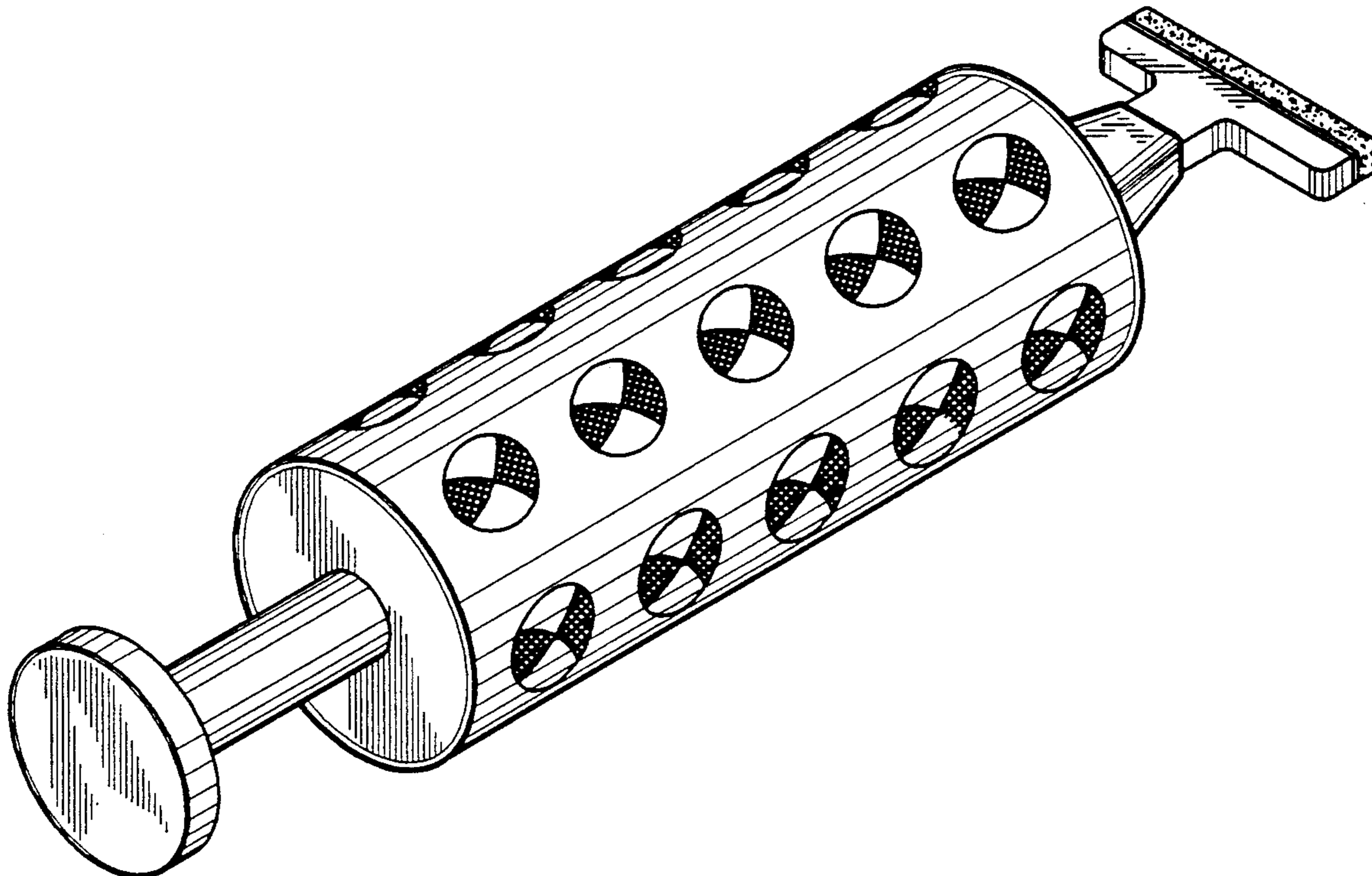

FIG. 1

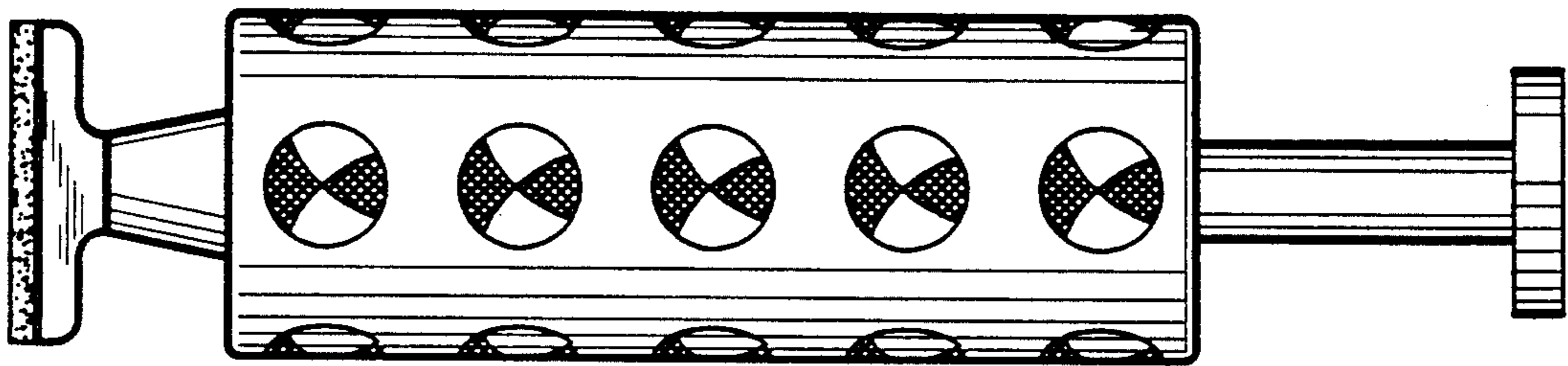

FIG. 2

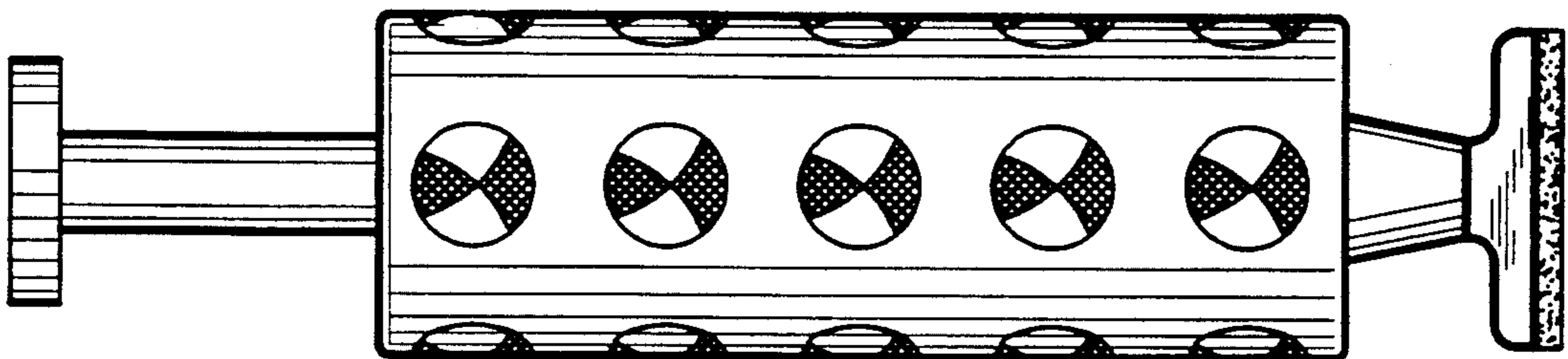

FIG. 3

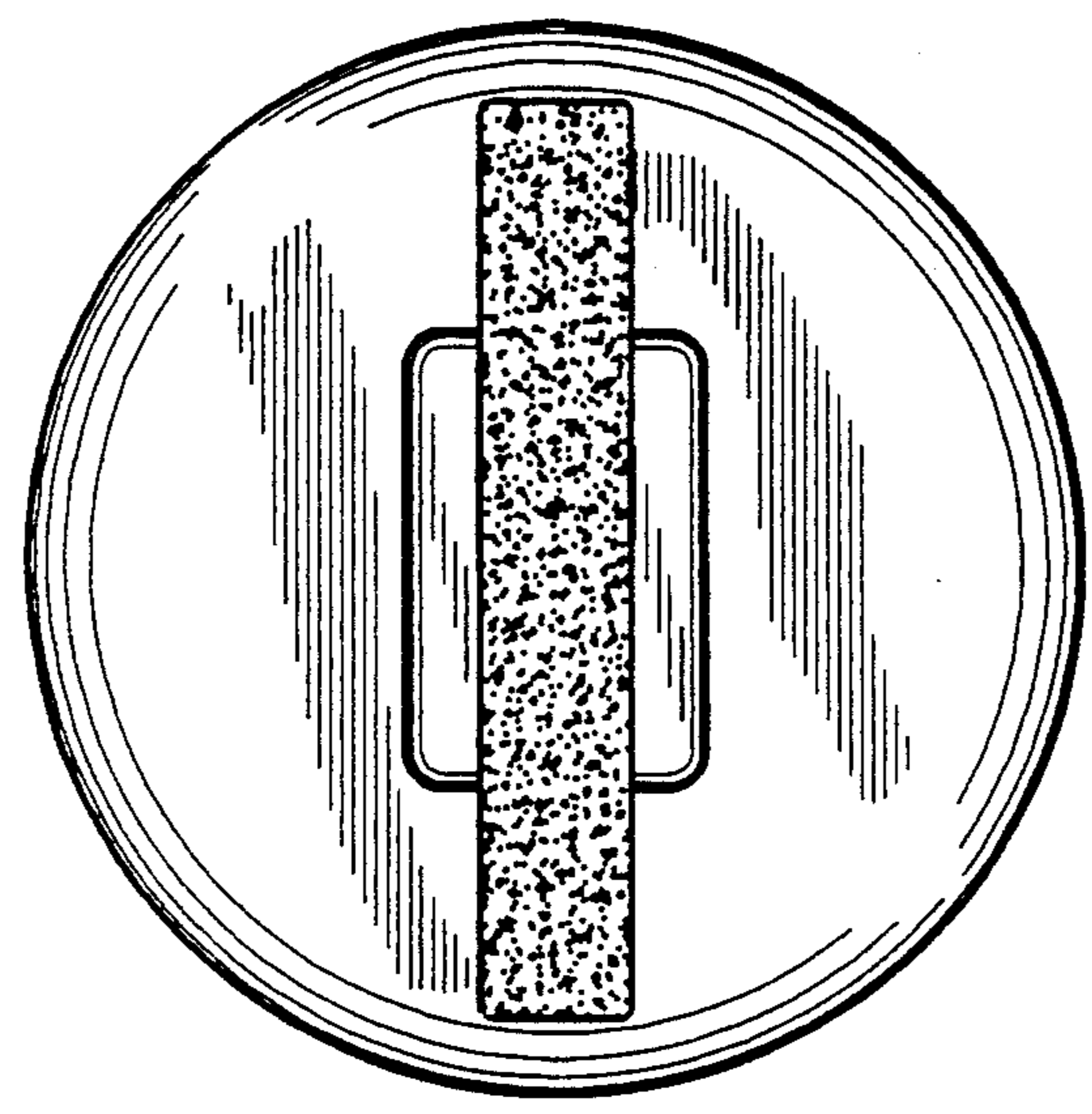

FIG. 4

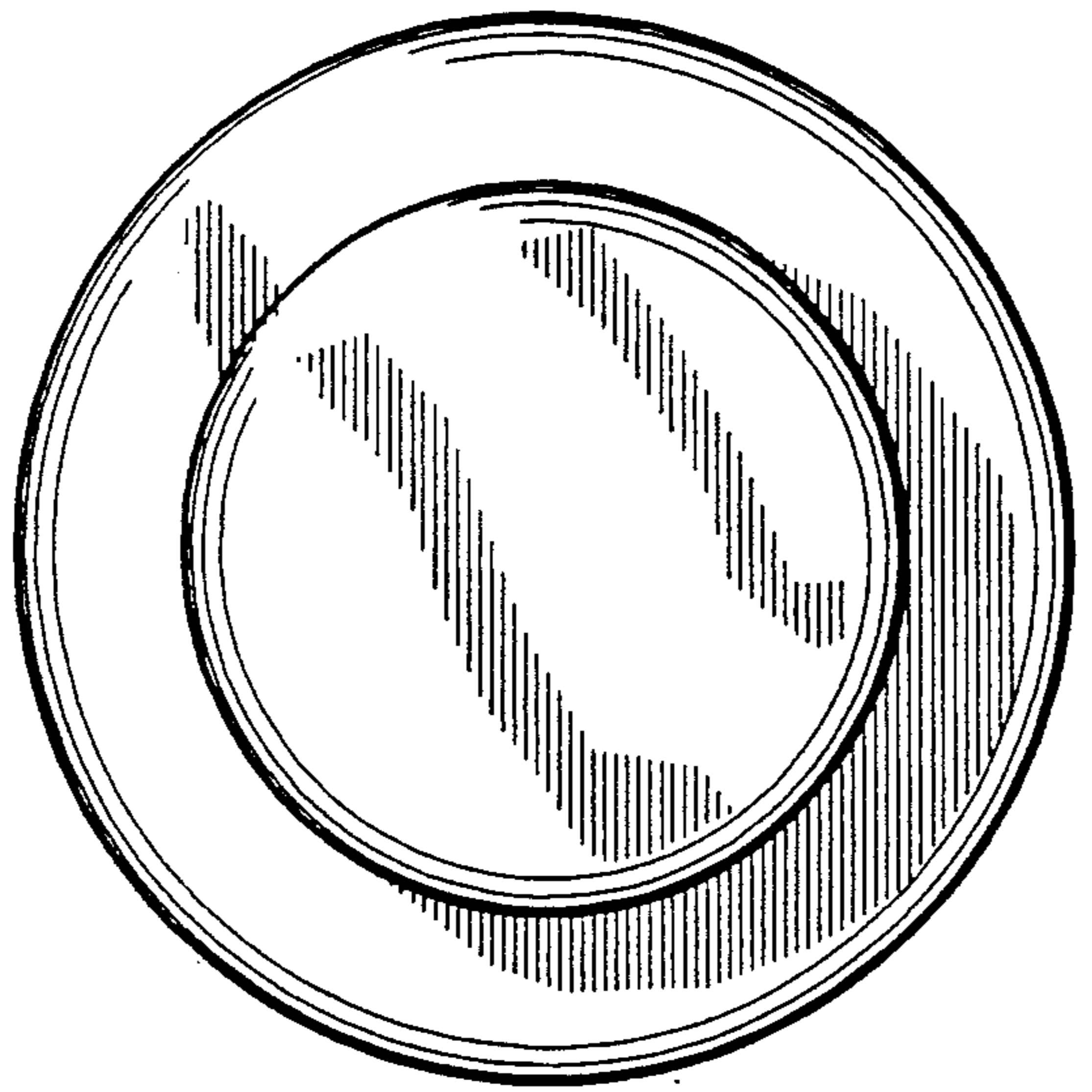

FIG. 5

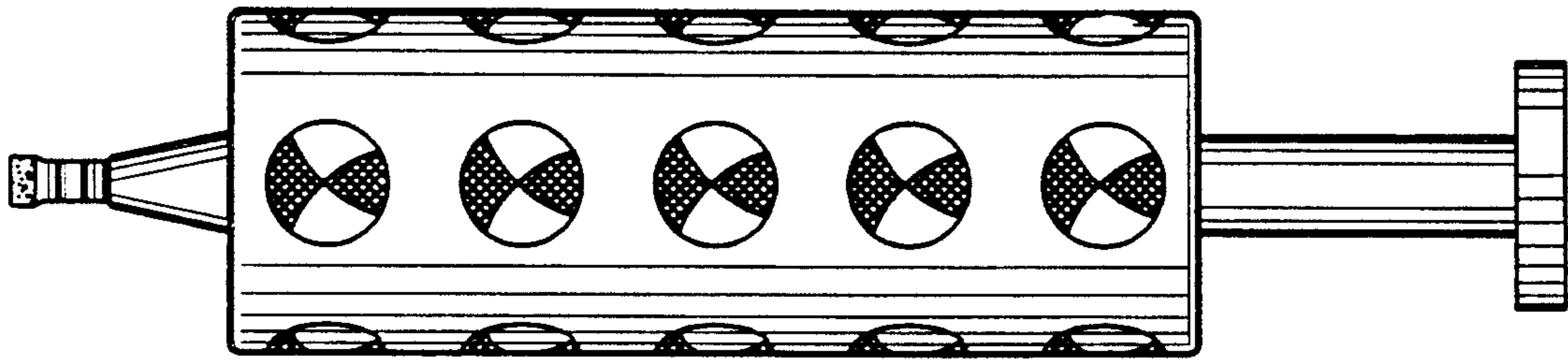

FIG. 6

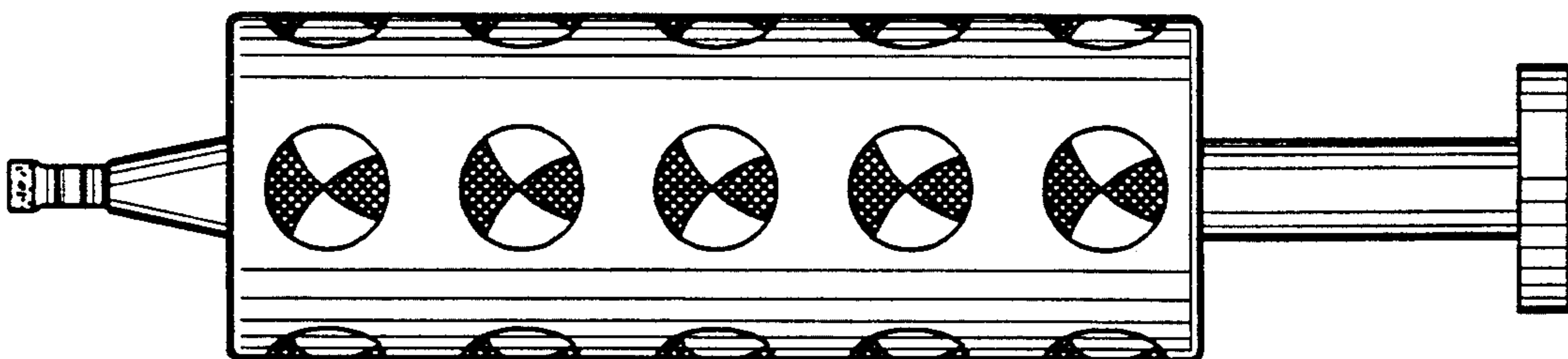

FIG. 7

