



US00D341917S

United States Patent [19]

[11] Patent Number: **Des. 341,917**

Meher

[45] Date of Patent: **** Nov. 30, 1993**

[54] MAIL CALL UNIT

[76] Inventor: **Lewis E. Meher**, 291 NW. Ferris Dr.,
Port St. Lucie, Fla. 34983

[**] Term: **14 Years**

[21] Appl. No.: **631,050**

[22] Filed: **Dec. 20, 1990**

[52] U.S. Cl. **D99/29; D99/43**

[58] Field of Search 232/1, 17, 32, 34-39;
D99/29, 30, 31, 32

[56] **References Cited**

U.S. PATENT DOCUMENTS

- D. 260,319 8/1981 Kuntz, Jr. D99/29
- D. 278,469 4/1985 Ross D99/29
- D. 313,688 1/1991 La Fountain et al. D99/29

Primary Examiner—Alan P. Douglas
Assistant Examiner—J. H. Musgrove
Attorney, Agent, or Firm—Leon Gilden

[57] **CLAIM**

The ornamental design for a mail call unit, as shown and described.

DESCRIPTION

FIG. 1 is a front elevational view of the mail call unit showing my new design;
FIG. 2 is a rear elevational view thereof;
FIG. 3 is a left side elevational view thereof;
FIG. 4 is a right side elevational view thereof;
FIG. 5 is a top plan view thereof;
FIG. 6 is a bottom plan view thereof; and,
FIG. 7 is a perspective view thereof.
The broken line showing of mailbox is for illustrative purposes only and forms no part of the claimed design.

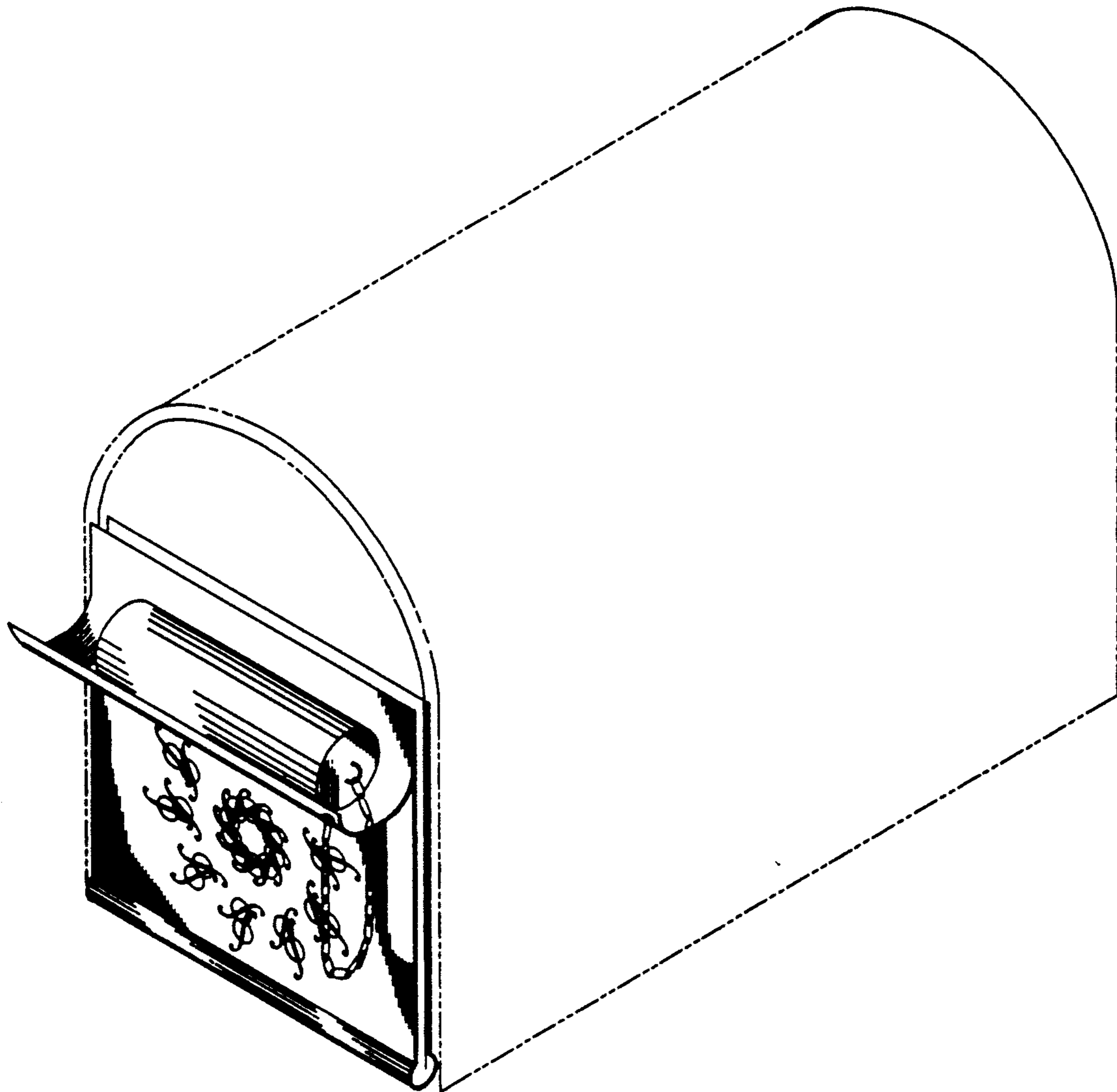

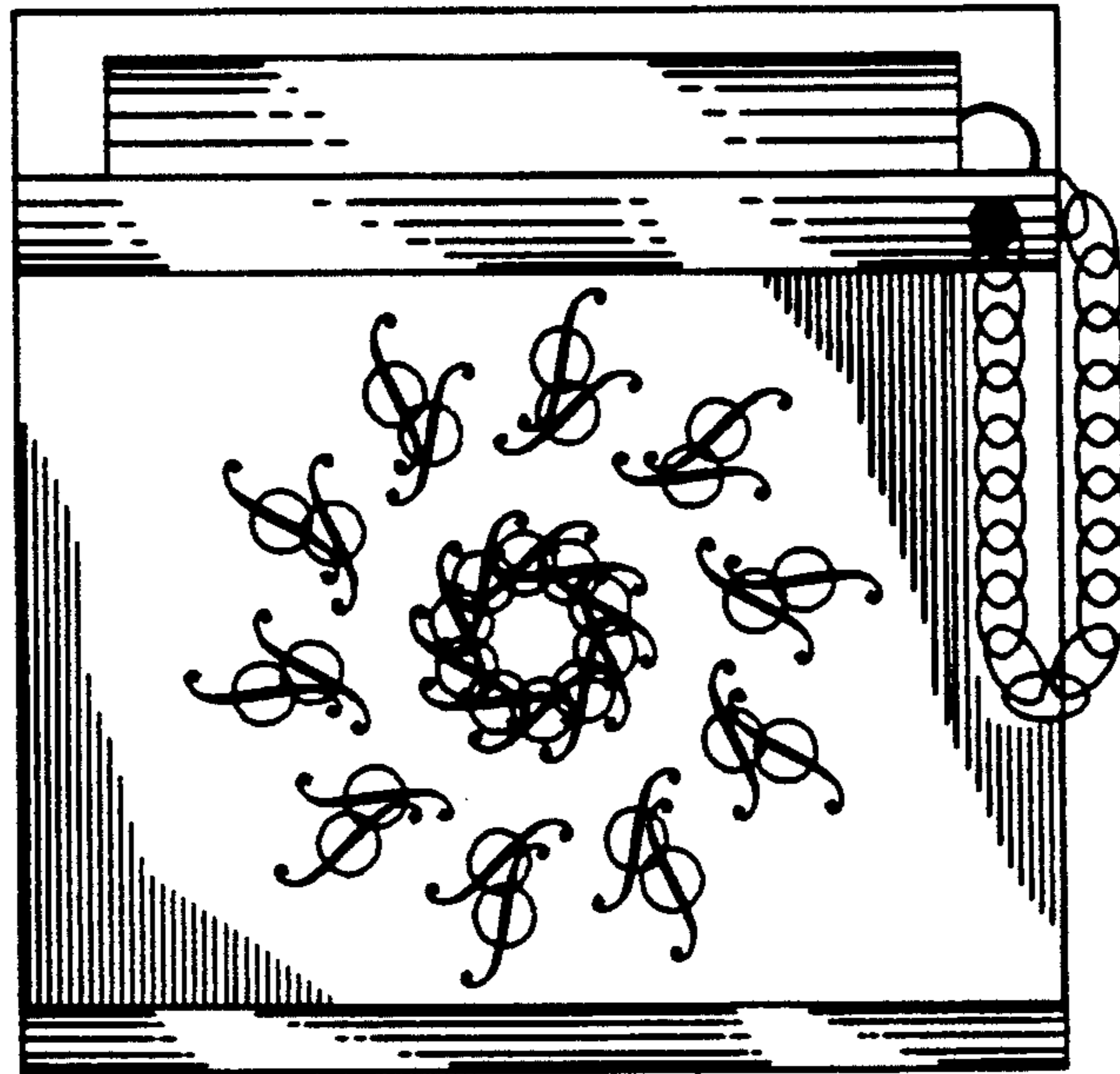

FIG. 1

FIG. 2

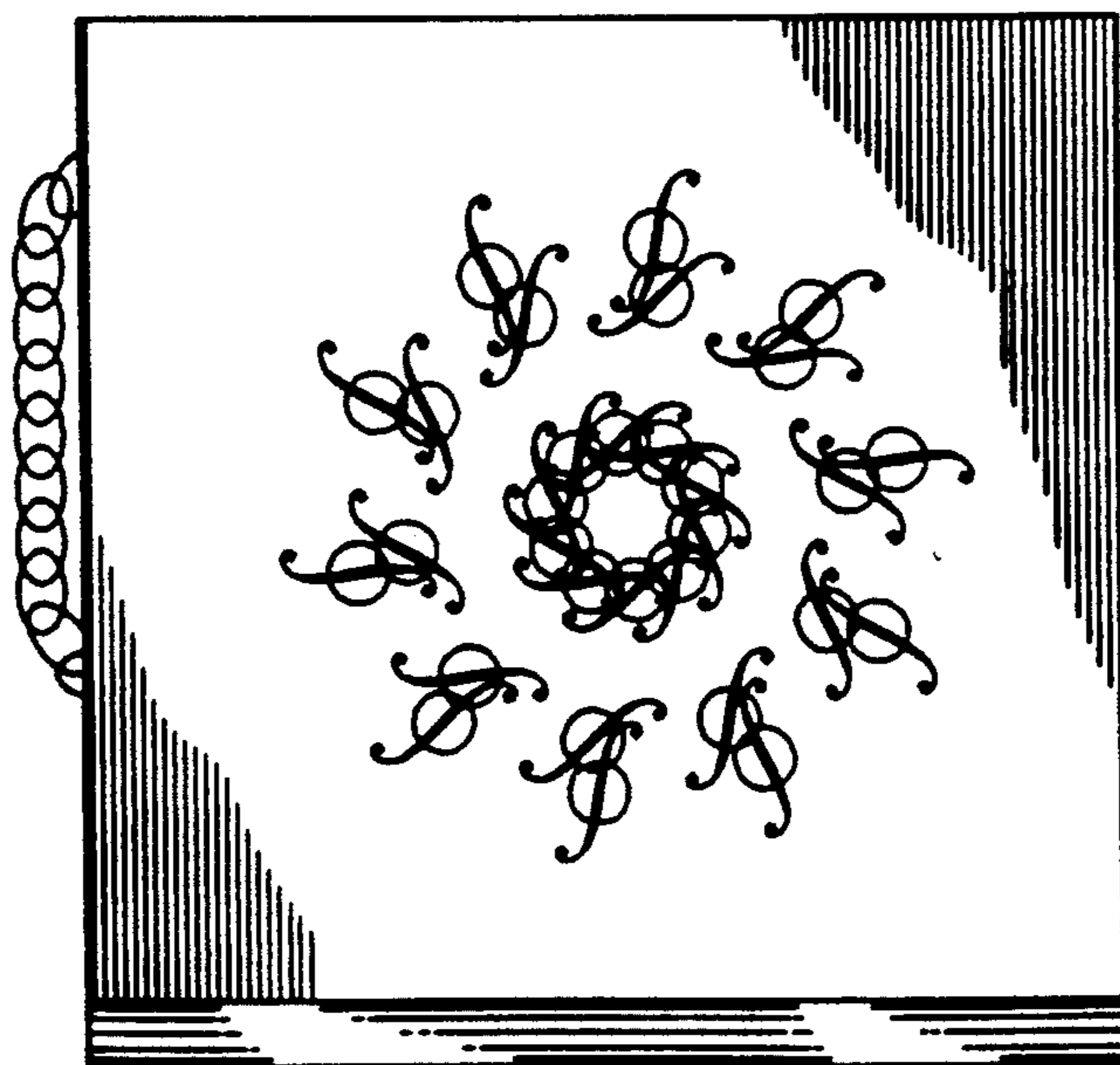

FIG. 3

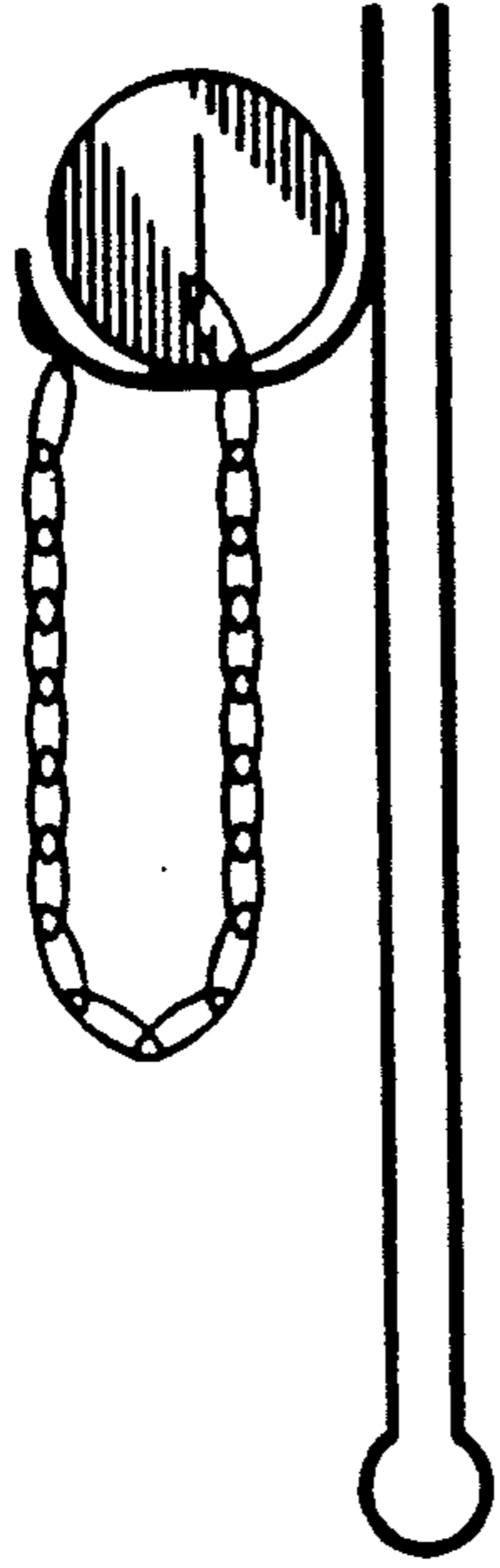

FIG. 4

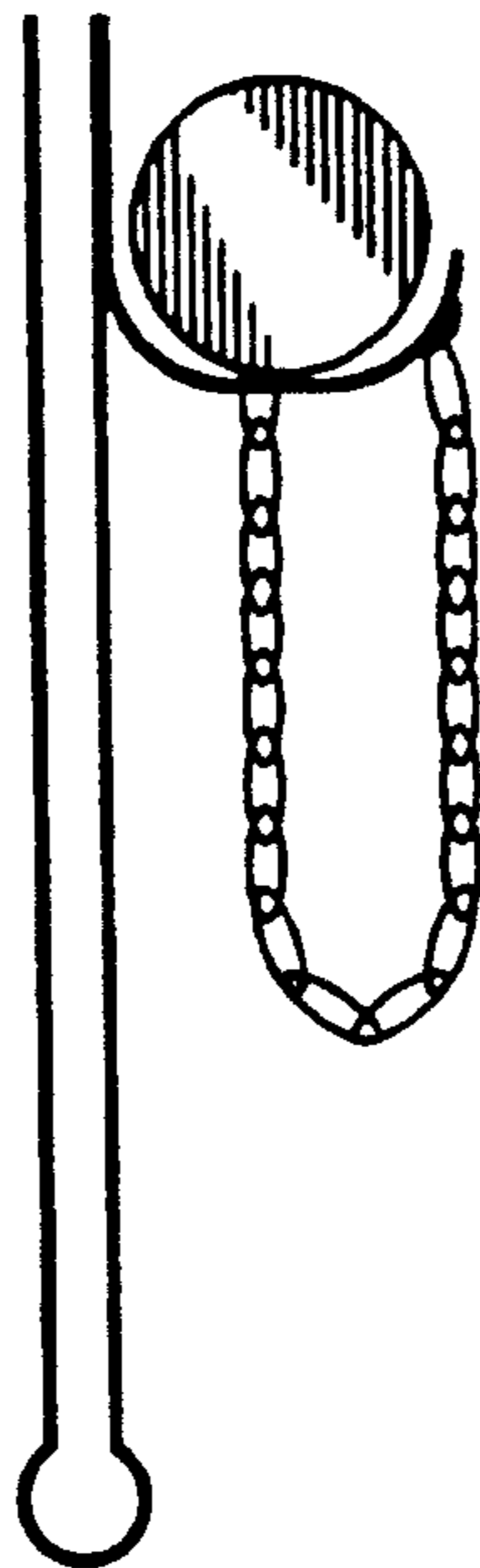

FIG. 5

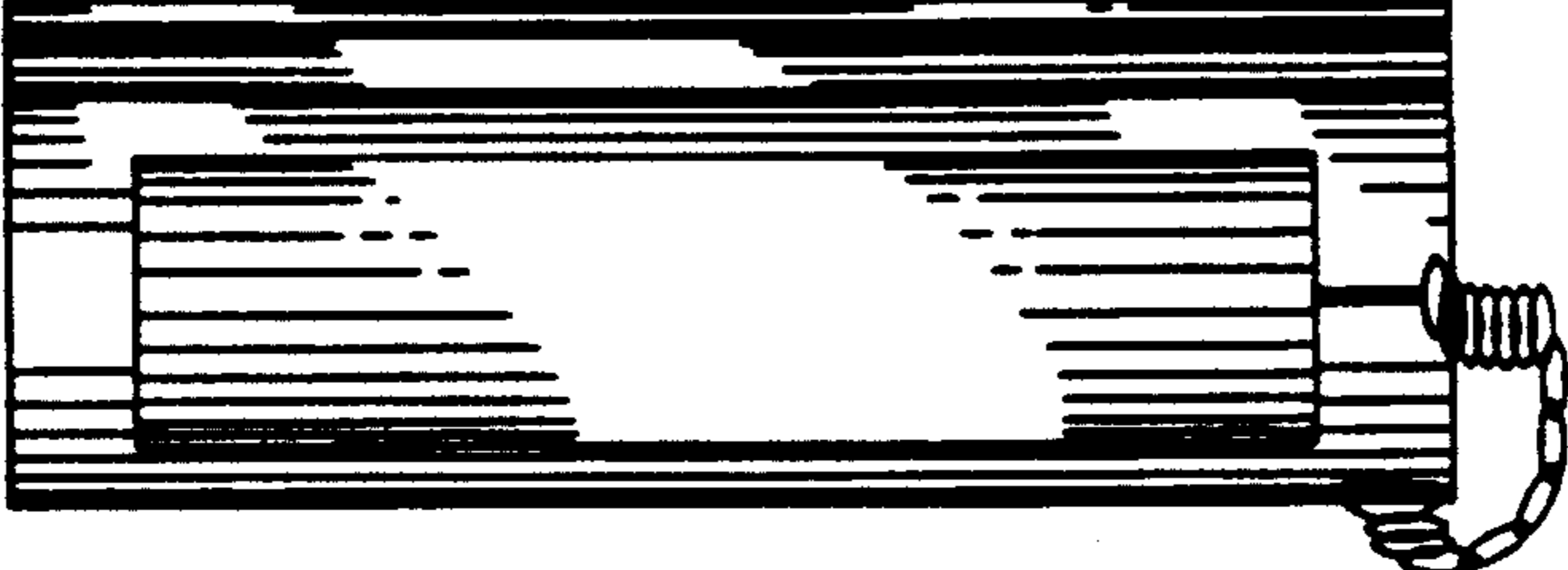

FIG. 6

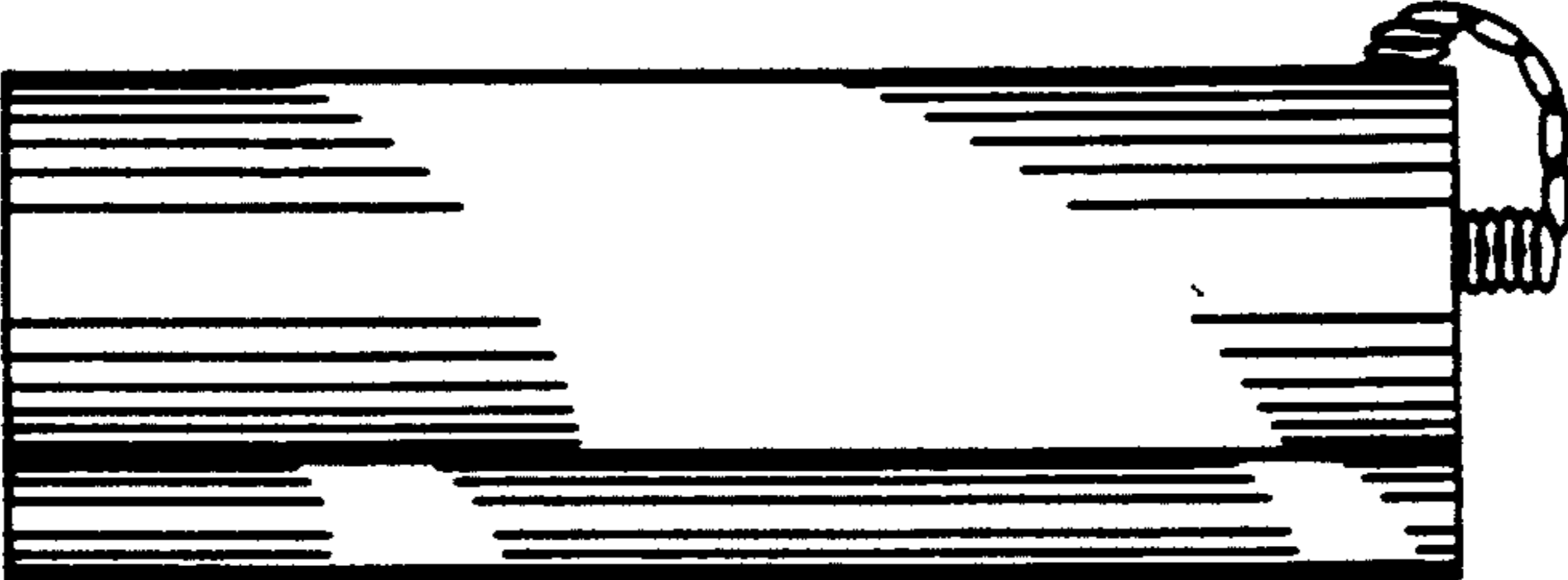

FIG. 7

