



US00D341849S

United States Patent [19]

[11] Patent Number: Des. 341,849

Hiroki

[45] Date of Patent: ** Nov. 30, 1993

[54] PAPER FEEDER FOR COPYING MACHINE

[75] Inventor: Shin-ichi Hiroki, Tokyo, Japan

[73] Assignee: Kabushiki Kaisha Toshiba, Kawasaki, Japan

[**] Term: 14 Years

[21] Appl. No.: 668,464

[22] Filed: Mar. 13, 1991

[30] Foreign Application Priority Data

Sep. 17, 1990 [JP] Japan 2-30910

[52] U.S. Cl. D18/49

[58] Field of Search D18/44, 46, 47, 48, D18/49; 400/613, 619, 624-625, 629, 691; 226/74, 196; 355/308, 309, 321, 324; 271/145, 162-164; 312/208; 211/50

[56] References Cited

U.S. PATENT DOCUMENTS

D. 286,410 10/1986 Hara D18/49
D. 321,712 11/1991 Tsutsui D18/49
D. 330,385 10/1992 Umino D18/49

FOREIGN PATENT DOCUMENTS

745575 8/1989 Japan .
7455751 8/1989 Japan .

OTHER PUBLICATIONS

Minolta EP850.
Panasonic, Panacopy FP-5070.
Sharp SF-9550.

Primary Examiner—Alan P. Douglas
Assistant Examiner—Ann Hunt
Attorney, Agent, or Firm—Oblon, Spivak, McClelland, Maier & Neustadt

[57] CLAIM

The ornamental design for paper feeder for copying machine, as shown and described.

DESCRIPTION

FIG. 1 is a top, front and right side perspective view of paper feeder for copying machine showing my new design;

FIG. 2 is a front elevational view thereof;

FIG. 3 is a top plan view thereof;

FIG. 4 is a right side elevational view thereof;

FIG. 5 is a left side elevational view thereof;

FIG. 6 is a rear elevational view thereof;

FIG. 7 is a bottom plan view thereof;

FIG. 8 is a cross-sectional view thereof taken on line 8-8 in FIG. 2; and

FIG. 9 is a top, front and left side perspective view thereof; the dotted line portion depicting a copying machine is shown for illustrative purpose only and forms no part of the claimed invention.

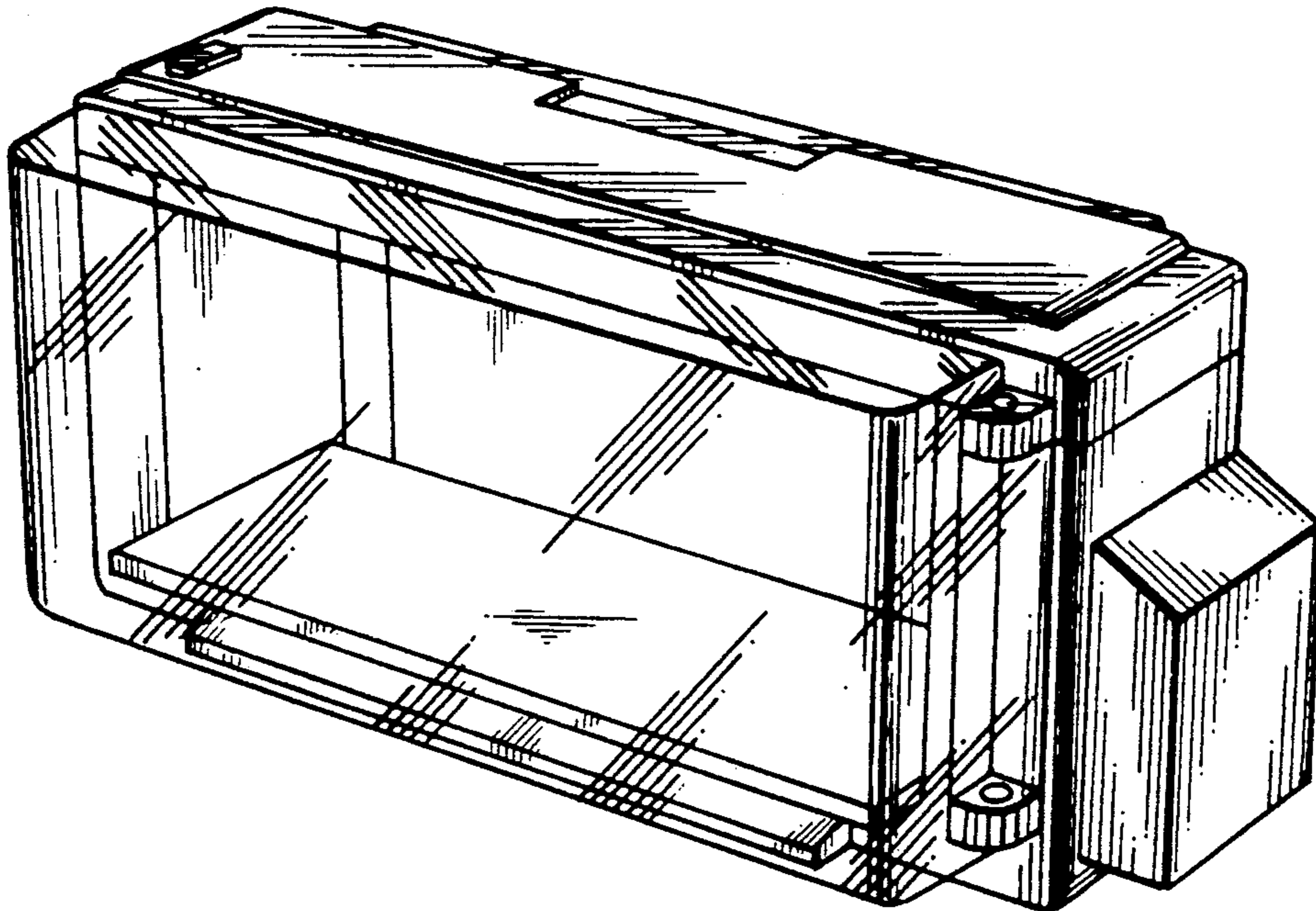

FIG. 1

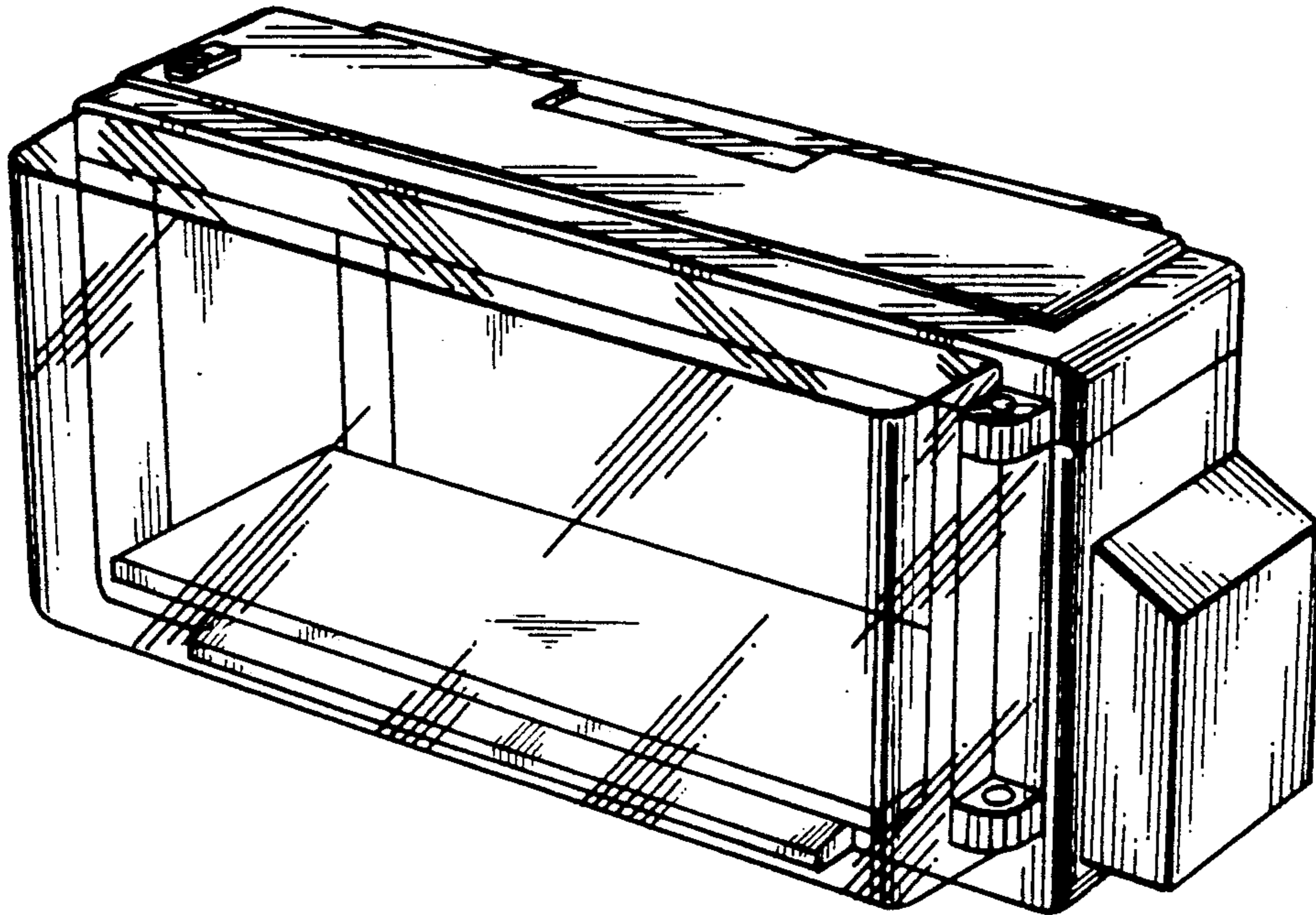
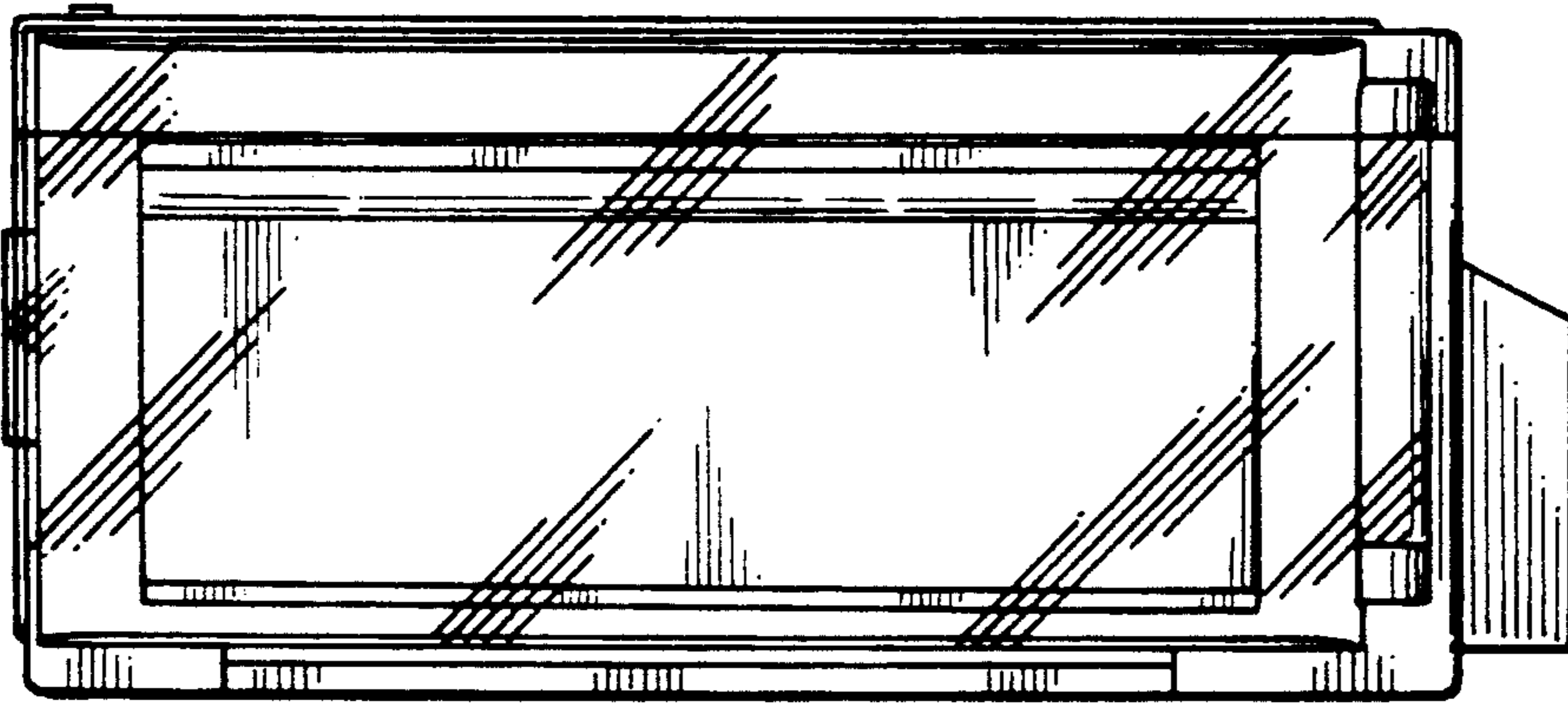

FIG. 2

8



8

FIG. 3

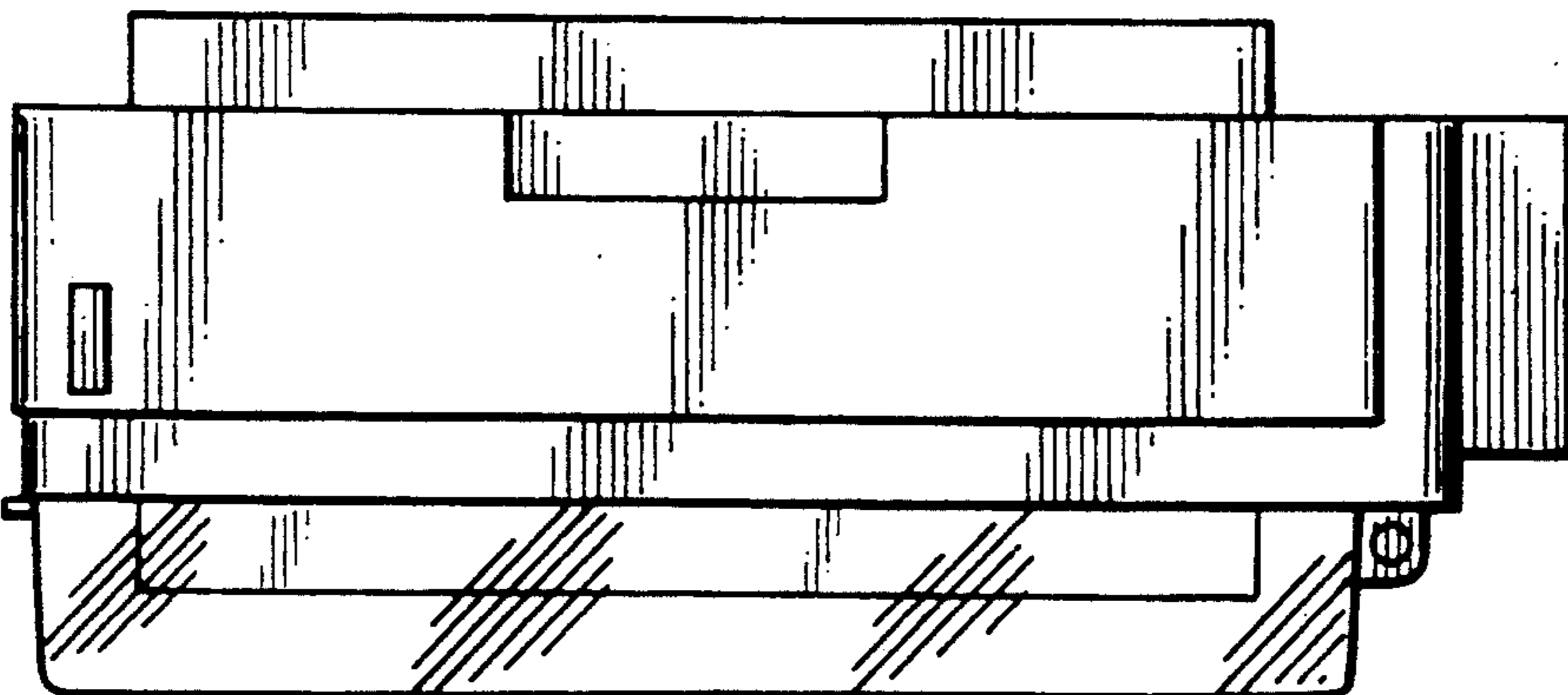

FIG. 4

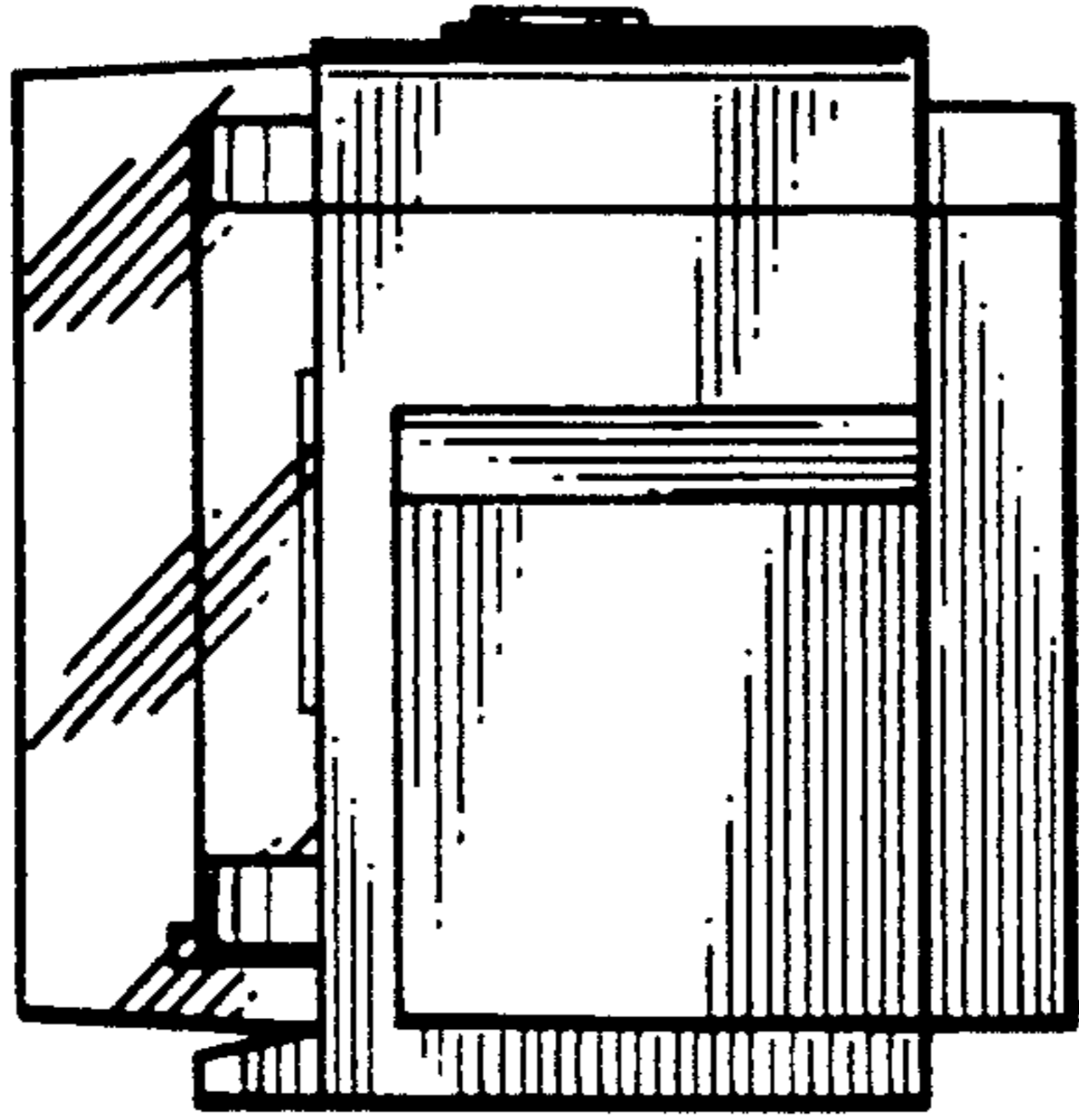

FIG. 5

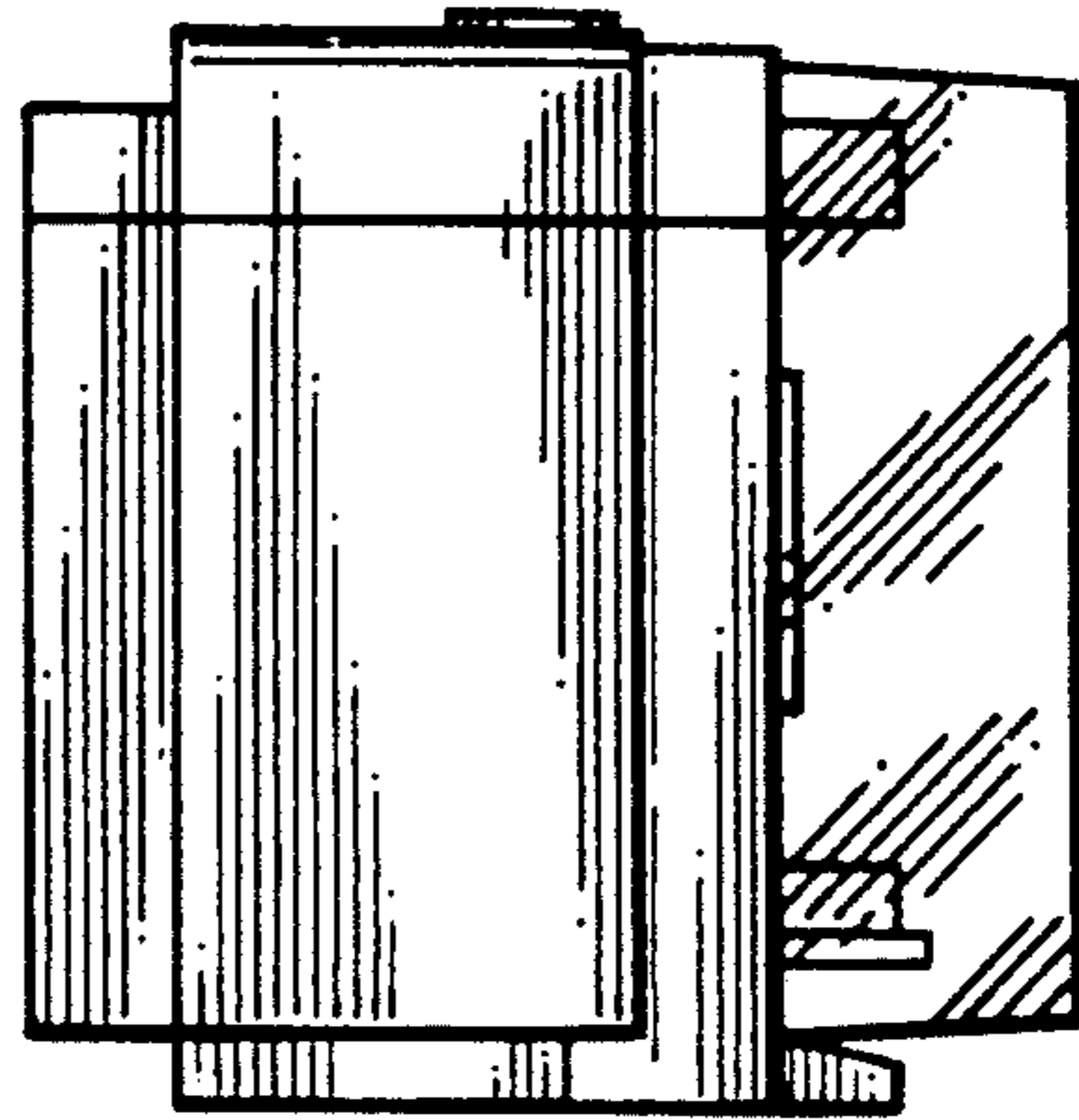

FIG. 6

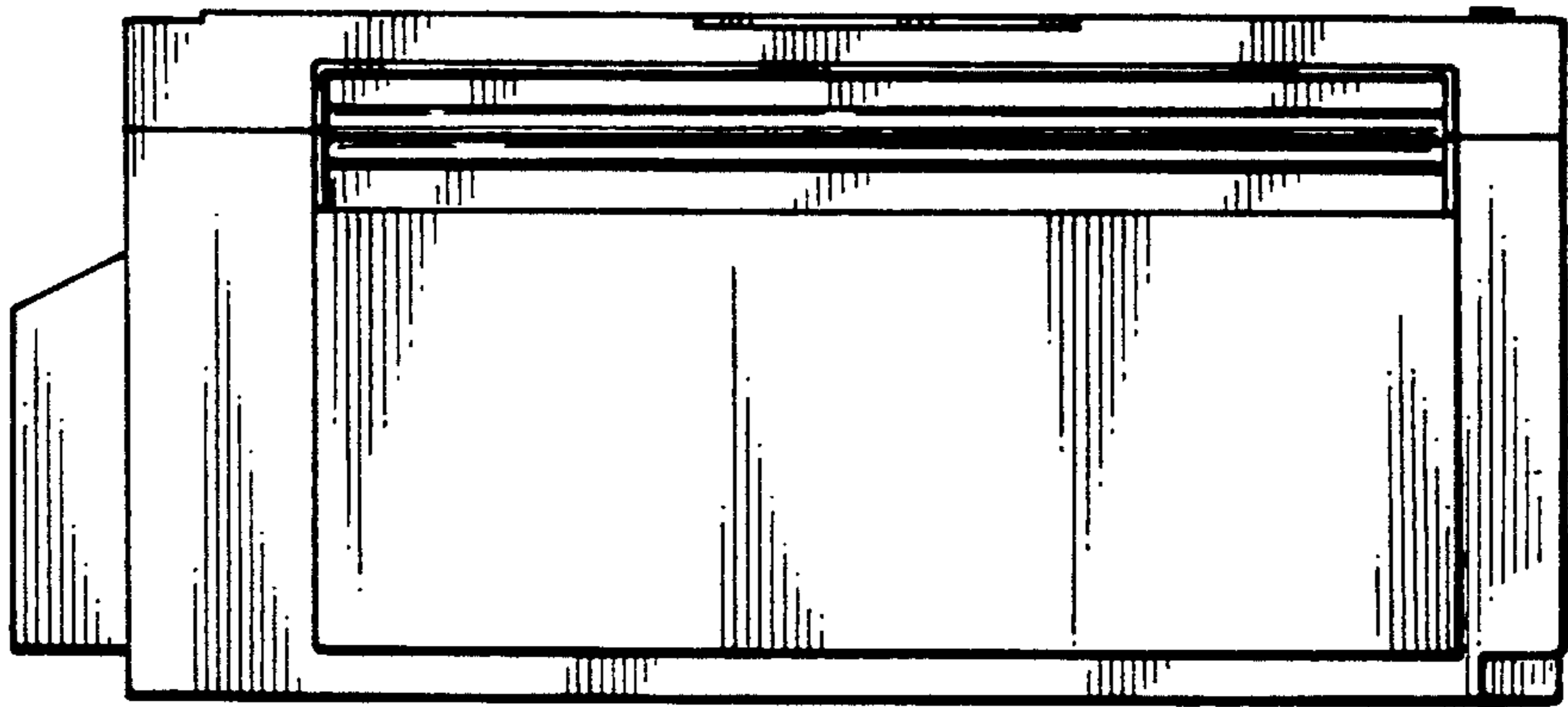

FIG. 7

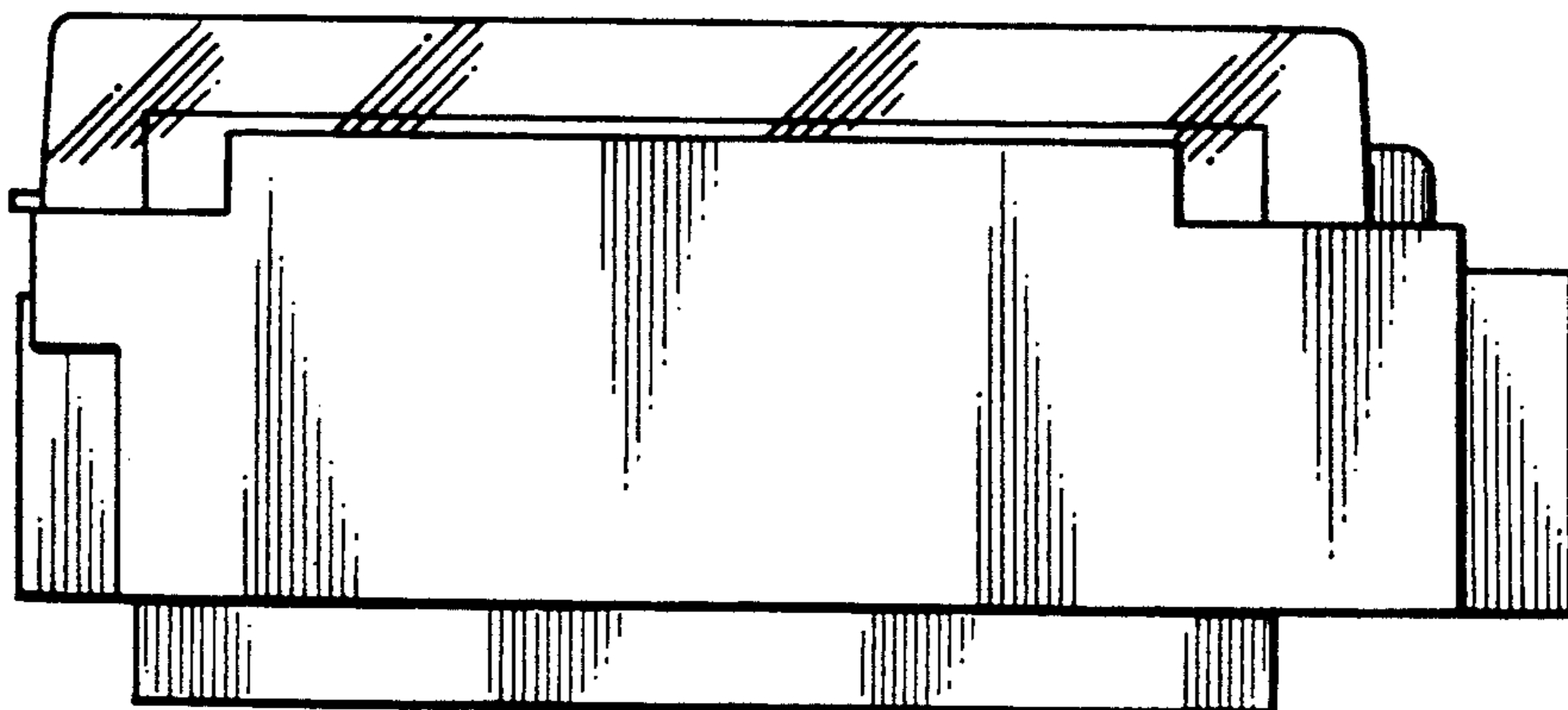

FIG. 8

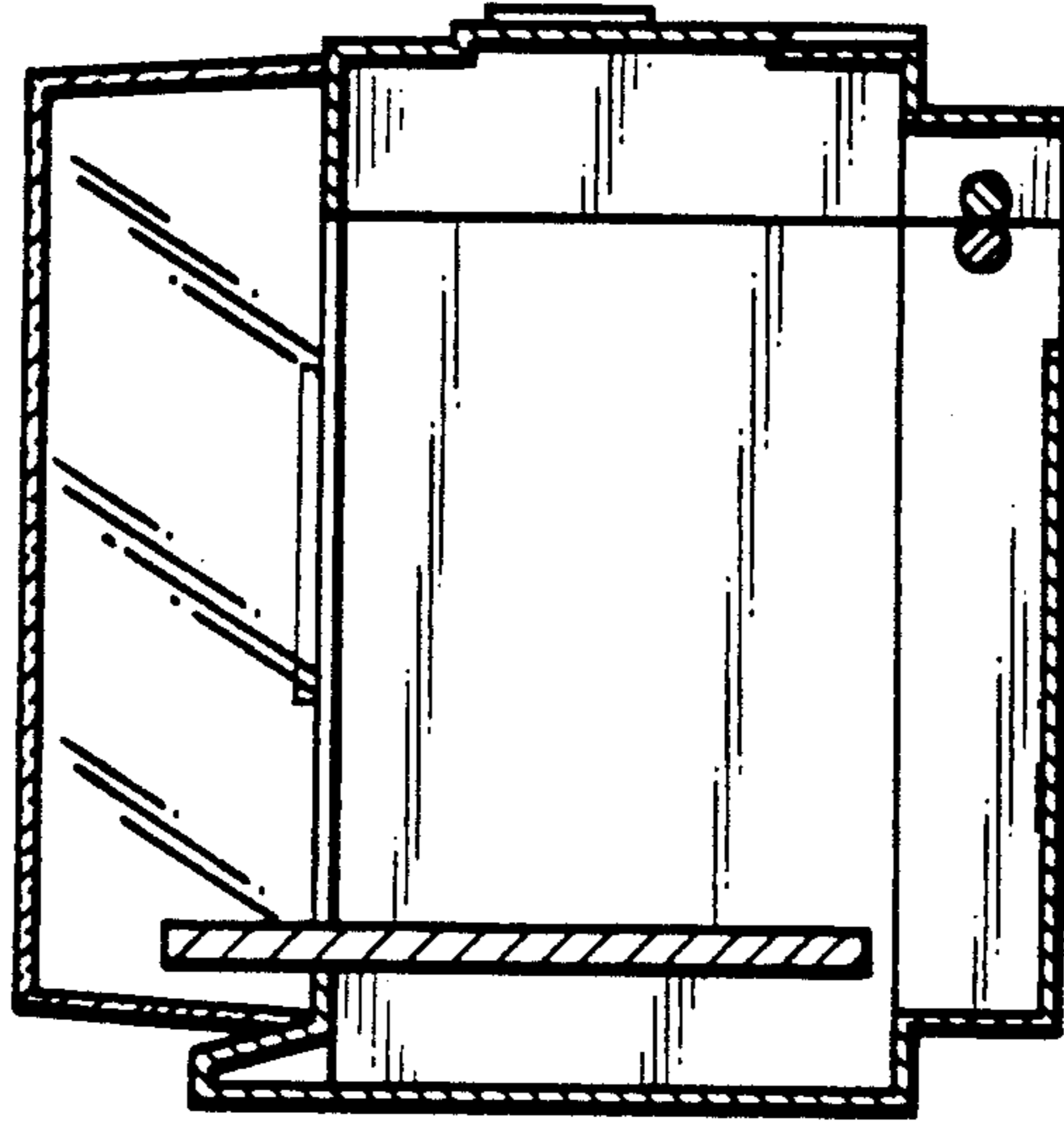

FIG. 9

