



US00D341714S

United States Patent [19]

[11] Patent Number: **Des. 341,714**

Ancona et al.

[45] Date of Patent: **** Nov. 30, 1993**

- [54] ORGANIZER FOR SEWING SUPPLIES
- [75] Inventors: **Bruce Ancona; Jane Ancona**, both of New York, N.Y.
- [73] Assignee: **M. Kamenstein, Inc.**, White Plains, N.Y.
- [**] Term: **14 Years**
- [21] Appl. No.: **729,090**
- [22] Filed: **Jul. 16, 1991**
- [52] U.S. Cl. **D3/20; D3/39**
- [58] Field of Search **D3/20, 23, 25, 39; D28/38, 61, 83, 76-78, 73; 206/235, 581, 823; 223/106-109 A, 111**

Attorney, Agent, or Firm—James A. Drobile; Robert A. Koons; Robert Rosenthal

[57] CLAIM

The ornamental design for an organizer for sewing supplies, as shown.

DESCRIPTION

FIG. 1 is a perspective view of an organizer for sewing supplies in accordance with the present invention; FIG. 2 is an elevational view of the front, referenced to the view depicted in FIG. 1, of an organizer for sewing supplies in accordance with the present invention; FIG. 3 is an elevational view of the rear, referenced to the view depicted in FIG. 1, of an organizer for sewing supplies in accordance with the present invention; FIG. 4 is an elevational view of the top, referenced to the view depicted in FIG. 1, of an organizer for sewing supplies in accordance with the present invention; FIG. 5 is an elevational view of the bottom, referenced to the view depicted in FIG. 1, of an organizer for sewing supplies in accordance with the present invention; and, FIG. 6 is an elevational view of the right side, referenced to the view depicted in FIG. 1, of an organizer for sewing supplies in accordance with the present invention, an elevational view of the left side being a mirror image.

[56] **References Cited**
U.S. PATENT DOCUMENTS

D. 107,340	12/1937	Lux	D3/39
D. 134,053	10/1942	Botham	D3/39
D. 135,357	3/1943	Botham	D3/39
D. 166,127	3/1952	Rothstein	D3/20
D. 258,470	3/1981	Chun	D3/39
D. 282,216	1/1986	Doyel	D3/20
D. 294,773	3/1988	Beatty	D3/23
D. 325,123	4/1992	Tiramani	D3/39
4,504,000	3/1985	Doyel	223/107

Primary Examiner—Louis S. Zarfes

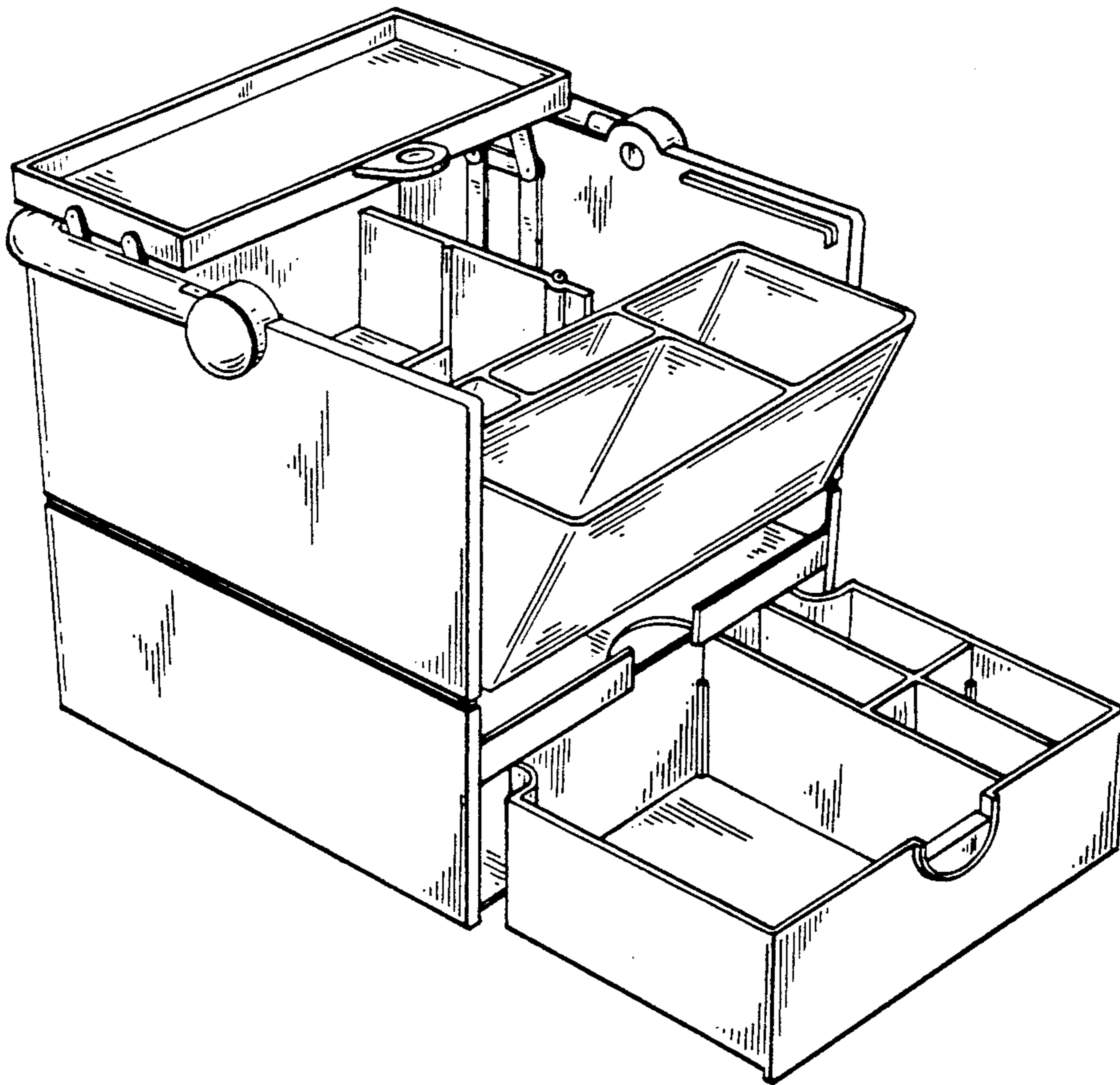

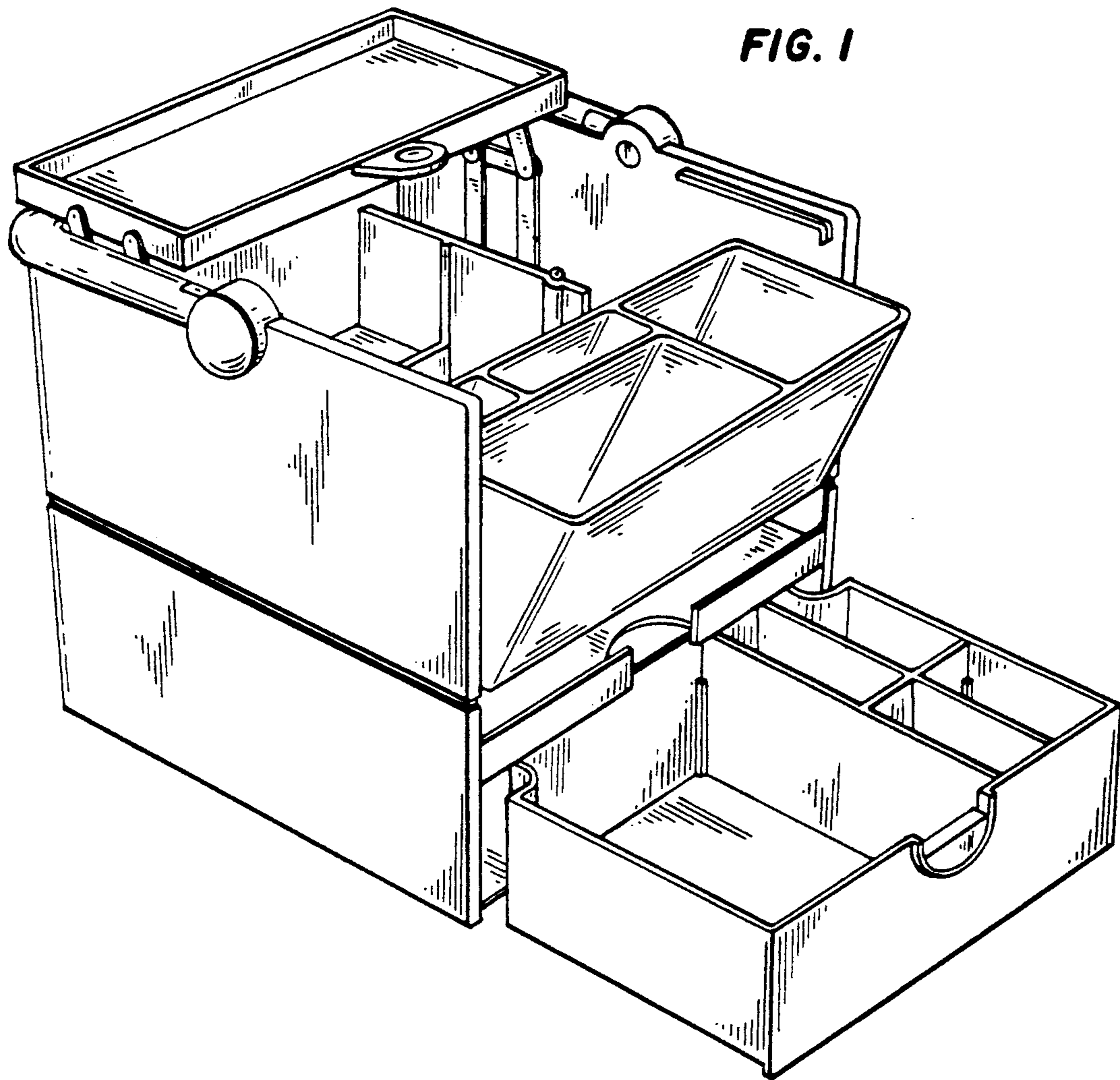

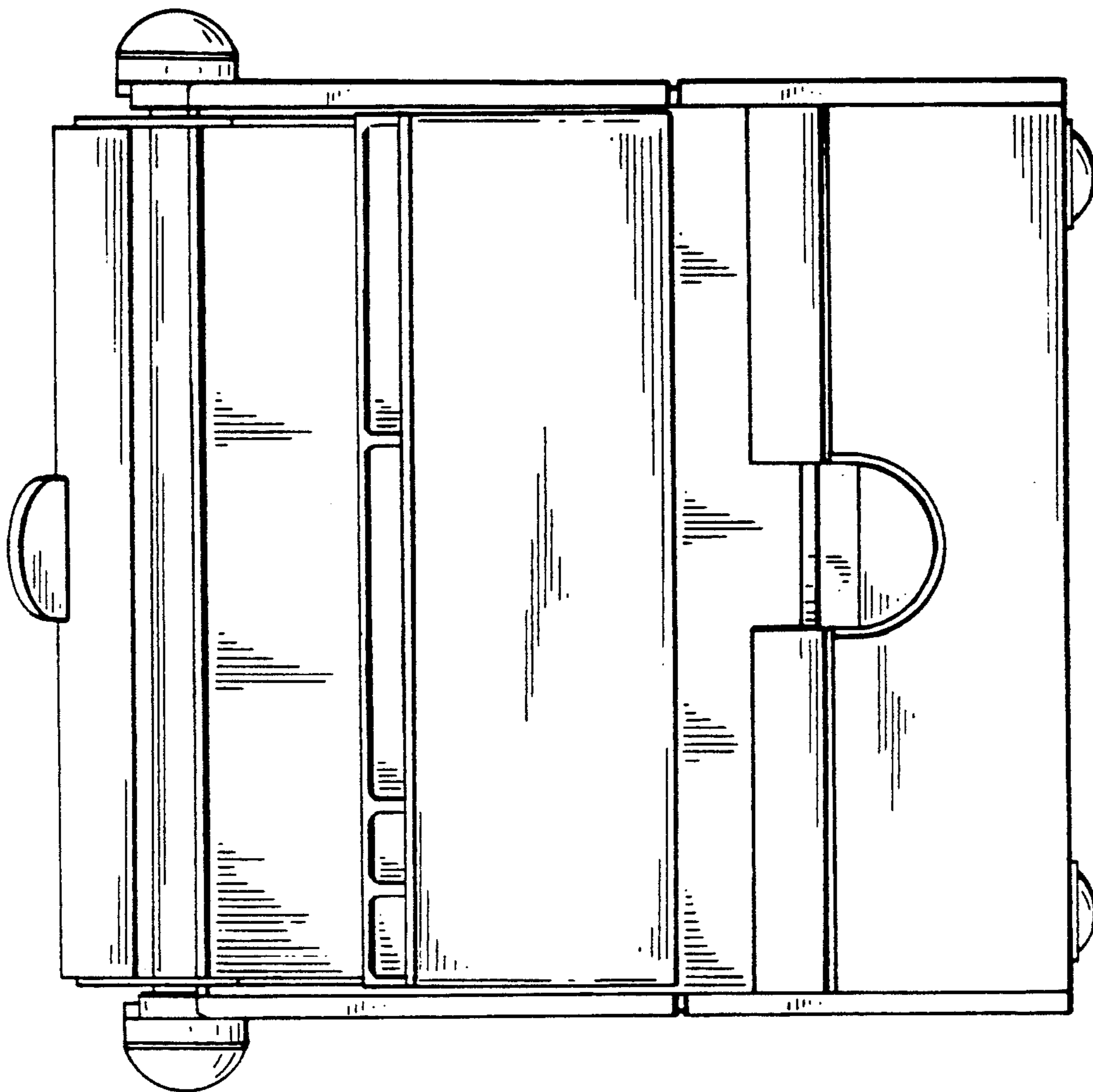

FIG. 2

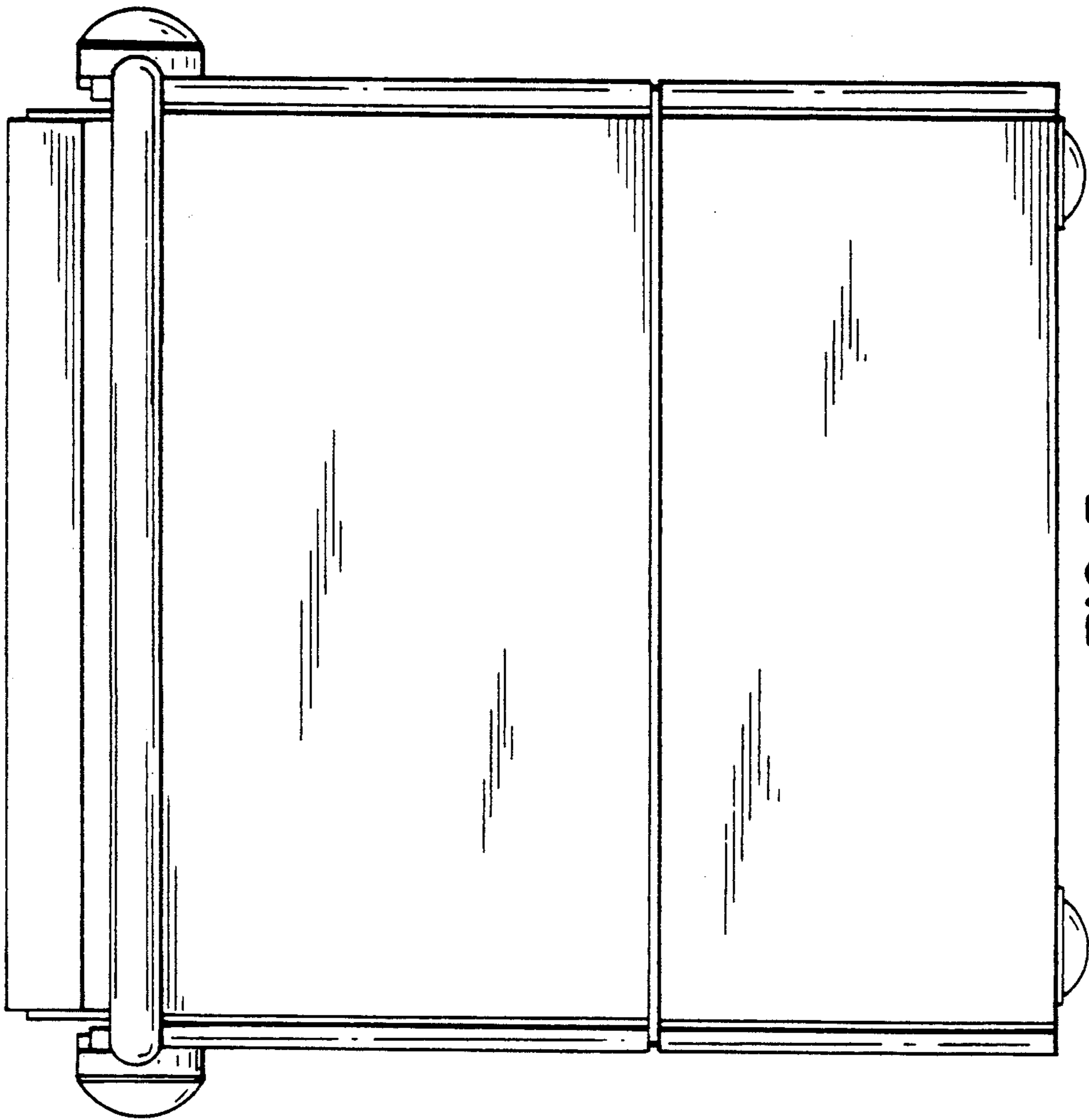

FIG. 3

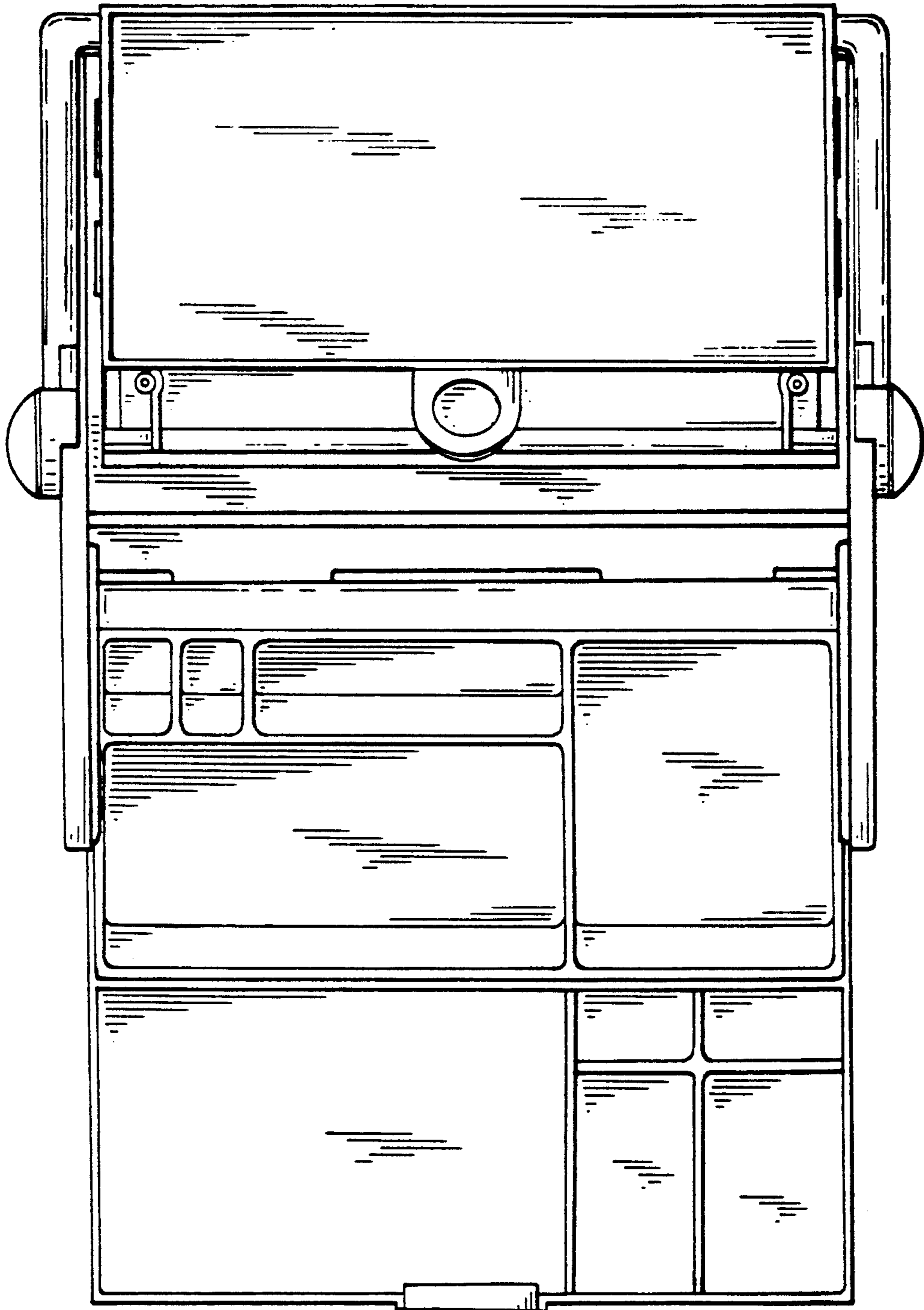

FIG. 4

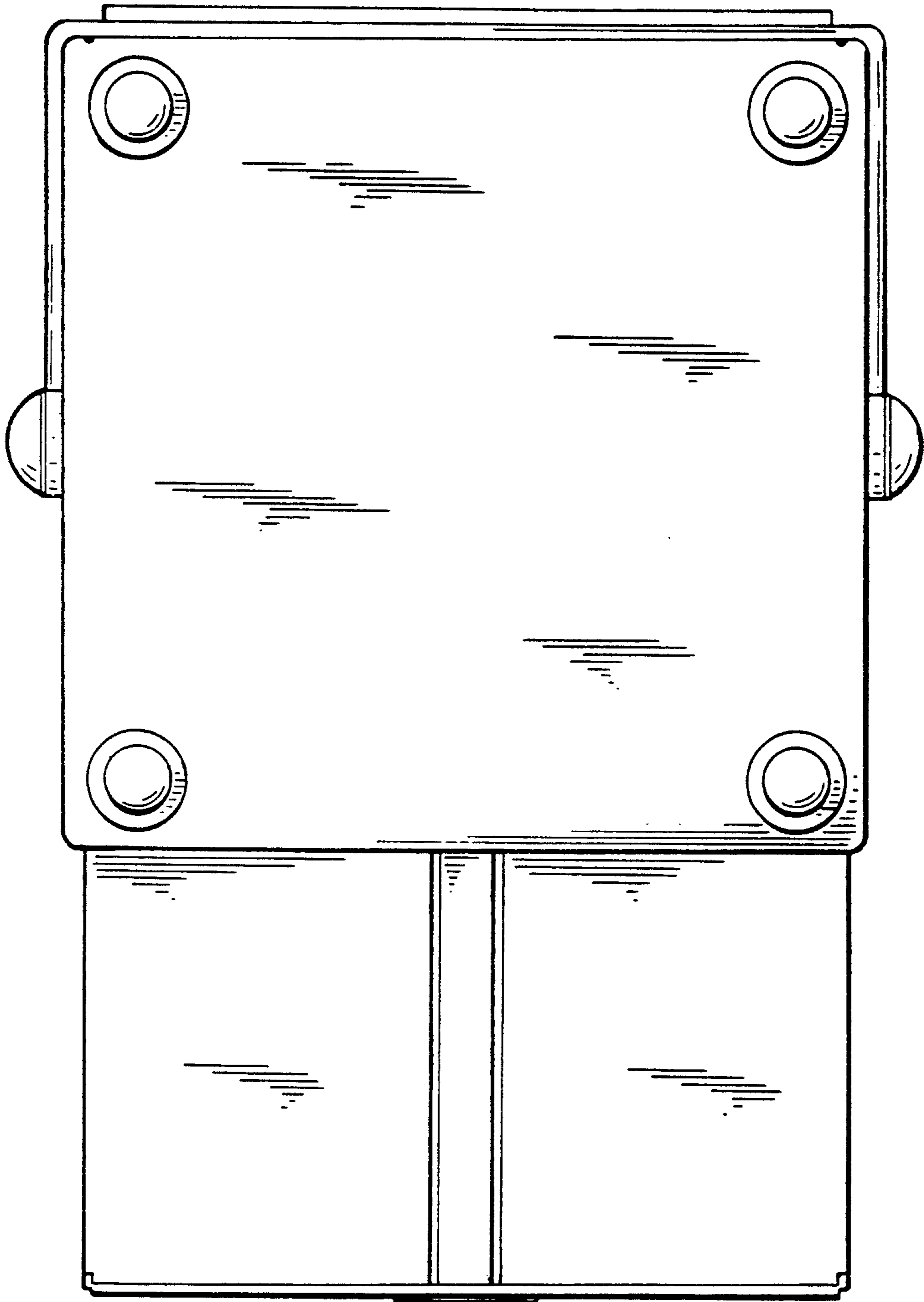

FIG. 5

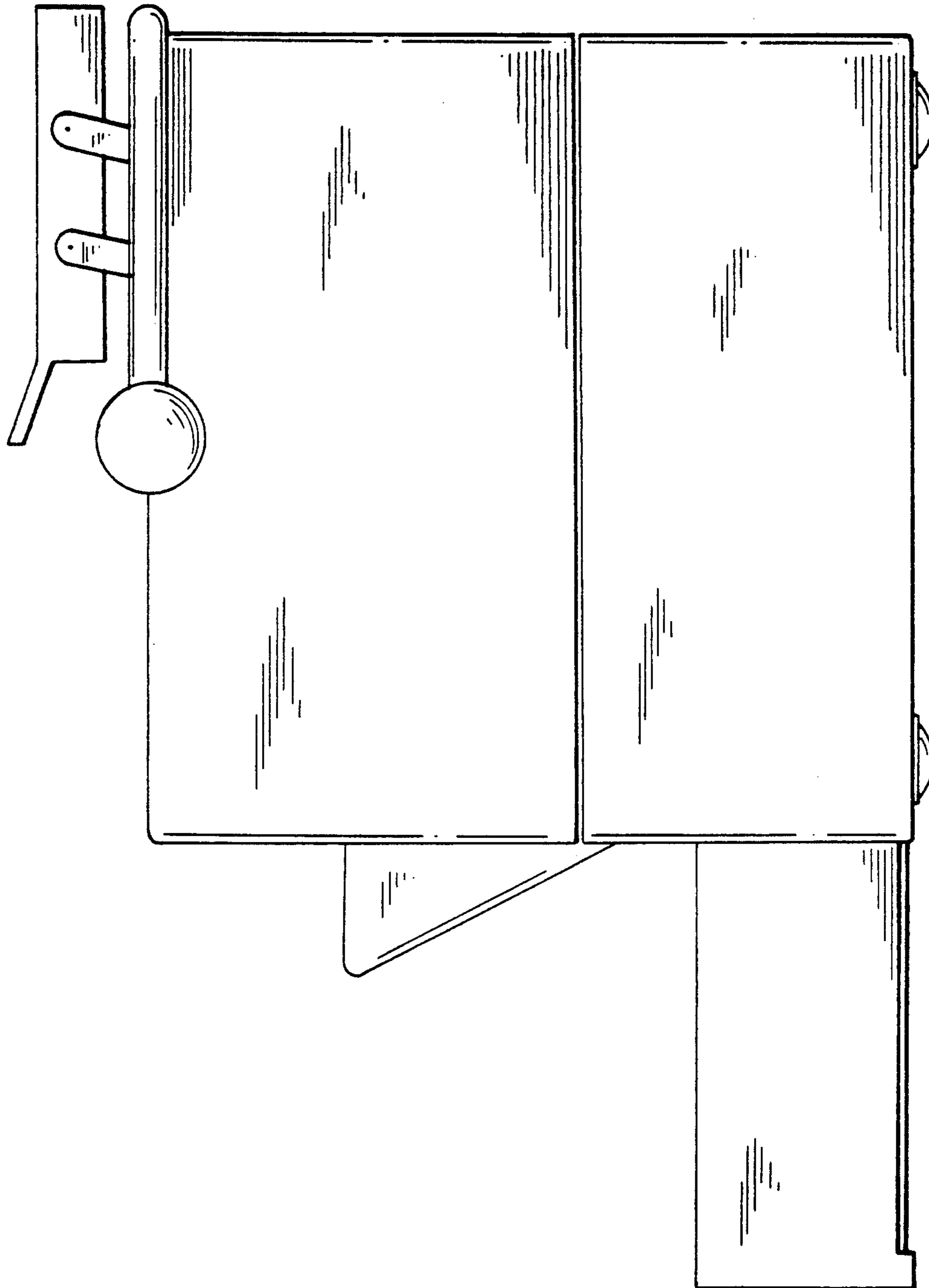

FIG. 6