



US00D341702S

# United States Patent [19]

[11] Patent Number: Des. 341,702

Saito et al.

[45] Date of Patent: \*\* Nov. 30, 1993

[54] SPIKE FOR A SHOE

4,318,231 3/1982 Simoneau ..... 36/134 X

[75] Inventors: Kiyohiro Saito; Yoshiyuki Murakami,  
both of Akashi; Yasufumi Handa,  
Kobe, all of Japan

### FOREIGN PATENT DOCUMENTS

688852 8/1987 Japan .

762928 2/1989 Japan .

1437380 5/1976 United Kingdom ..... 36/67 A

[73] Assignee: Asics Corporation, Hyogo, Japan

Primary Examiner—Louis S. Zarfes

[\*\*] Term: 14 Years

Attorney, Agent, or Firm—Nixon & Vanderhye

[21] Appl. No.: 792,765

### [57] CLAIM

[22] Filed: Nov. 13, 1991

The ornamental design for a spike for a shoe, as shown and described.

### [30] Foreign Application Priority Data

### DESCRIPTION

May 22, 1991 [JP] Japan ..... 3-15014

[52] U.S. Cl. .... D2/962

[58] Field of Search ..... D2/311, 314, 317;  
D30/147-150; 36/59 A, 67 D, 67 R-67 B, 134

FIG. 1 is an illustrative view in a position of use. The broken line showing of the shoe in FIG. 1 is for illustrative purposes only and forms no part of the claimed design;

FIG. 2 is a front elevational view thereof;

FIG. 3 is a rear elevational view thereof;

FIG. 4 is a top plan view thereof;

FIG. 5 is a bottom plan view thereof;

FIG. 6 is a left side elevational view thereof;

FIG. 7 is a right side elevational view thereof; and,

FIG. 8 is a perspective view thereof.

### [56] References Cited

#### U.S. PATENT DOCUMENTS

D. 257,908 1/1981 Inohara ..... D2/317

D. 288,262 2/1987 Yokoishi ..... D2/317

1,243,209 10/1917 Park ..... 36/134 X

2,844,833 7/1958 Odermatt ..... 36/59 A

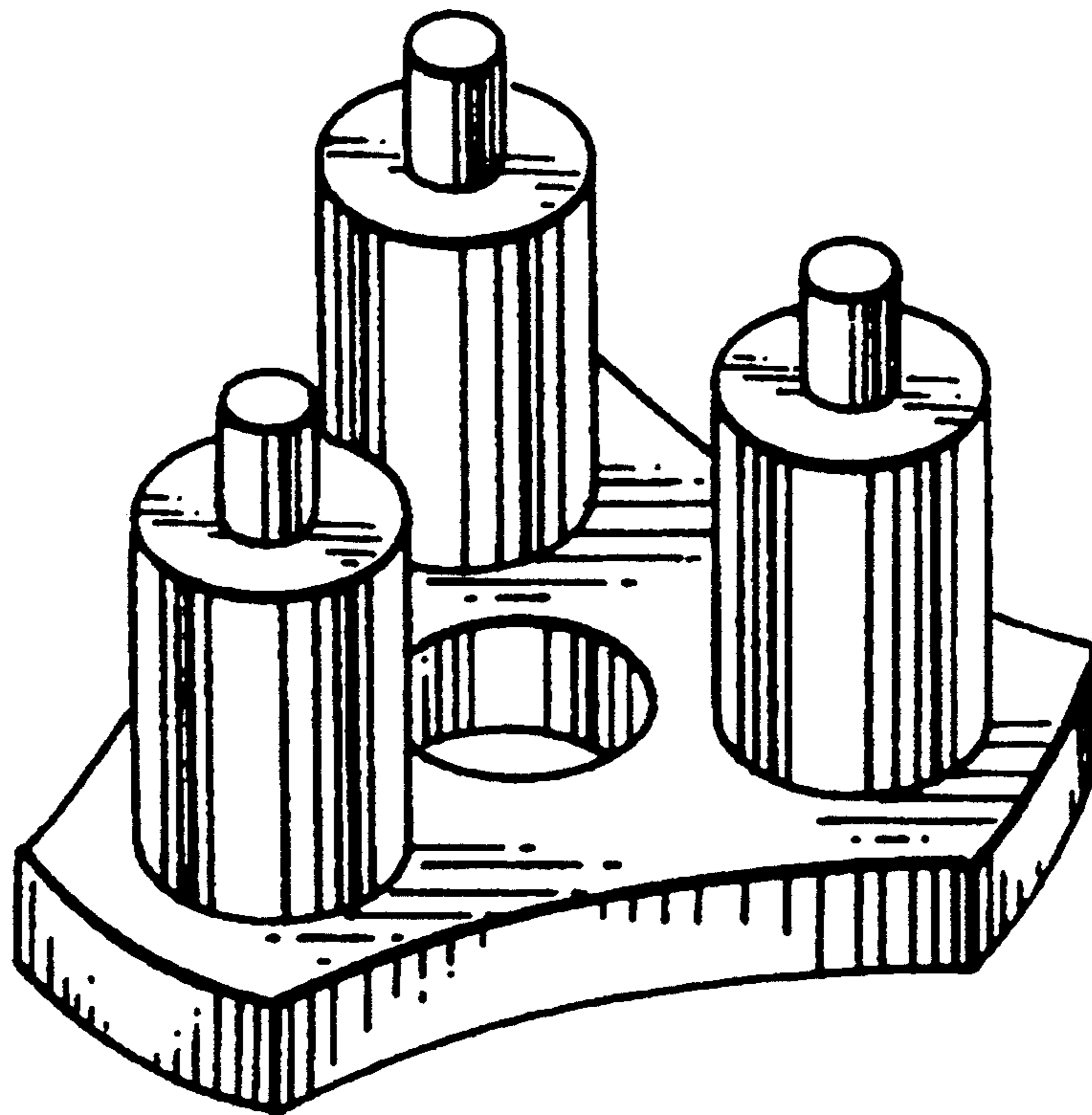

*Fig. 1*

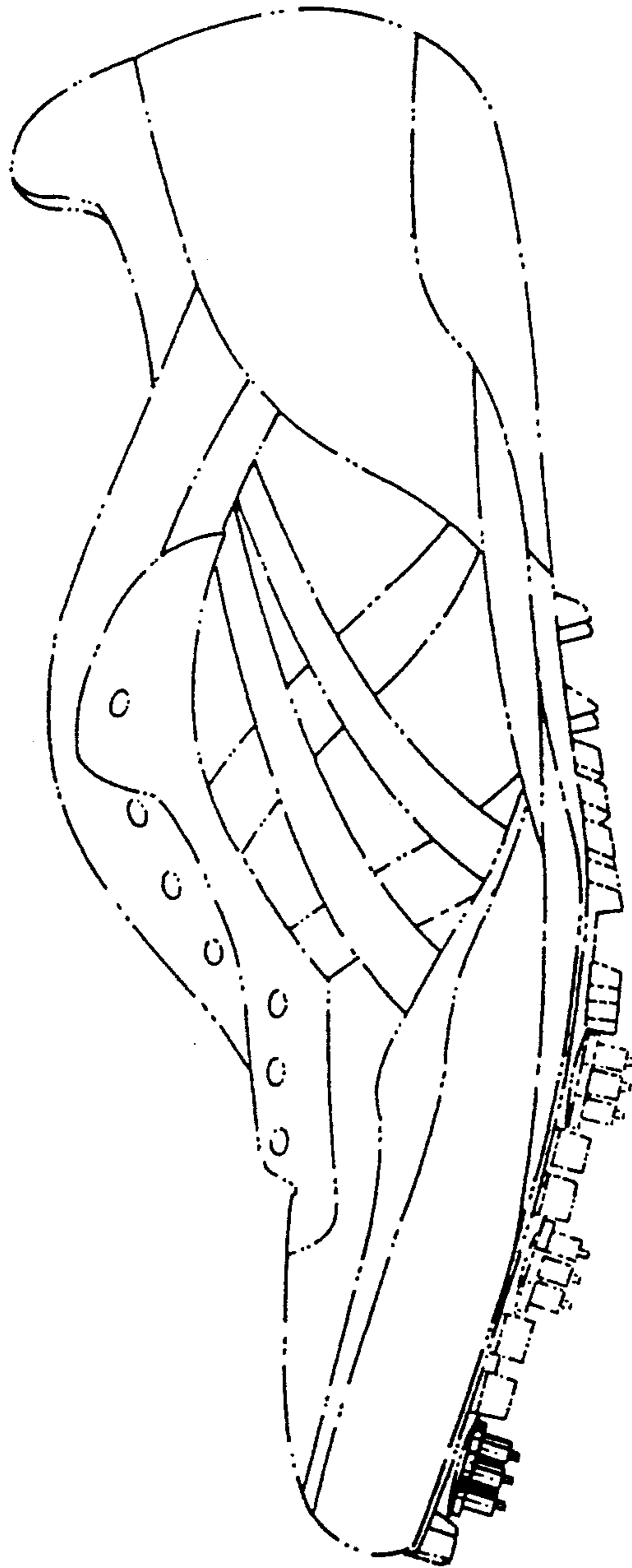

*Fig. 2*

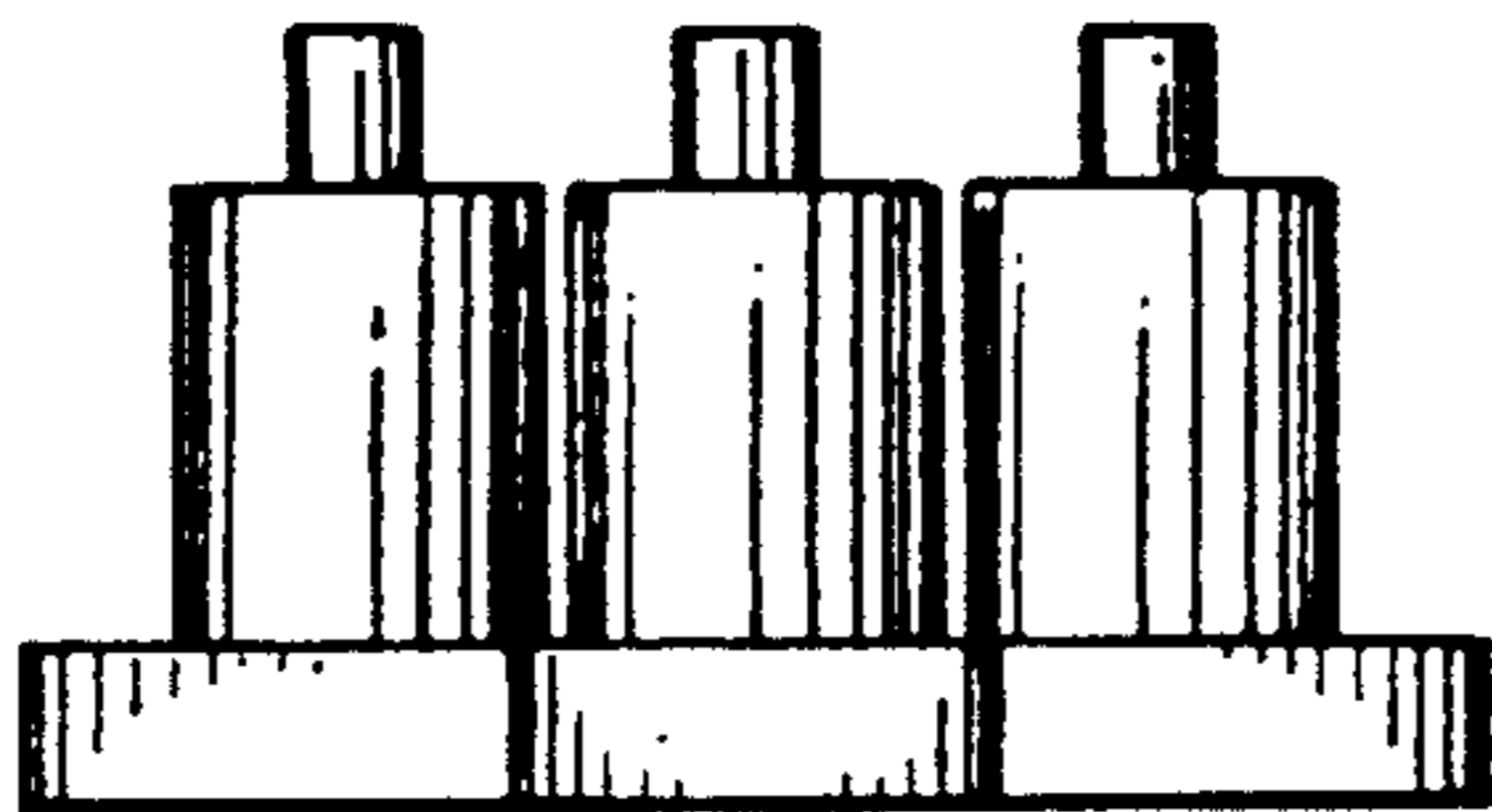

*Fig. 3*

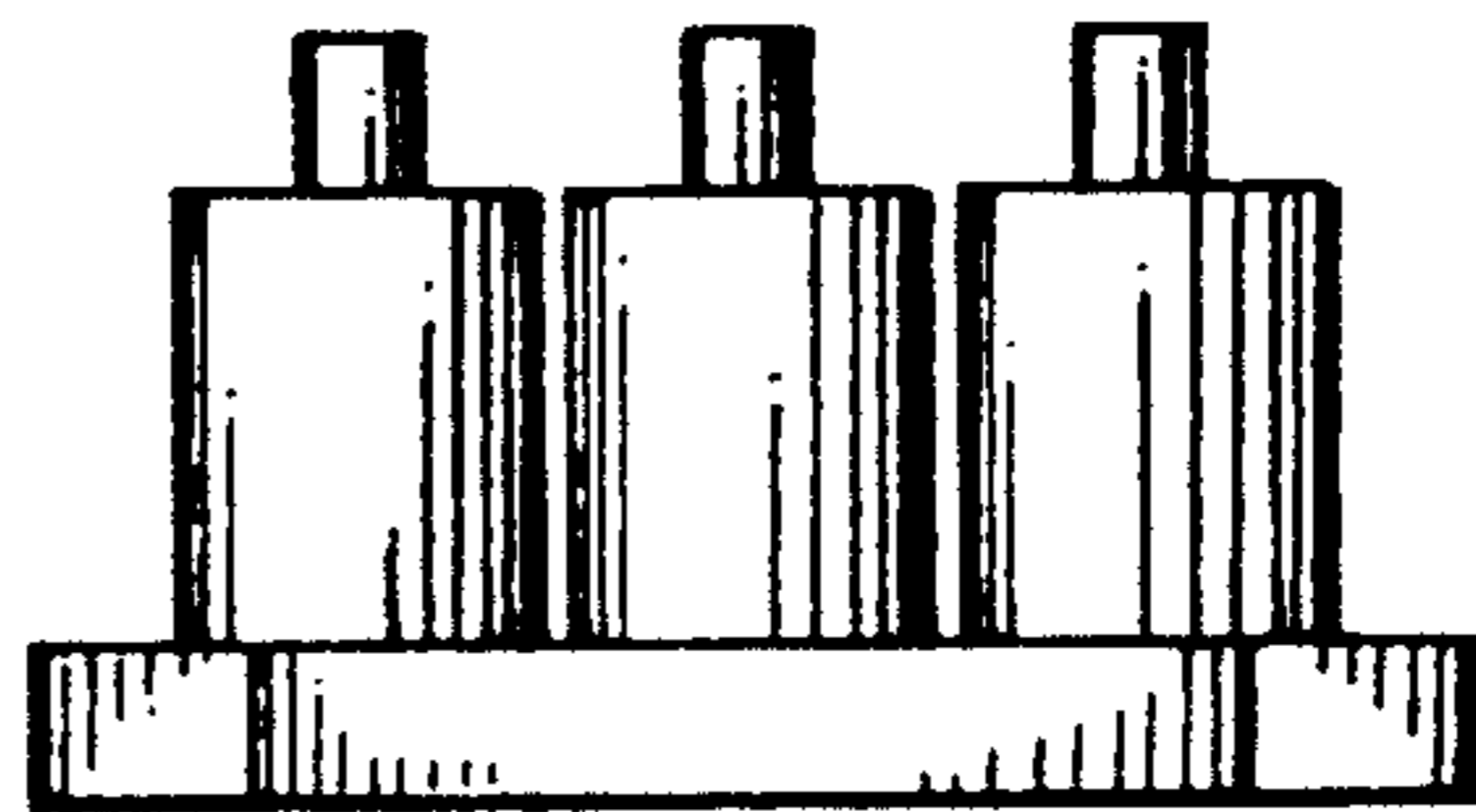

*Fig. 4*

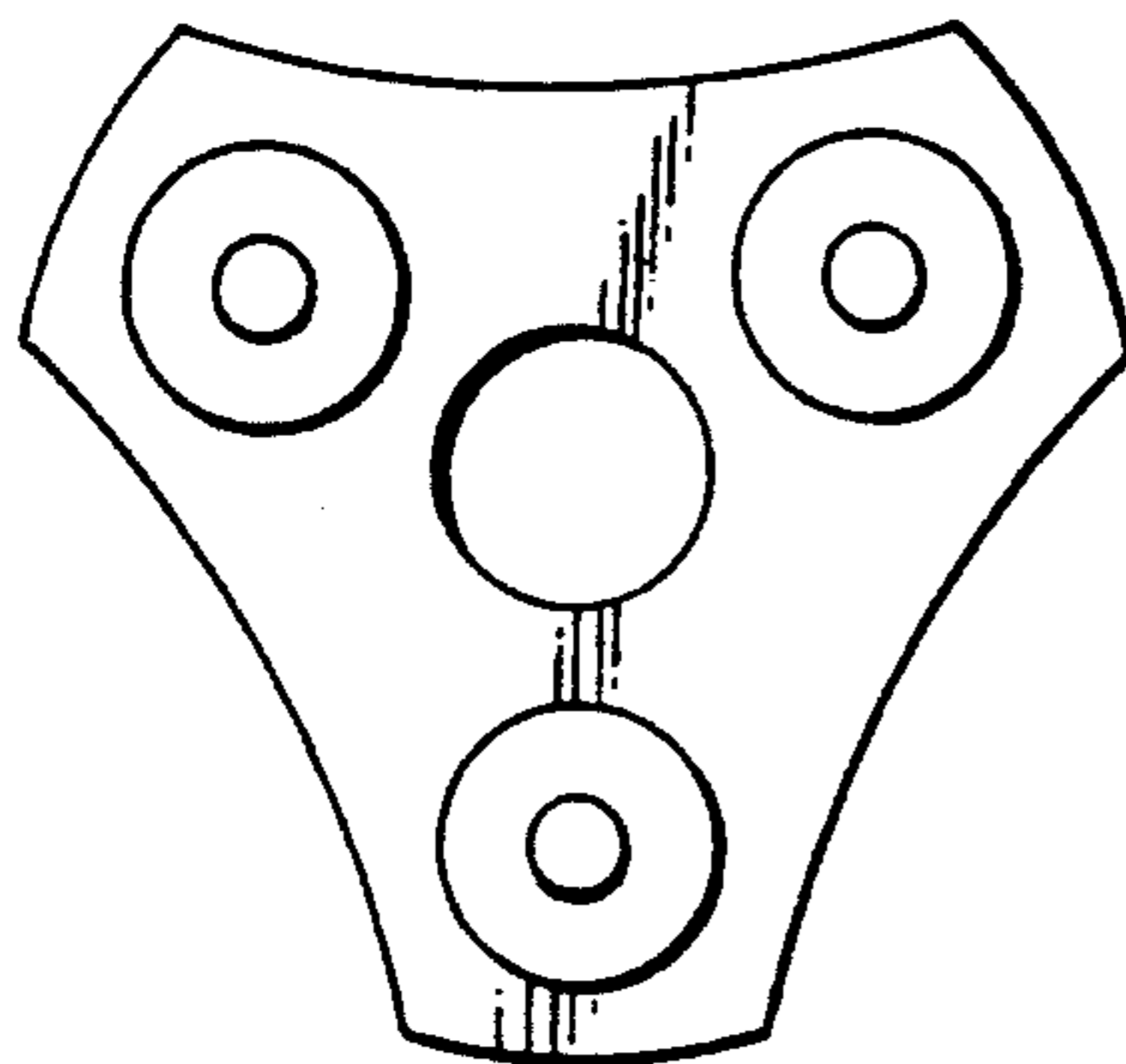

*Fig. 5*

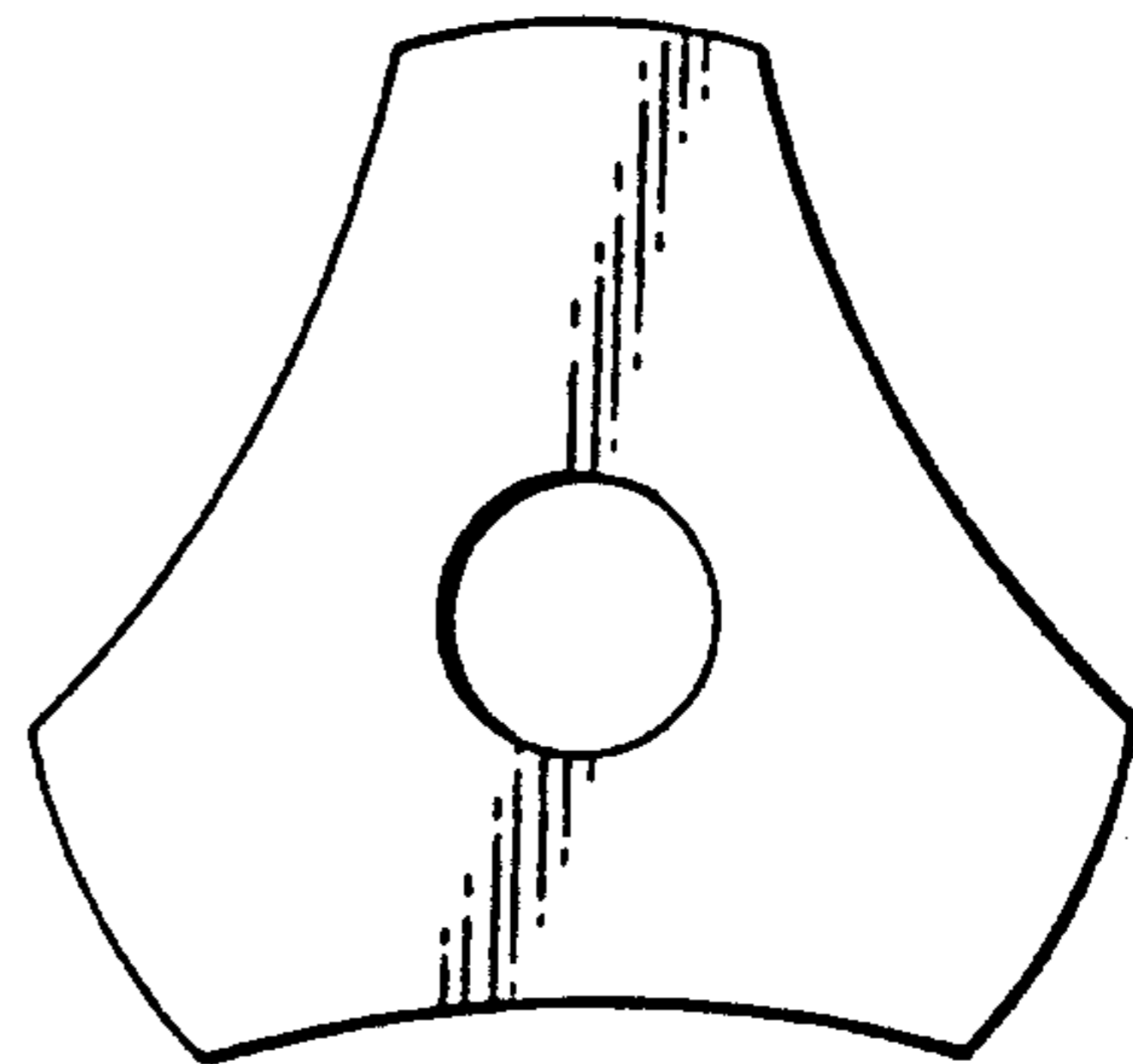

*Fig. 6*

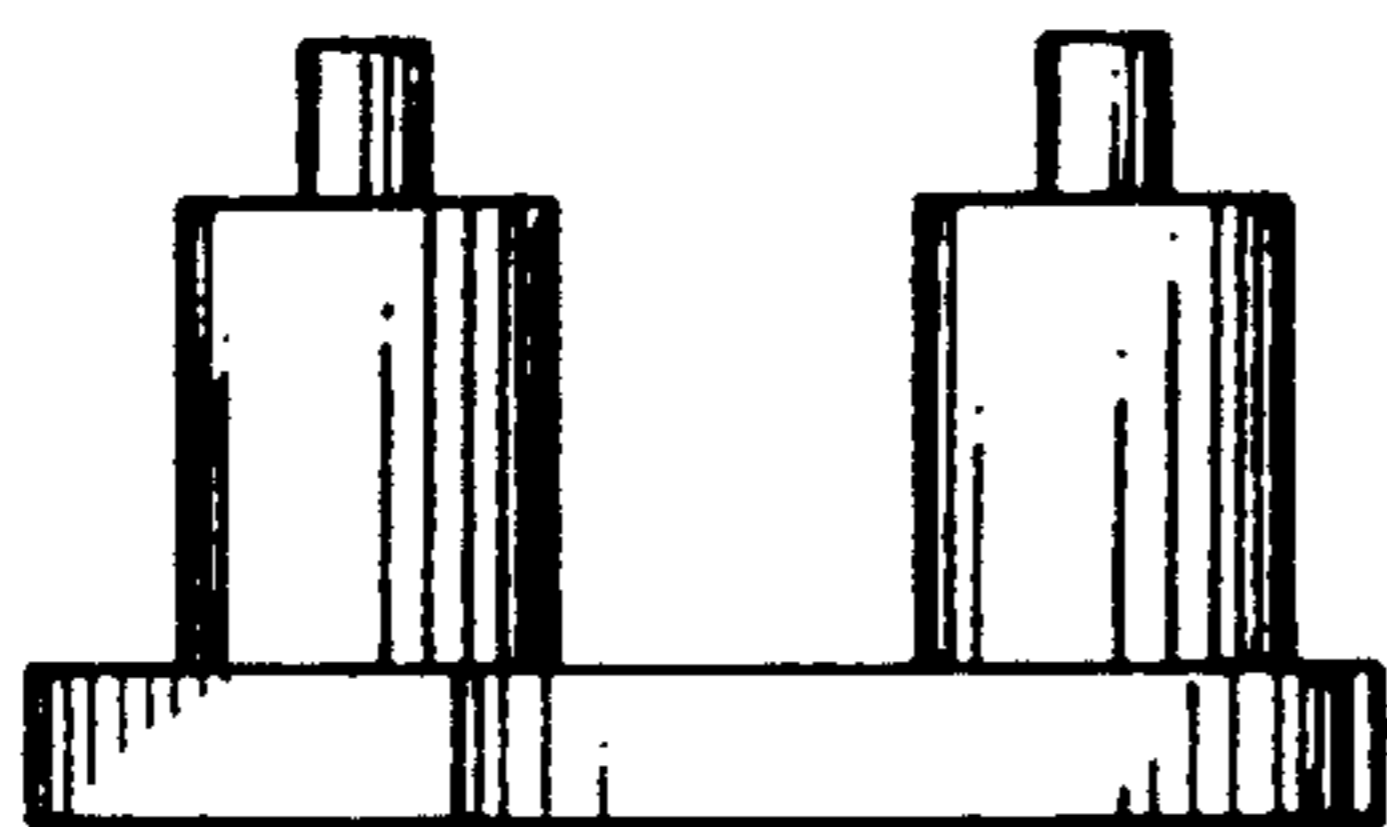

*Fig. 7*

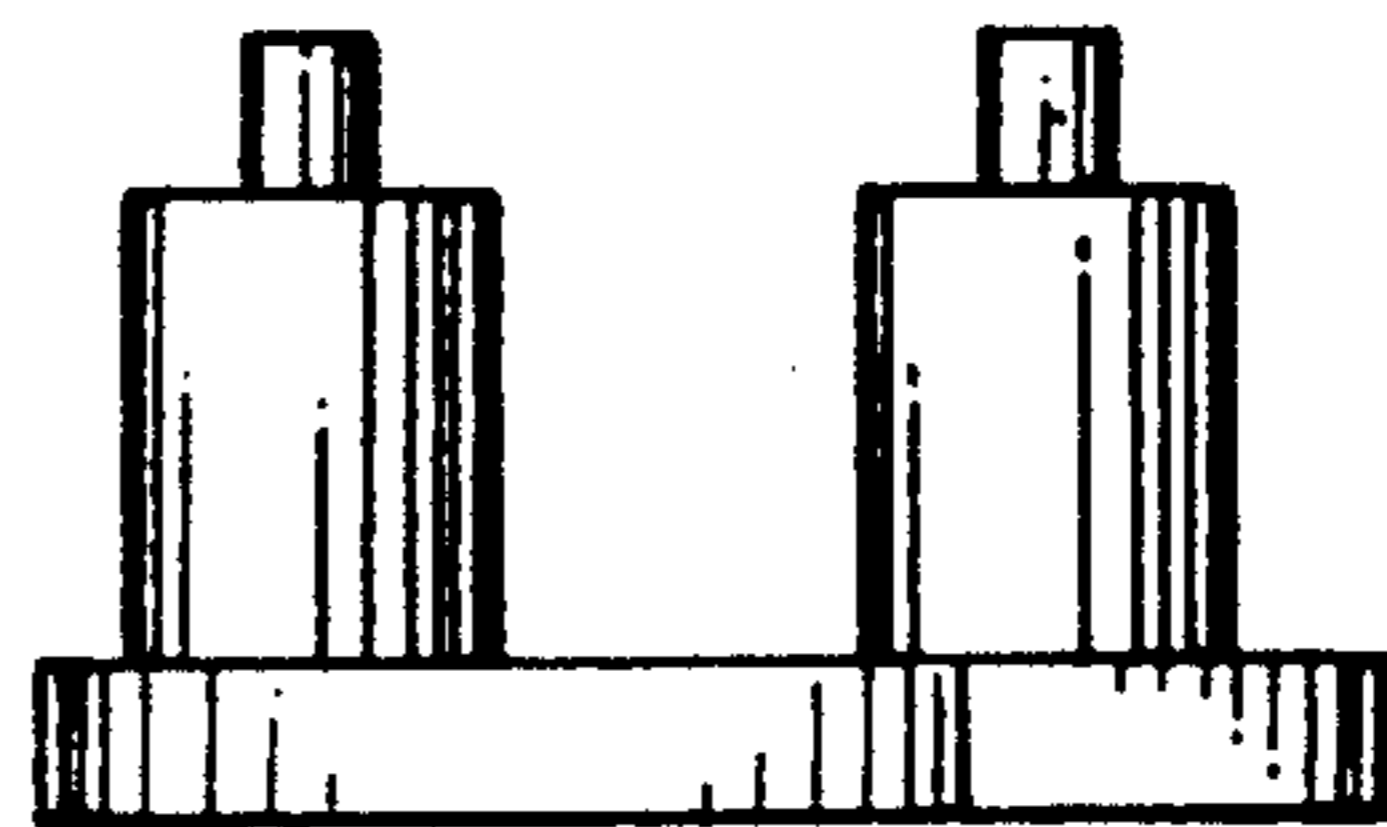

*Fig. 8*

