



US00D341578S

United States Patent [19]

Sato et al.

[11] Patent Number: **Des. 341,578**

[45] Date of Patent: **** Nov. 23, 1993**

[54] **LAP-TOP COMPUTER**

97355 12/1989 Japan D14/106

[75] Inventors: **Yasuharu Sato, Tokyo; Takaya Suzuki, Yamagata; Katsuhiko Kushi, Tokyo, all of Japan**

Primary Examiner—Wallace R. Burke
Assistant Examiner—Freda S. Nunn
Attorney, Agent, or Firm—Sughrue, Mion, Zinn, Macpeak & Seas

[73] Assignee: **NEC Corporation, Tokyo, Japan**

[57] **CLAIM**

[**] Term: **14 Years**

The ornamental design for a lap-top computer, as shown and described.

[21] Appl. No.: **809,072**

DESCRIPTION

[22] Filed: **Dec. 19, 1991**

[30] **Foreign Application Priority Data**

Jun. 20, 1991 [JP] Japan 3-18660[U]
[52] U.S. Cl. **D14/106**
[58] Field of Search D14/100, 101, 106, 113, D14/115; D18/1, 7, 11, 12; 235/145 A, 145 R; 340/700, 706; 341/22, 23; 364/708, 709.04; 361/390, 394

FIG. 1 is a front elevational view of a lap-top computer showing our new design;
FIG. 2 is a rear elevational view thereof;
FIG. 3 is a top plan view thereof;
FIG. 4 is a bottom plan view thereof;
FIG. 5 is a right side elevational view thereof;
FIG. 6 is a left side elevational view thereof;
FIG. 7 is a front top and right side perspective view thereof;
FIG. 8 is a front elevational view thereof with the cover in the closed condition;
FIG. 9 is a right side elevational view thereof;
FIG. 10 is a top plan view thereof;
FIG. 11 is a front top and right side perspective view thereof;
FIG. 12 is a front top and right side perspective view thereof with the cover in the closed condition and the handle pulled out.

[56] **References Cited**

U.S. PATENT DOCUMENTS

D. 313,403 1/1991 Esslinger et al. D14/106
D. 314,558 2/1991 Iino D14/106
D. 334,738 4/1993 Kim D14/106

FOREIGN PATENT DOCUMENTS

685121 8/1986 Japan D14/106

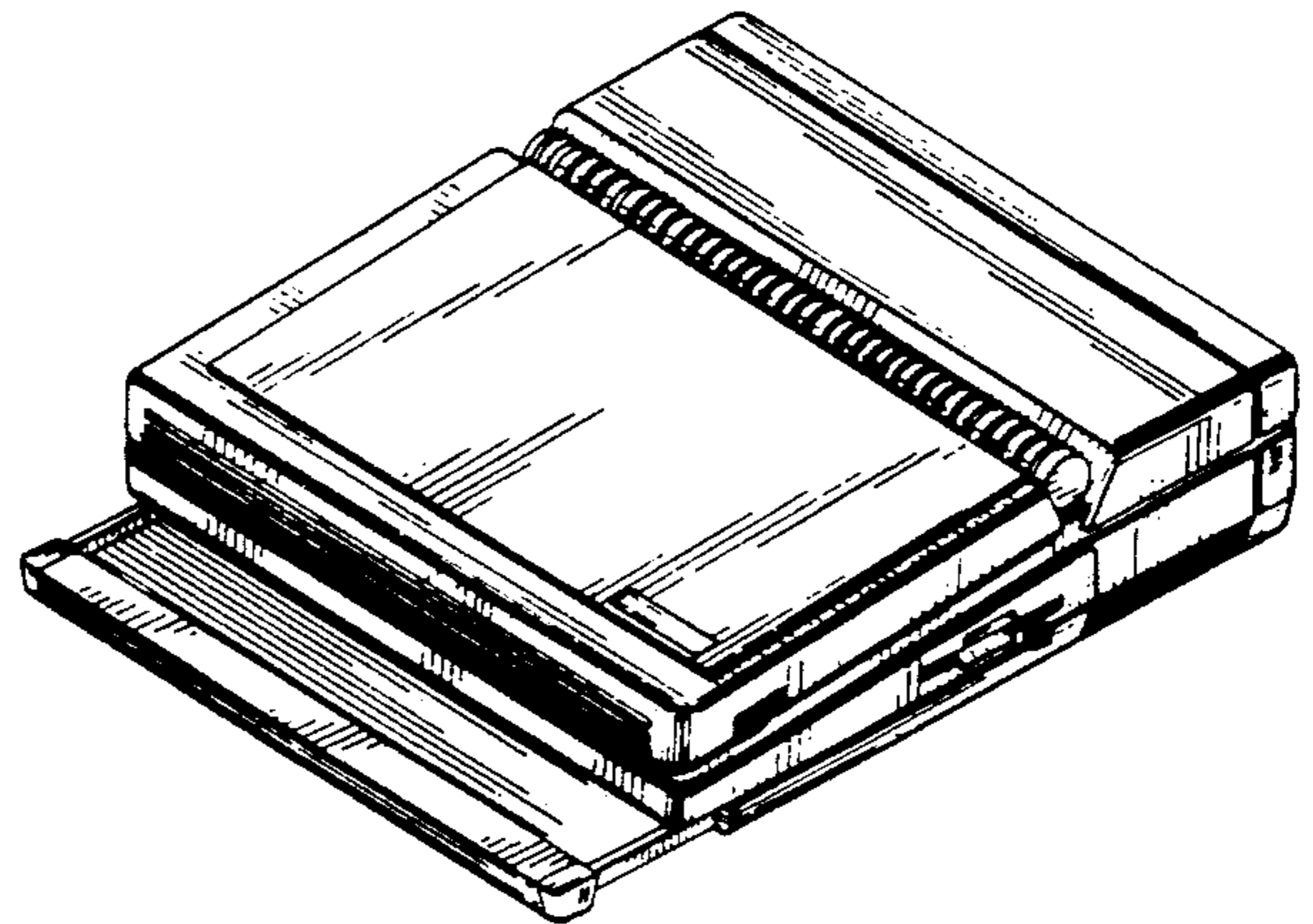
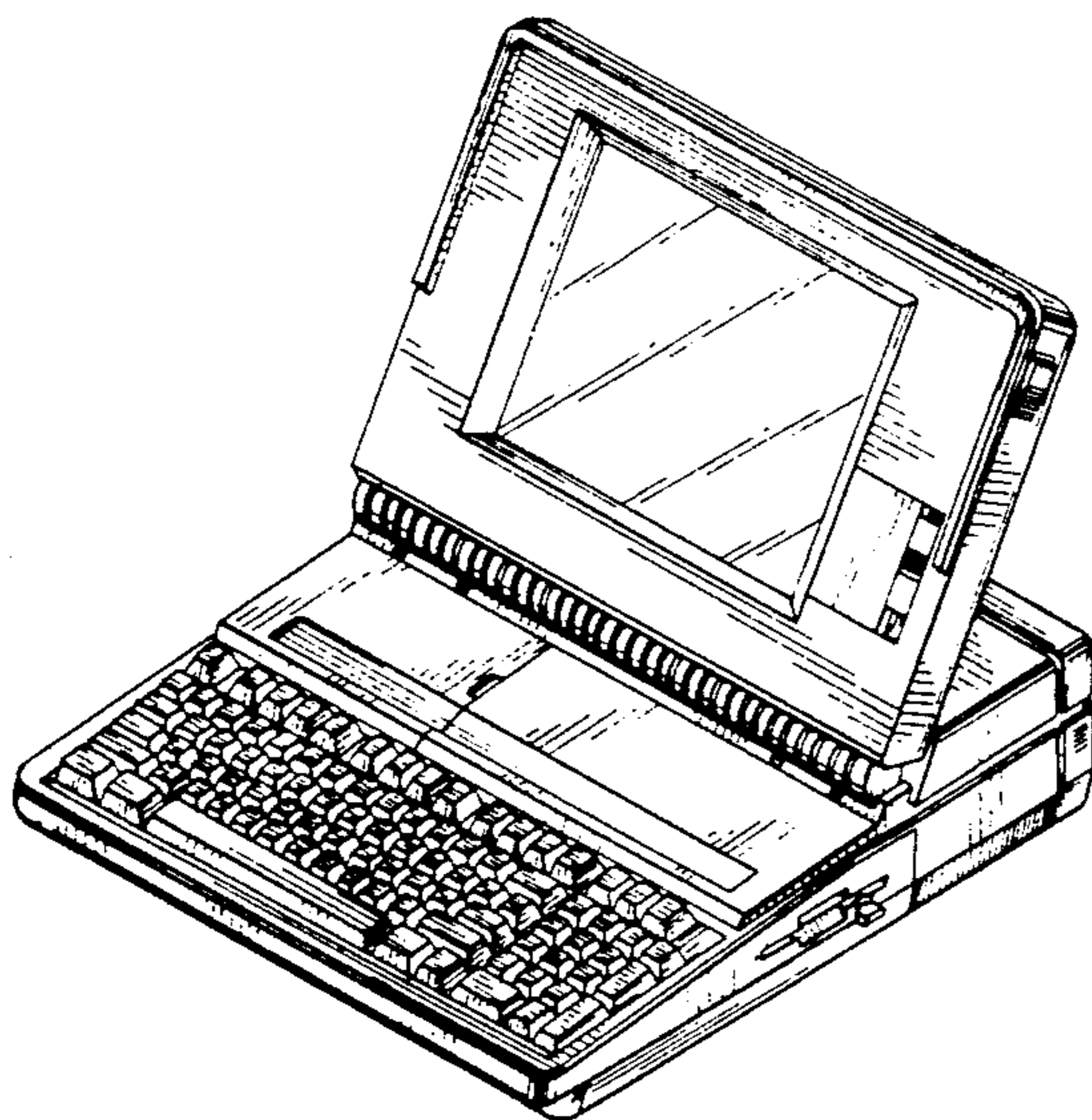

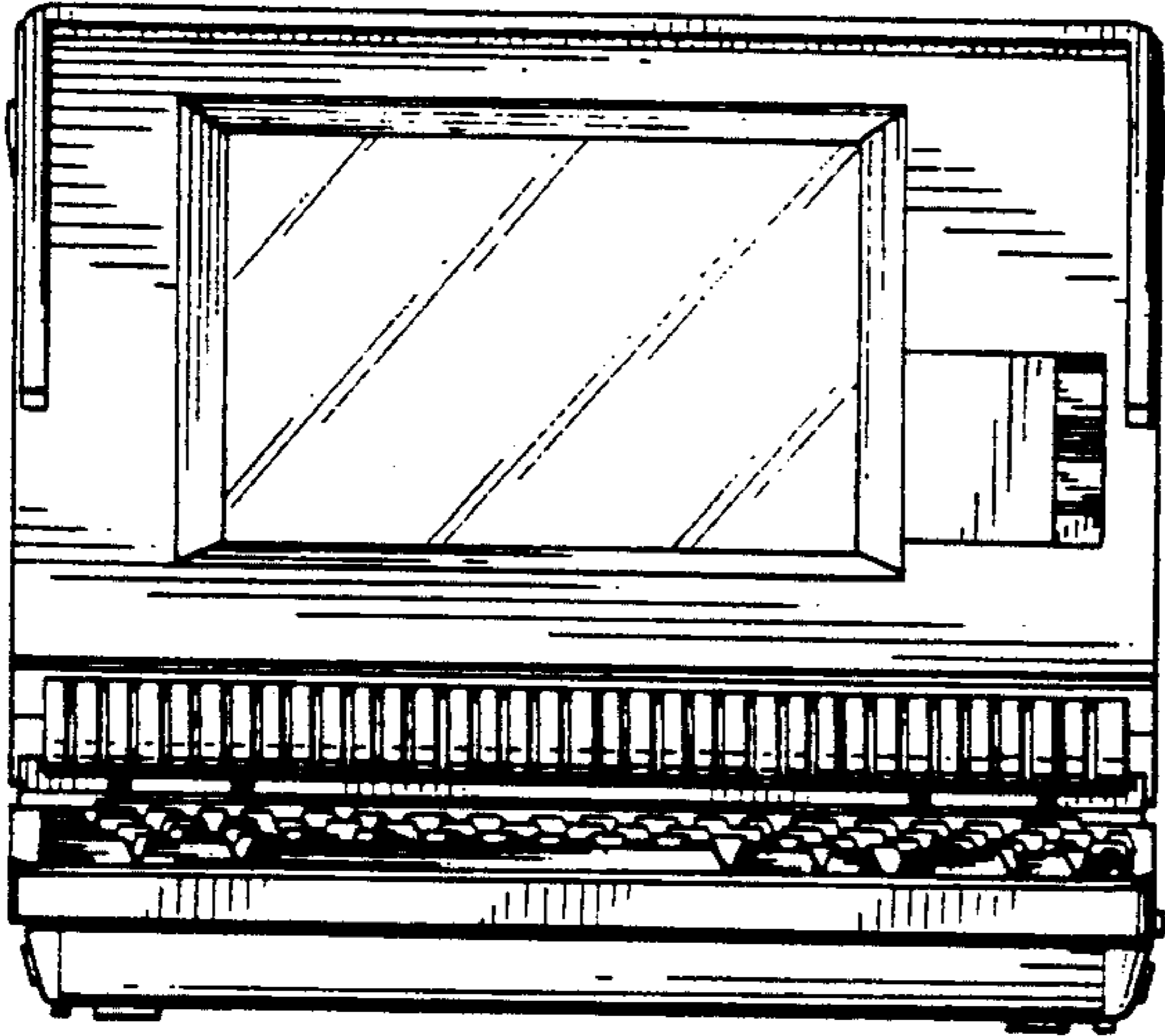

FIG. 1

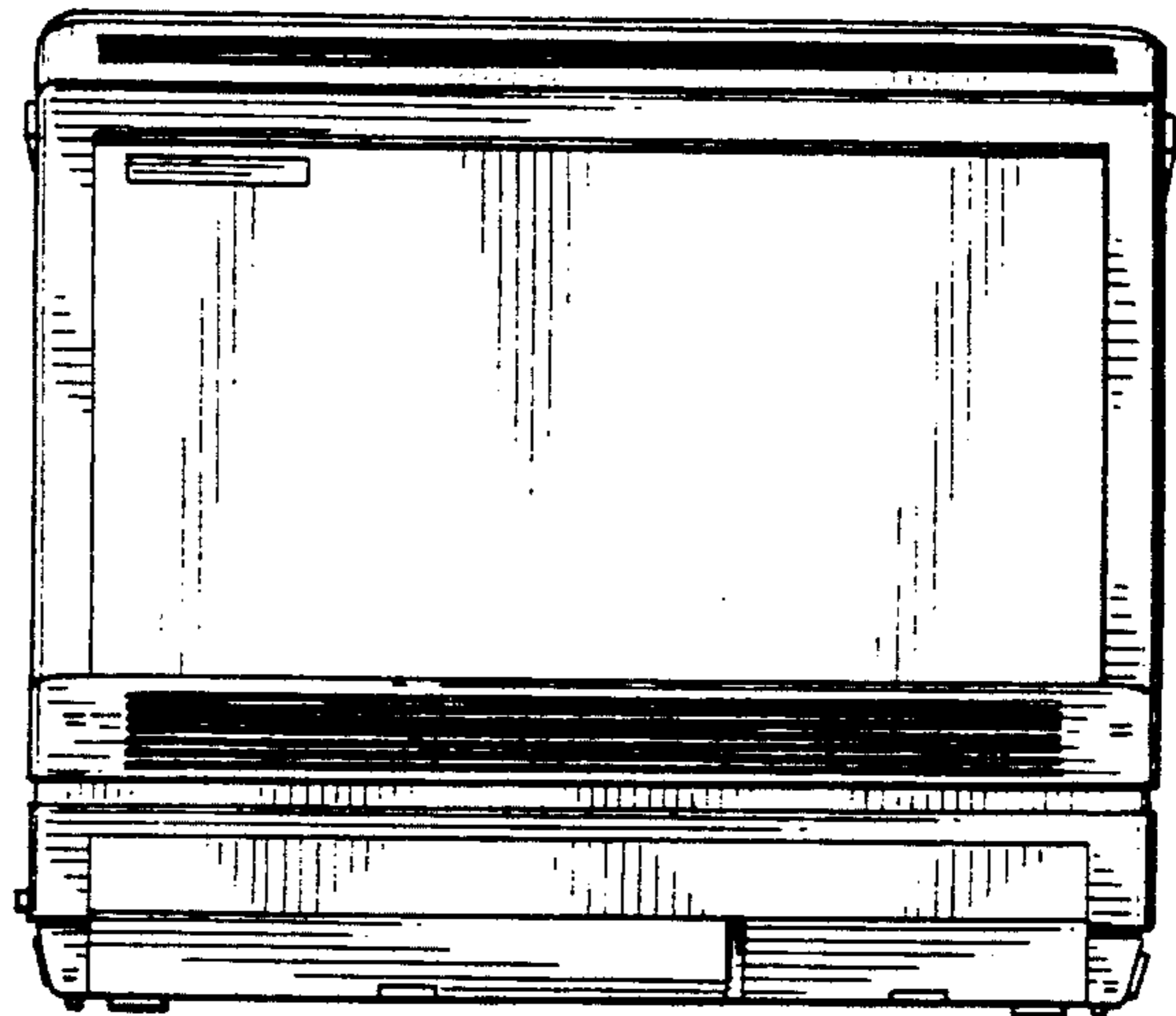

FIG. 2

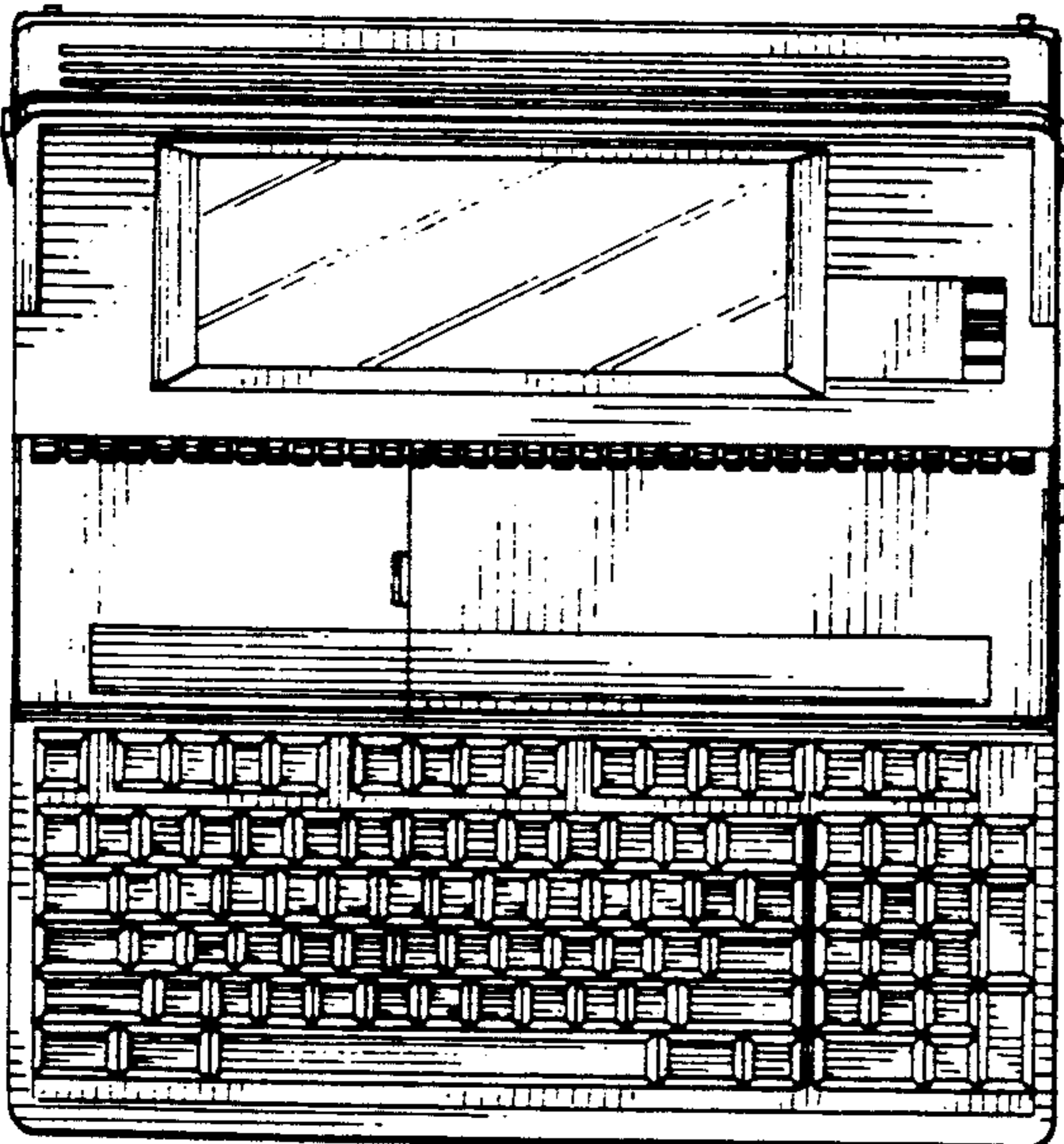

FIG. 3

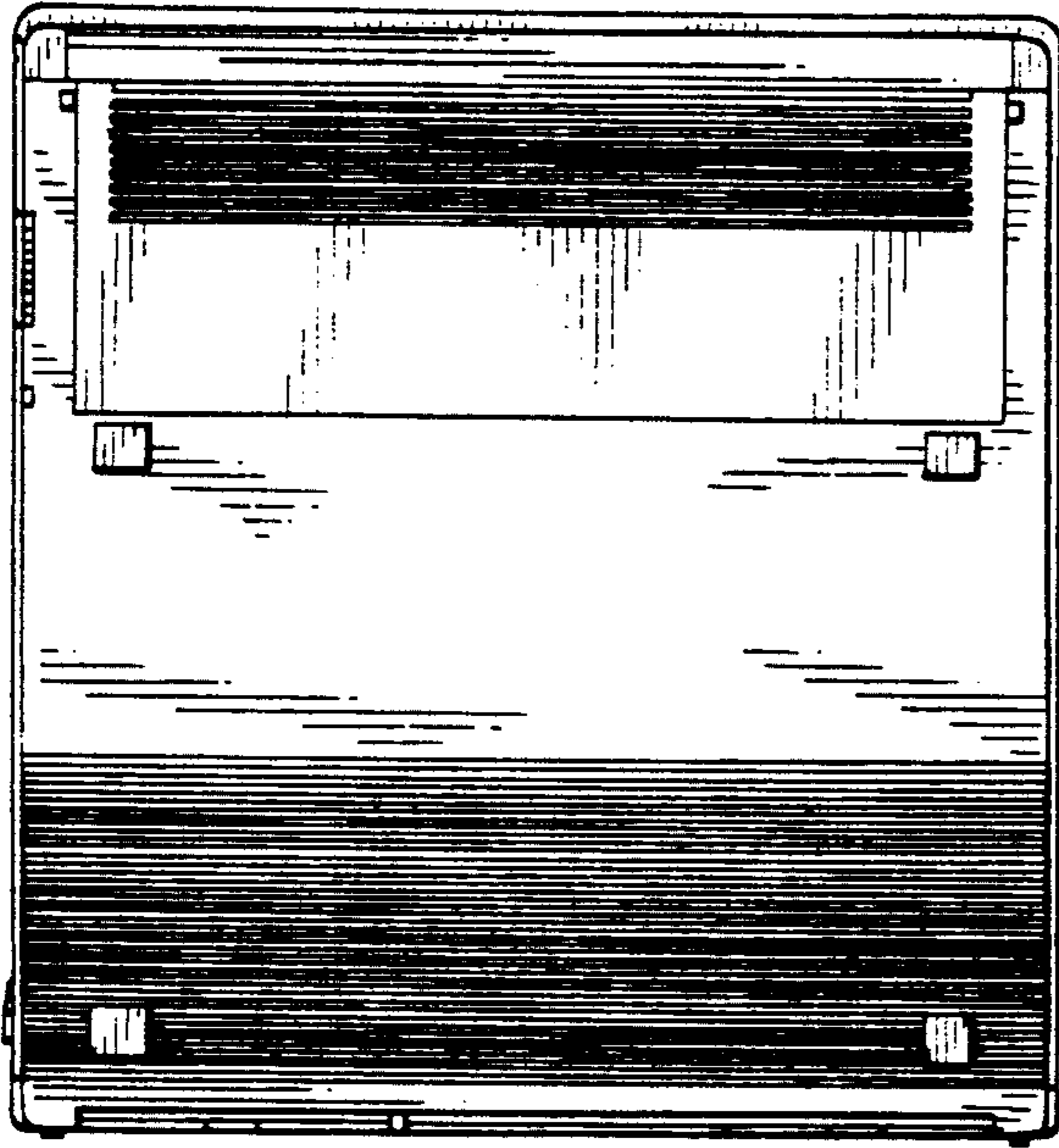

FIG. 4

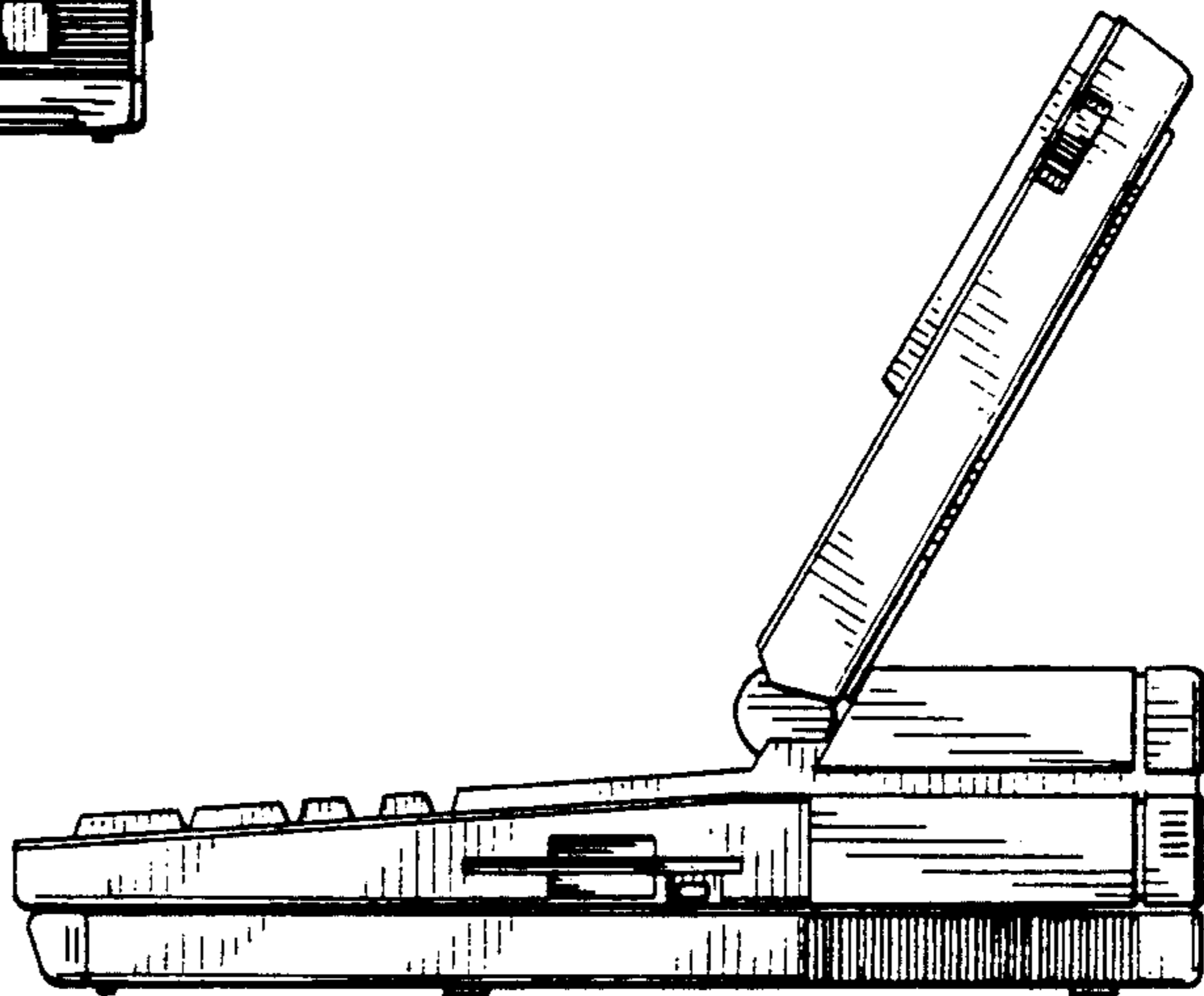

FIG. 5

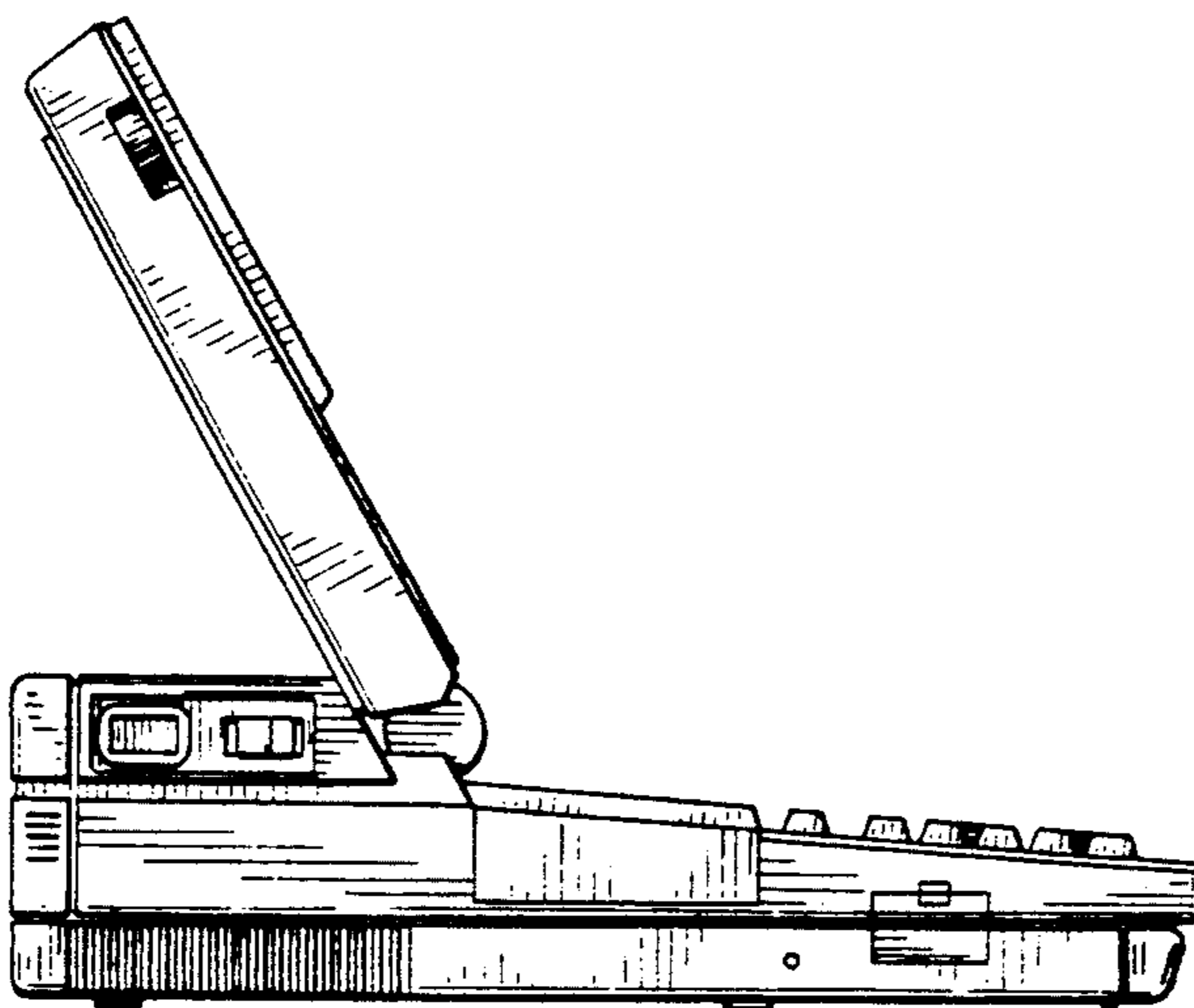

FIG. 6

FIG. 7

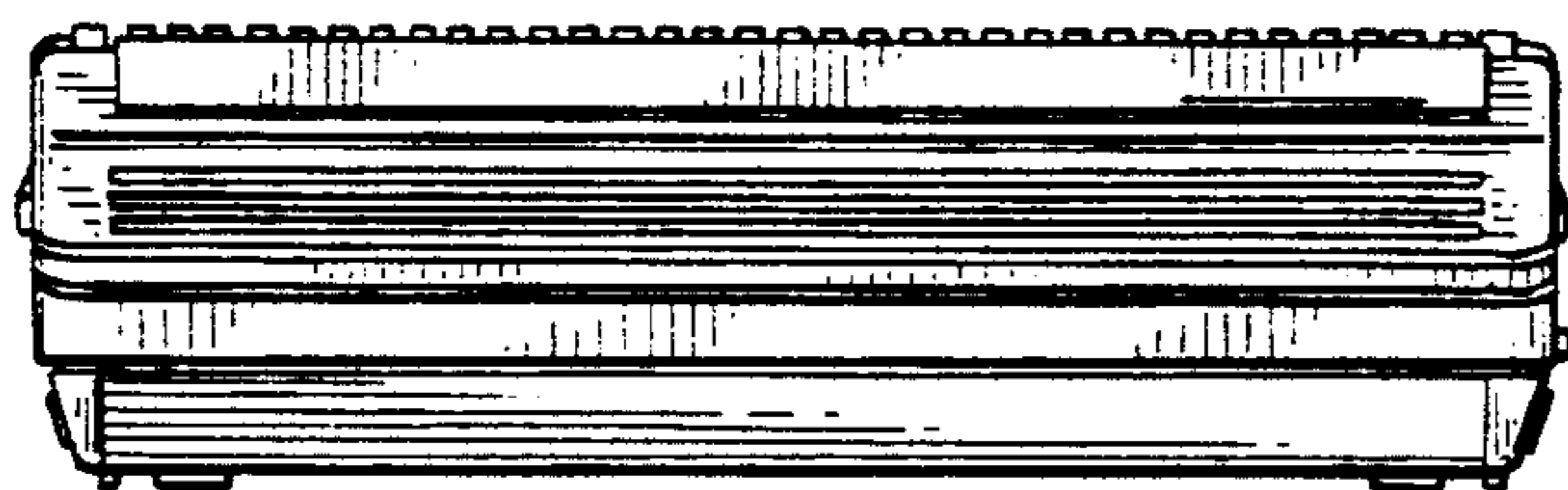
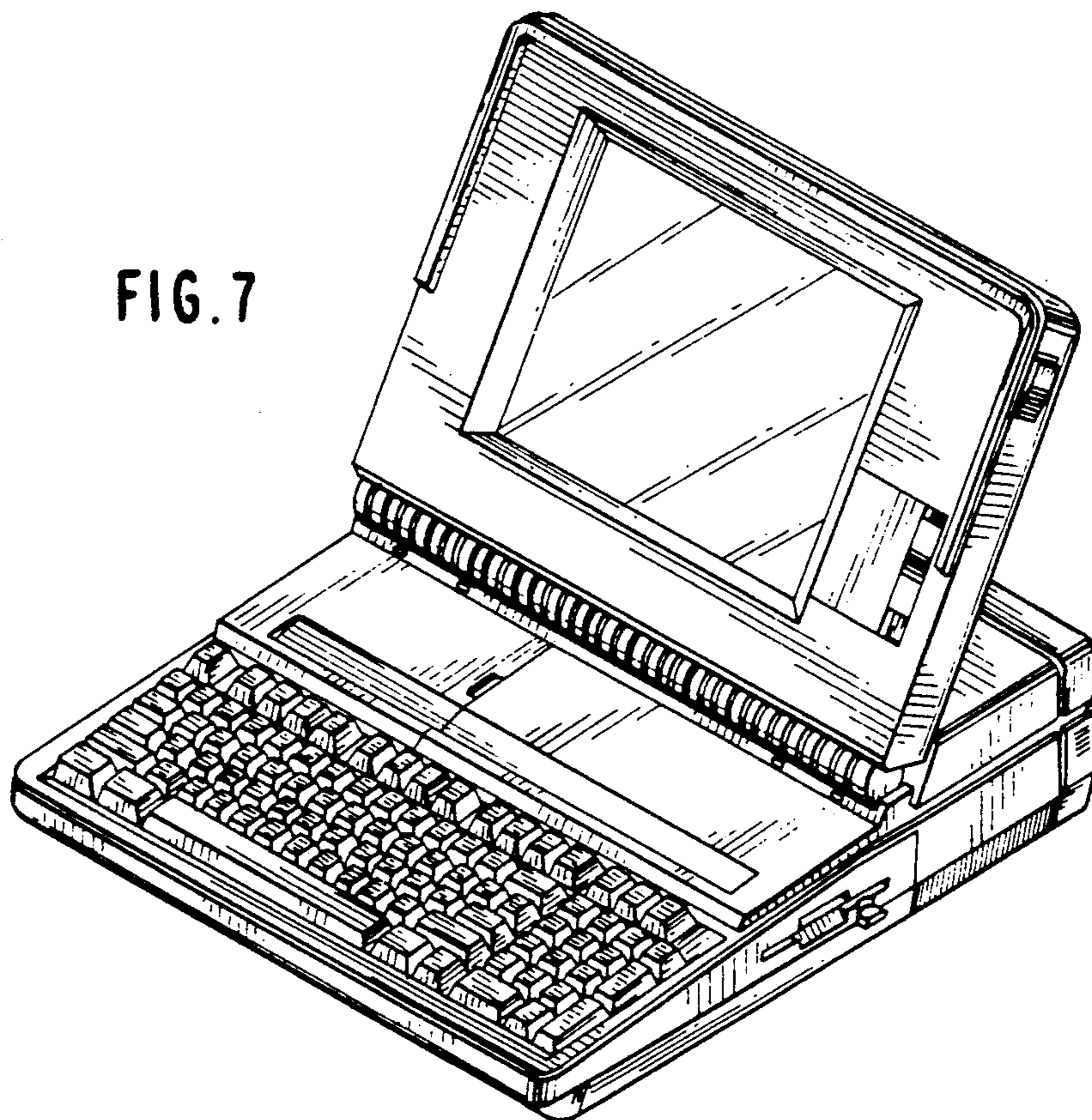
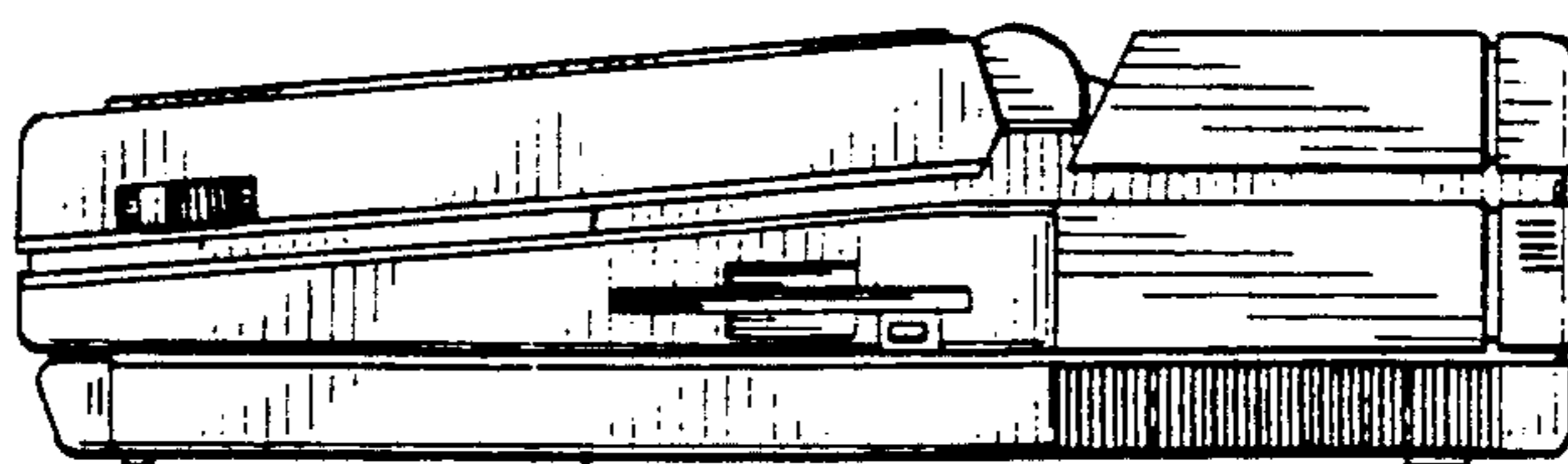

FIG. 8

FIG. 9



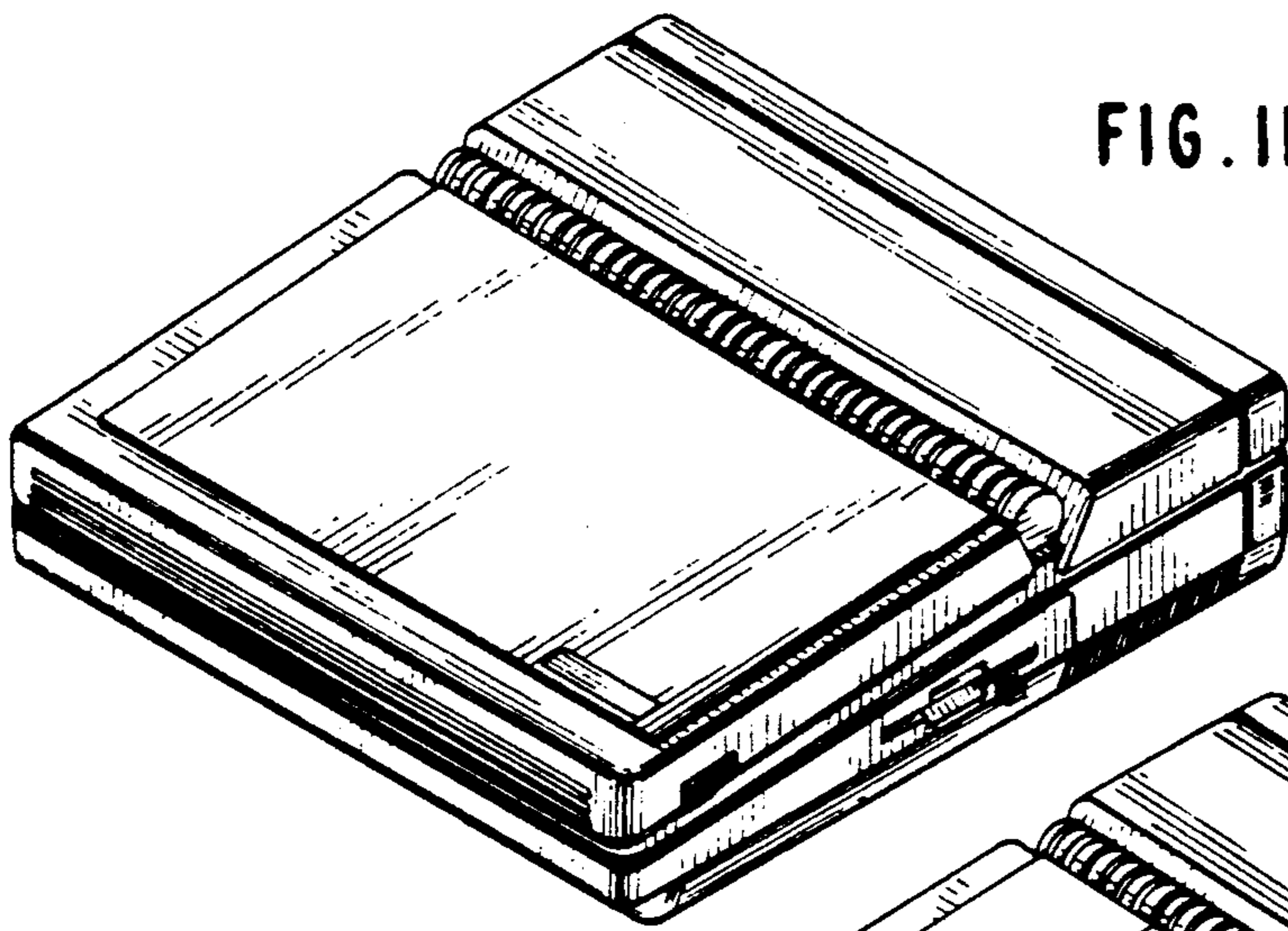

FIG. 11

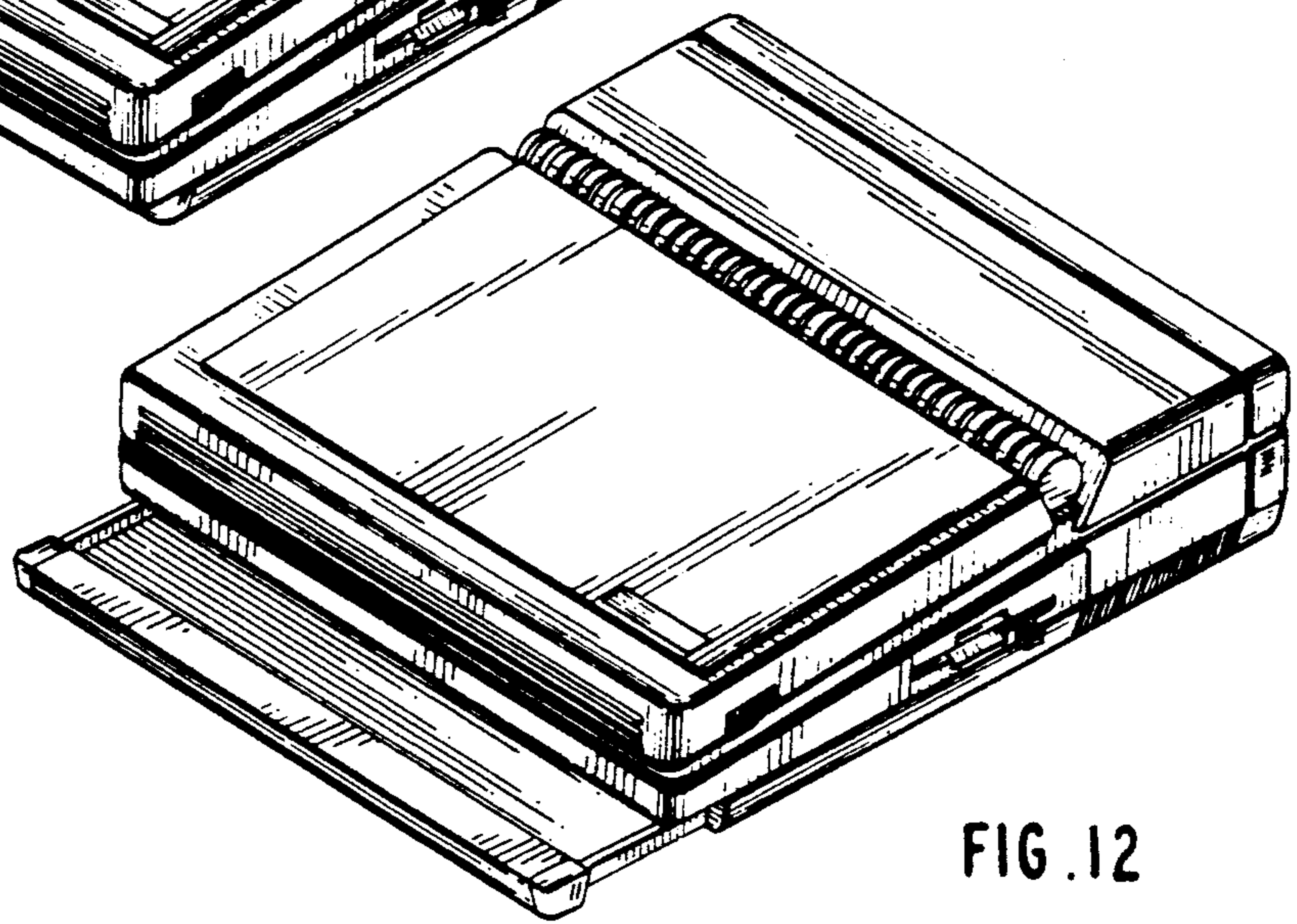

FIG. 12

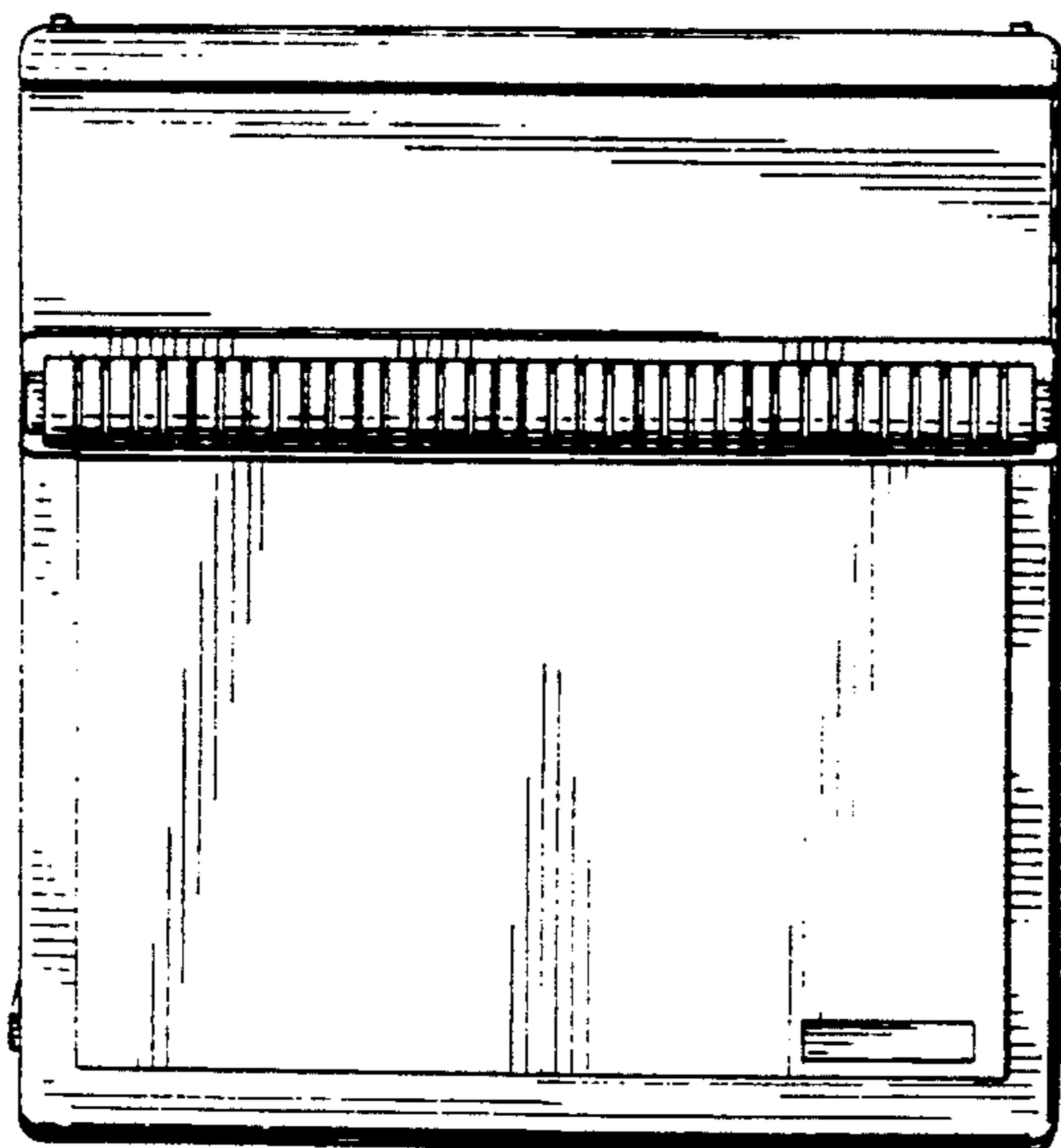

FIG. 10