



US00D341577S

United States Patent [19]

Sugihara et al.

[11] Patent Number: **Des. 341,577**

[45] Date of Patent: **** Nov. 23, 1993**

[54] **PORTABLE LAPTOP COMPUTER**

[75] Inventors: **Shinichi Sugihara; Tetsuya Imamura; Masahiko Moriwaki**, all of Osaka; **Masaru Tochishita**, Hyogo, all of Japan

[73] Assignee: **Matsushita Electric Industrial Co., Ltd.**, Osaka, Japan

[**] Term: **14 Years**

[21] Appl. No.: **831,290**

[22] Filed: **Feb. 6, 1992**

[30] **Foreign Application Priority Data**

Aug. 21, 1991 [JP] Japan 3-25121[U]
[52] U.S. Cl. **D14/106**
[58] Field of Search D14/100, 101, 106, 113, D14/115; D18/1, 7, 11, 12; 235/145 A, 145 R; 340/700, 706; 341/22, 23; 361/390, 394; 364/708, 709.04

[56] **References Cited**

U.S. PATENT DOCUMENTS

D. 324,674 3/1992 Iino D14/106
D. 331,919 12/1992 Sekino et al. D14/106
D. 332,781 1/1993 Toedter D14/106

D. 332,782 1/1993 Kikuchi et al. D14/106
D. 334,558 4/1993 Iino D14/106

Primary Examiner—Wallace R. Burke
Assistant Examiner—Freda S. Nunn
Attorney, Agent, or Firm—Sughrue, Mion, Zinn, Macpeak & Seas

[57] **CLAIM**

The ornamental design for a portable laptop computer, as shown and described.

DESCRIPTION

FIG. 1 is a front top and right side perspective view of a portable laptop computer showing our new design with the keyboard cover and display in the closed position;
FIG. 2 is a front elevational view thereof in the opened position;
FIG. 3 is a rear elevational view thereof;
FIG. 4 is a left side elevational view thereof;
FIG. 5 is a right side elevational view thereof;
FIG. 6 is a top plan view thereof;
FIG. 7 is a bottom plan view thereof;
FIG. 8 is a front top and right side perspective view thereof; and,
FIG. 9 is a rear bottom and left side perspective view thereof.

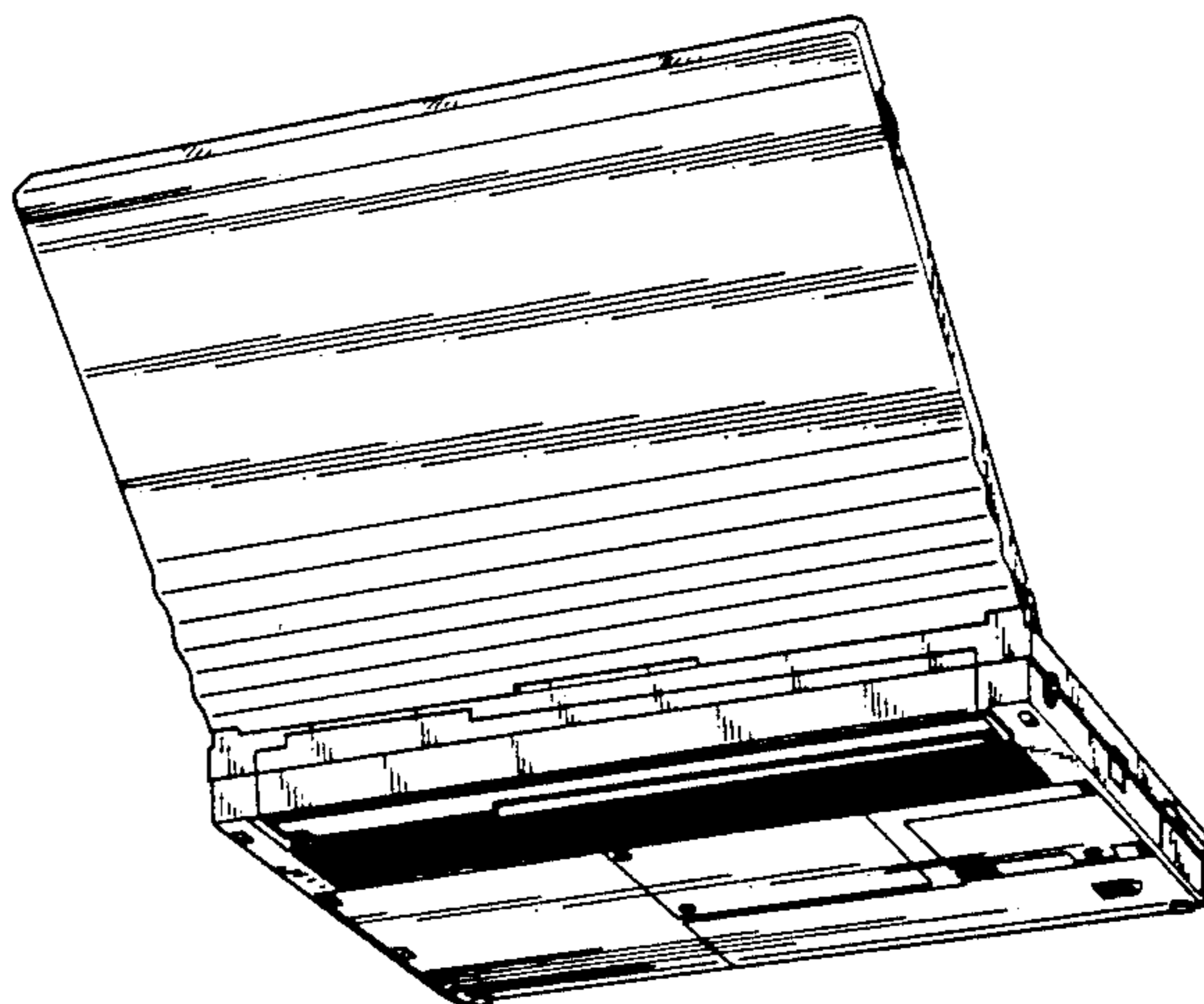
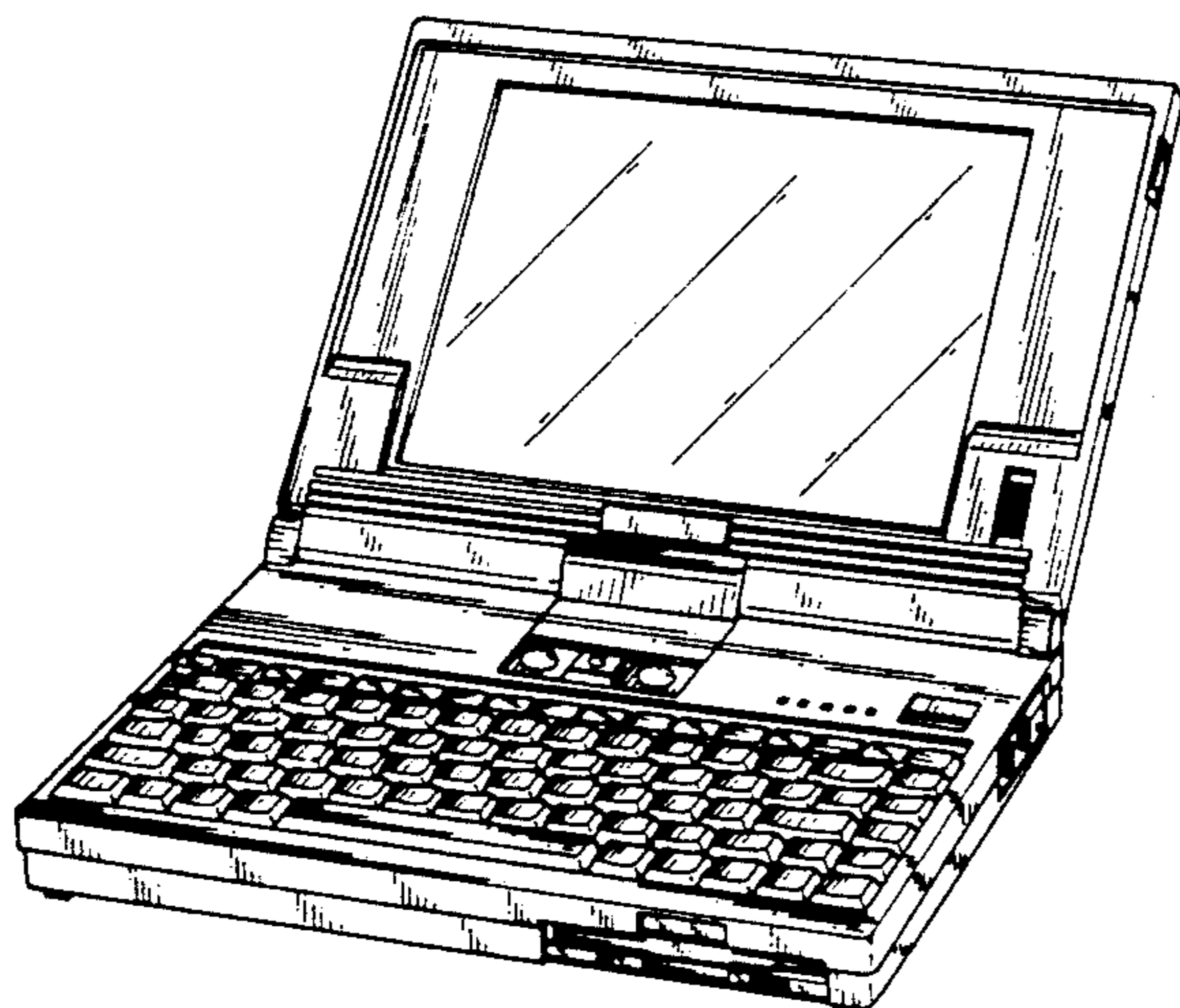

Fig. 1

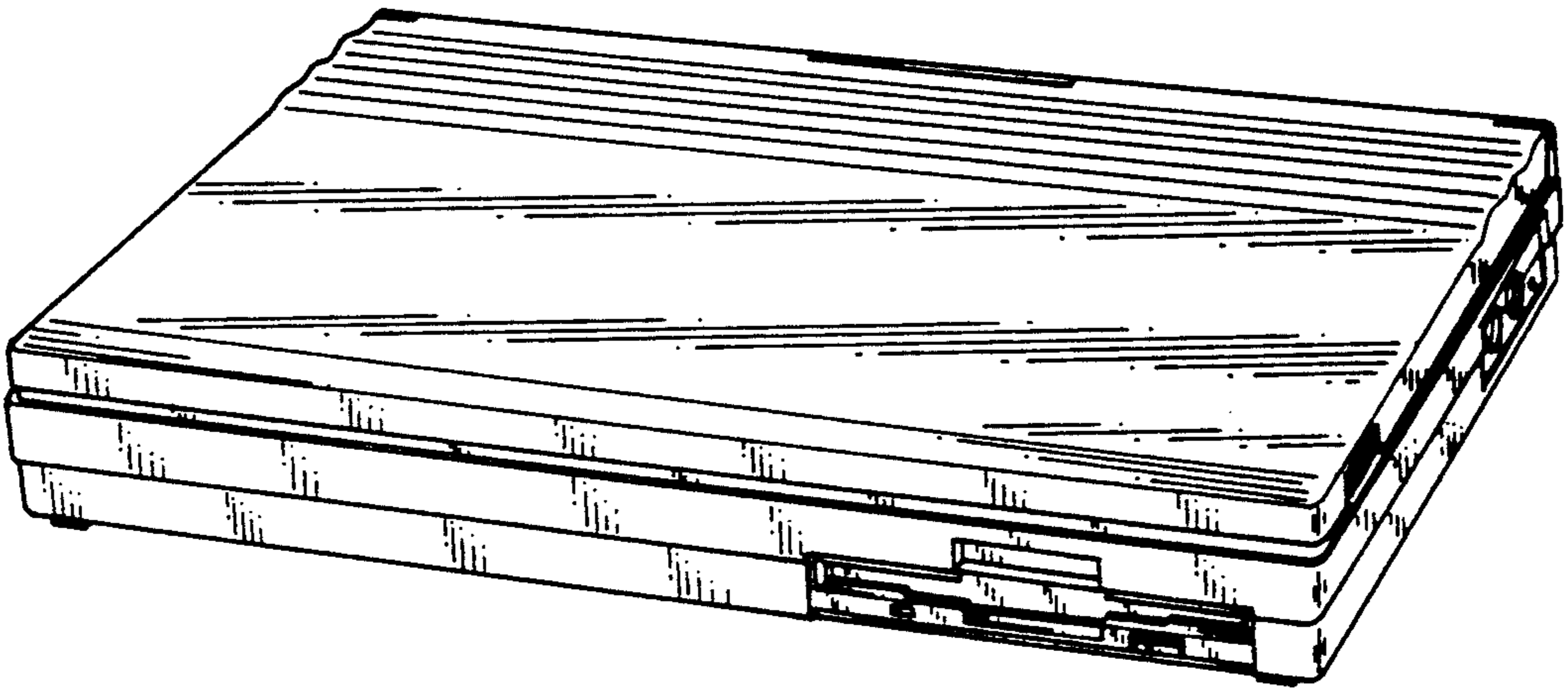

Fig. 2

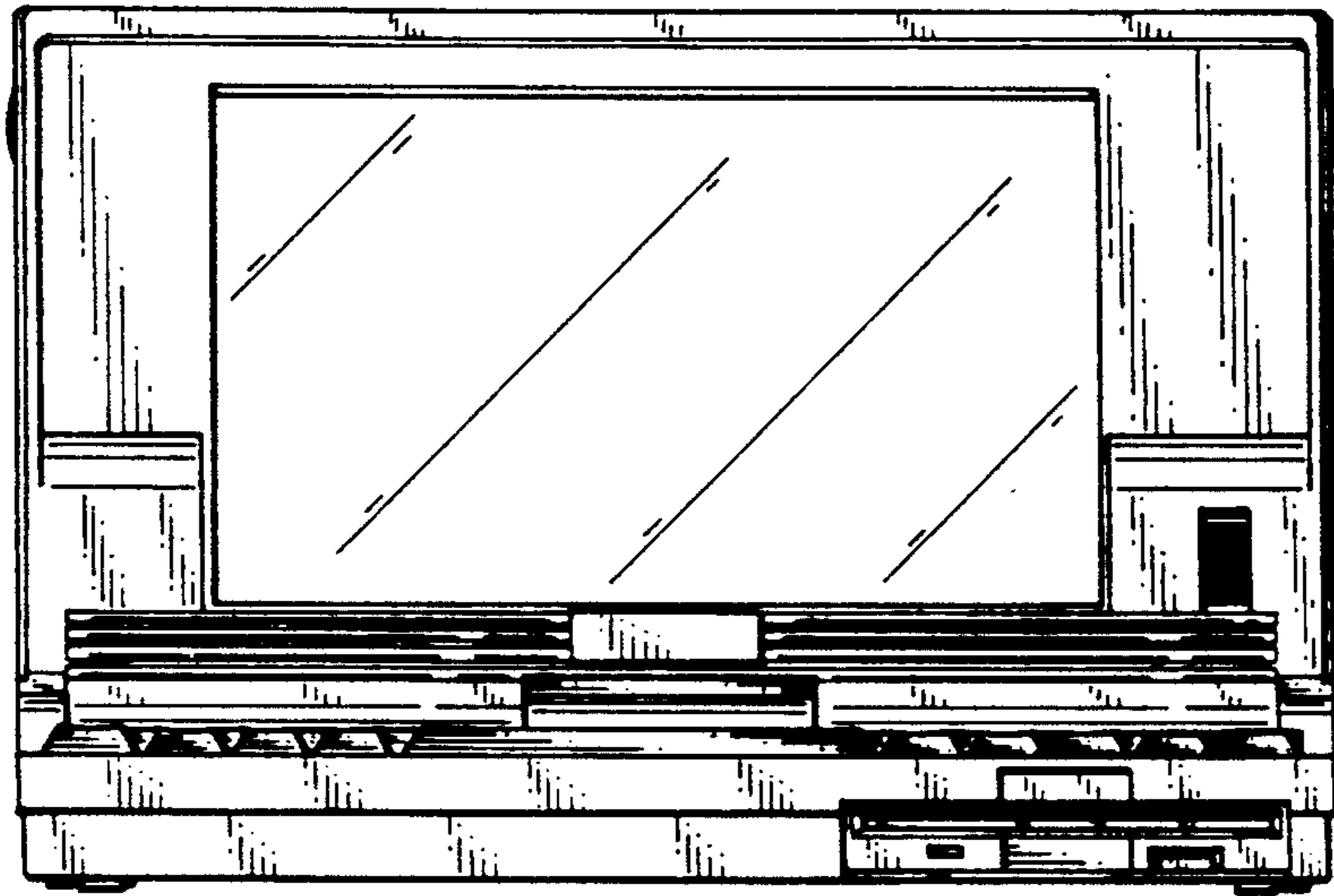

Fig. 3

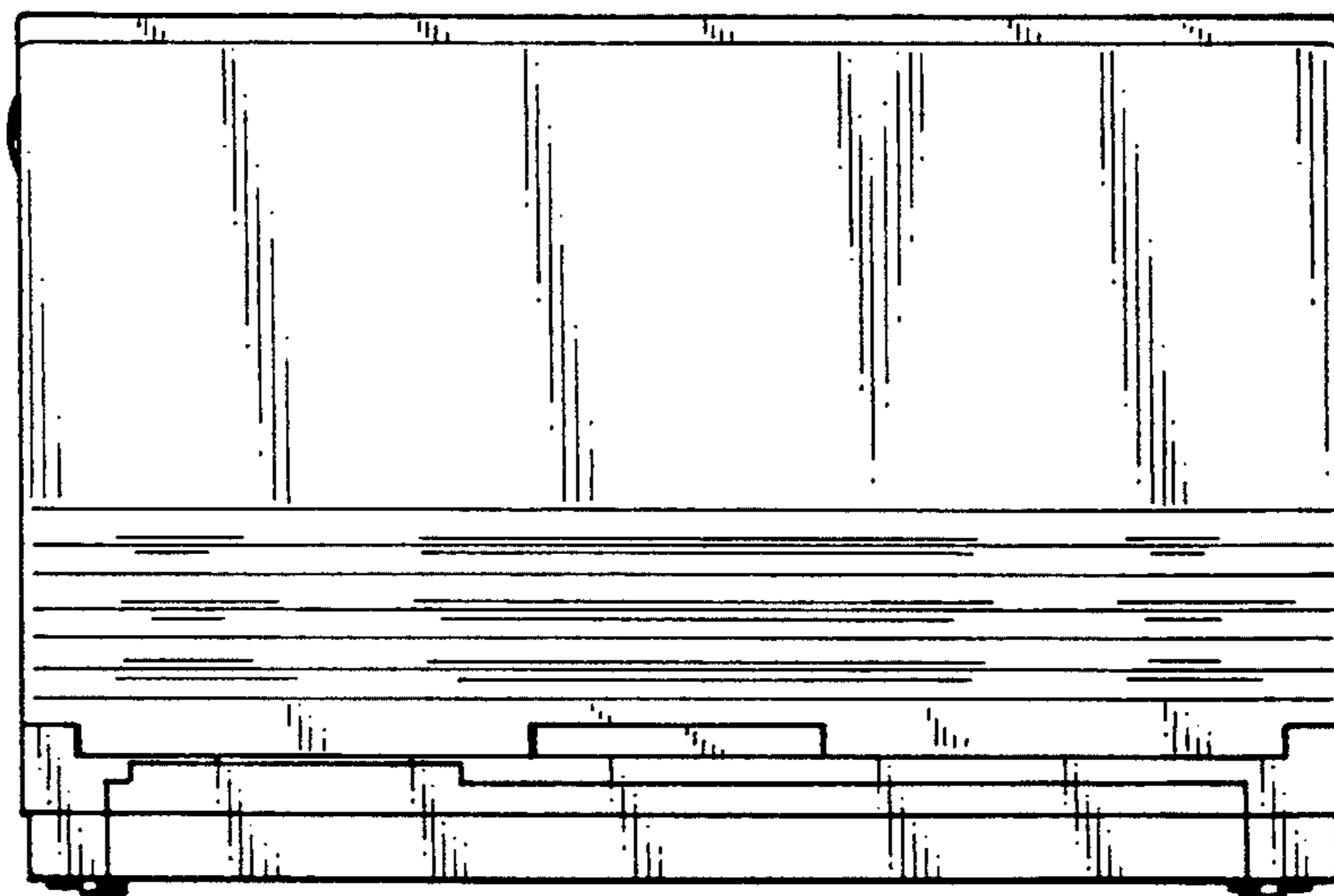

Fig. 4

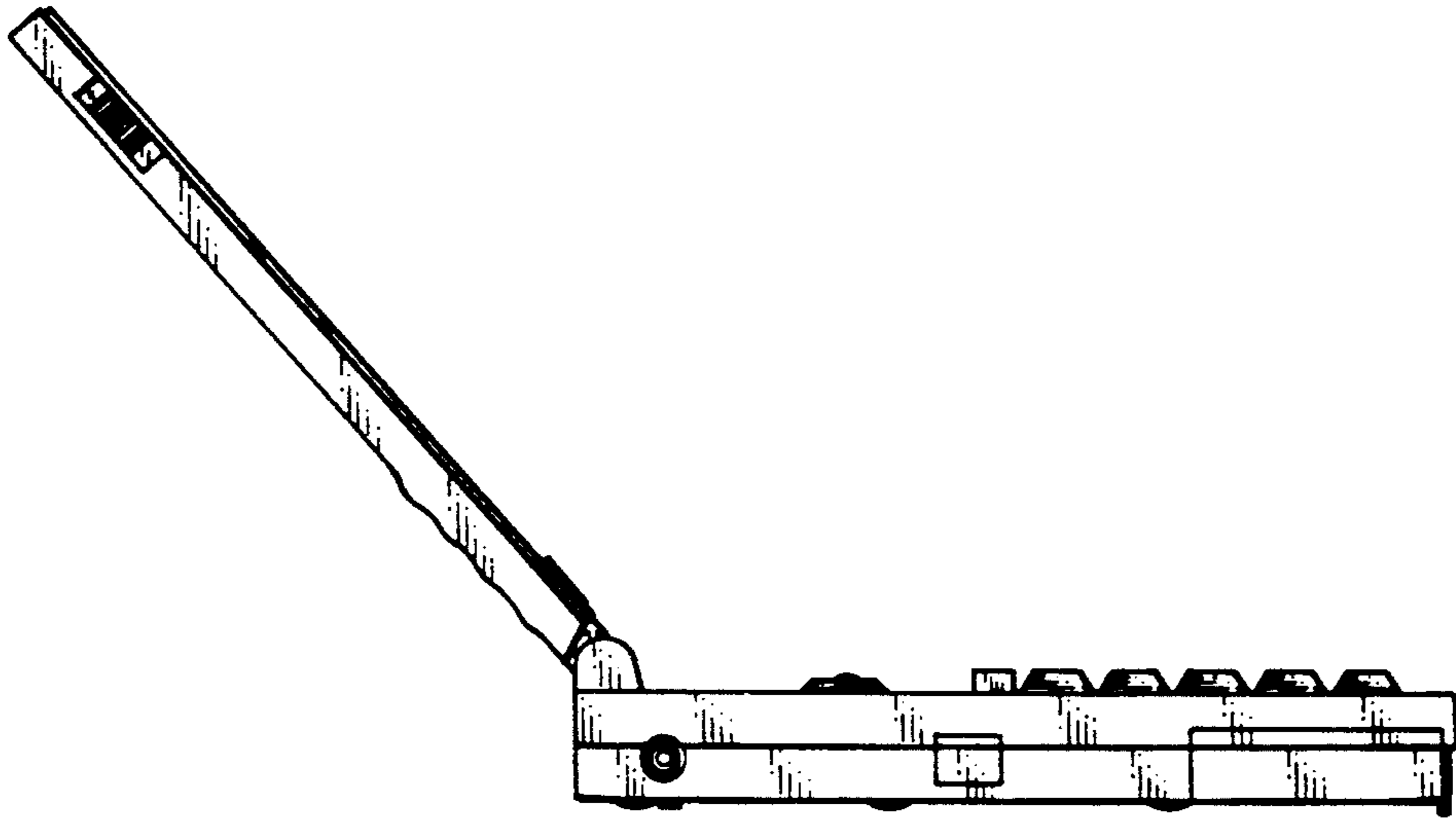

Fig. 5

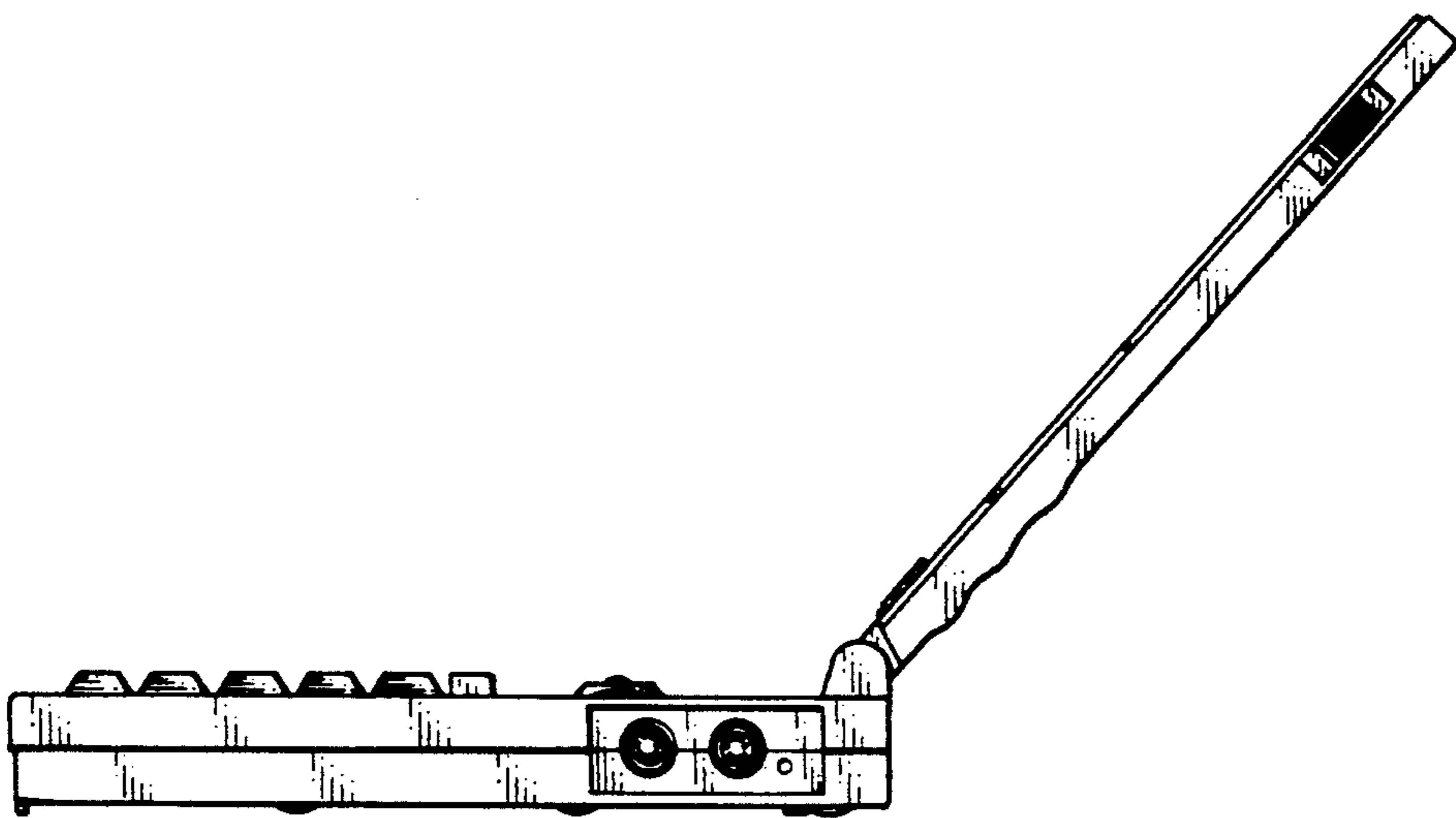

Fig. 6

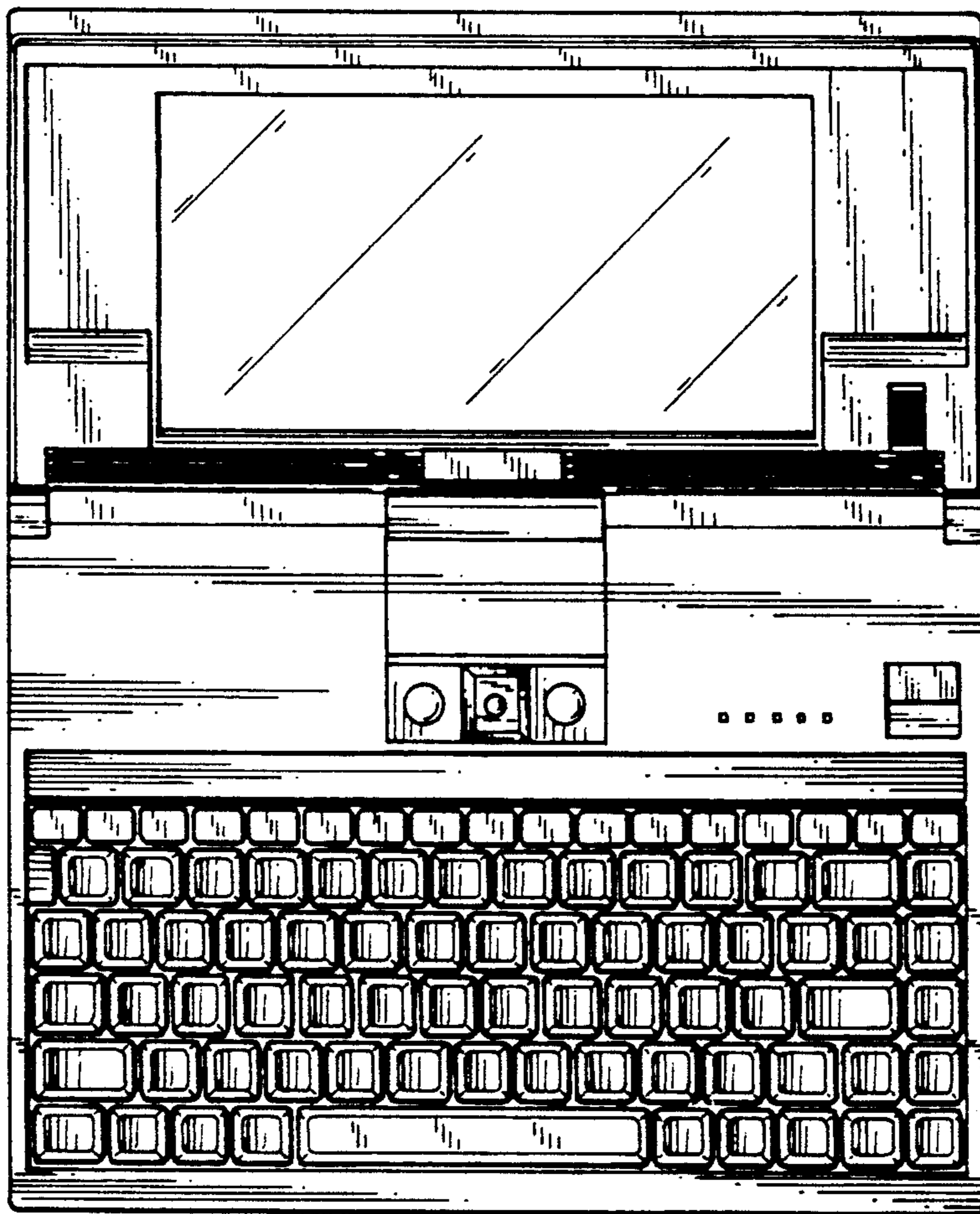

Fig. 7

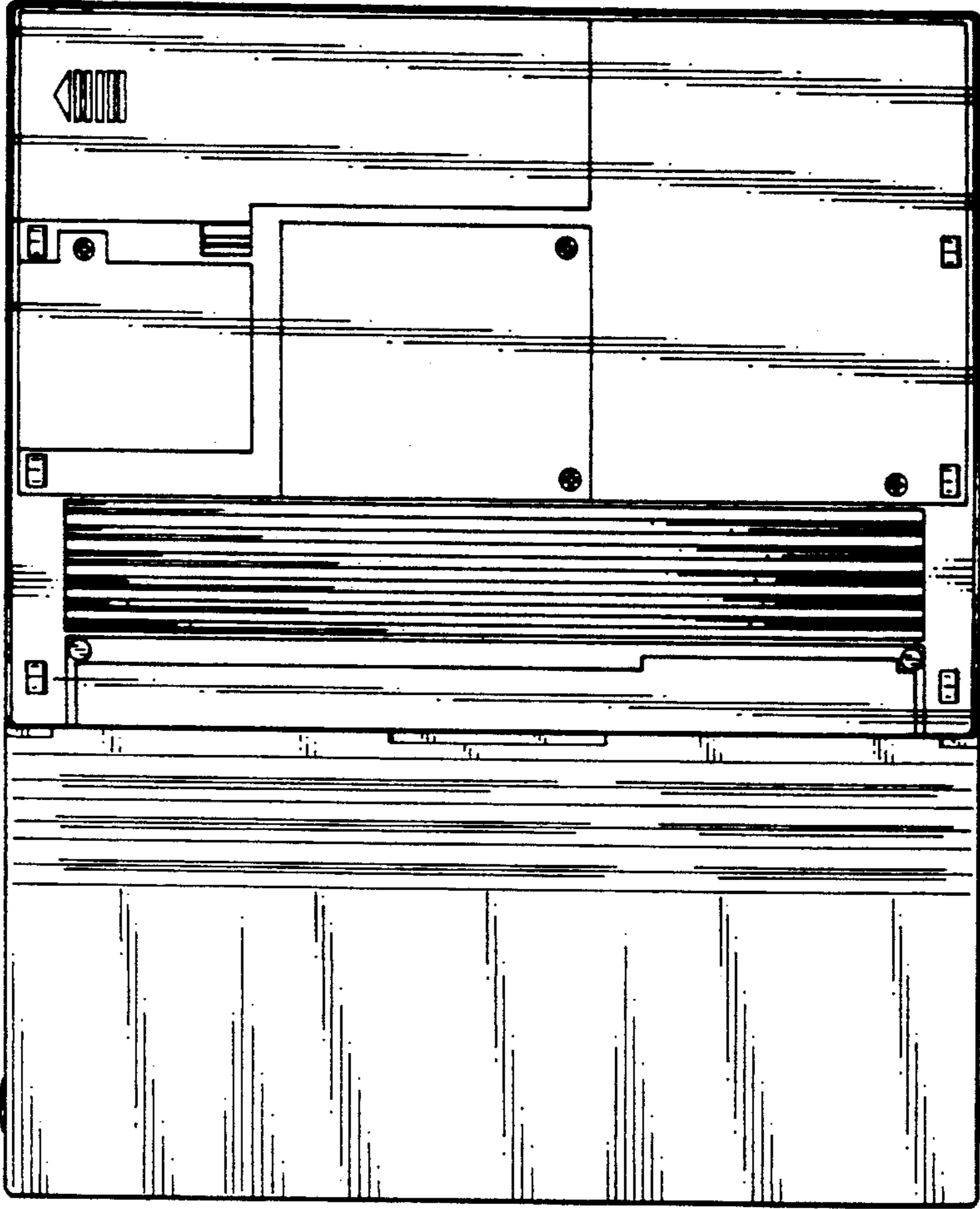

Fig. 8

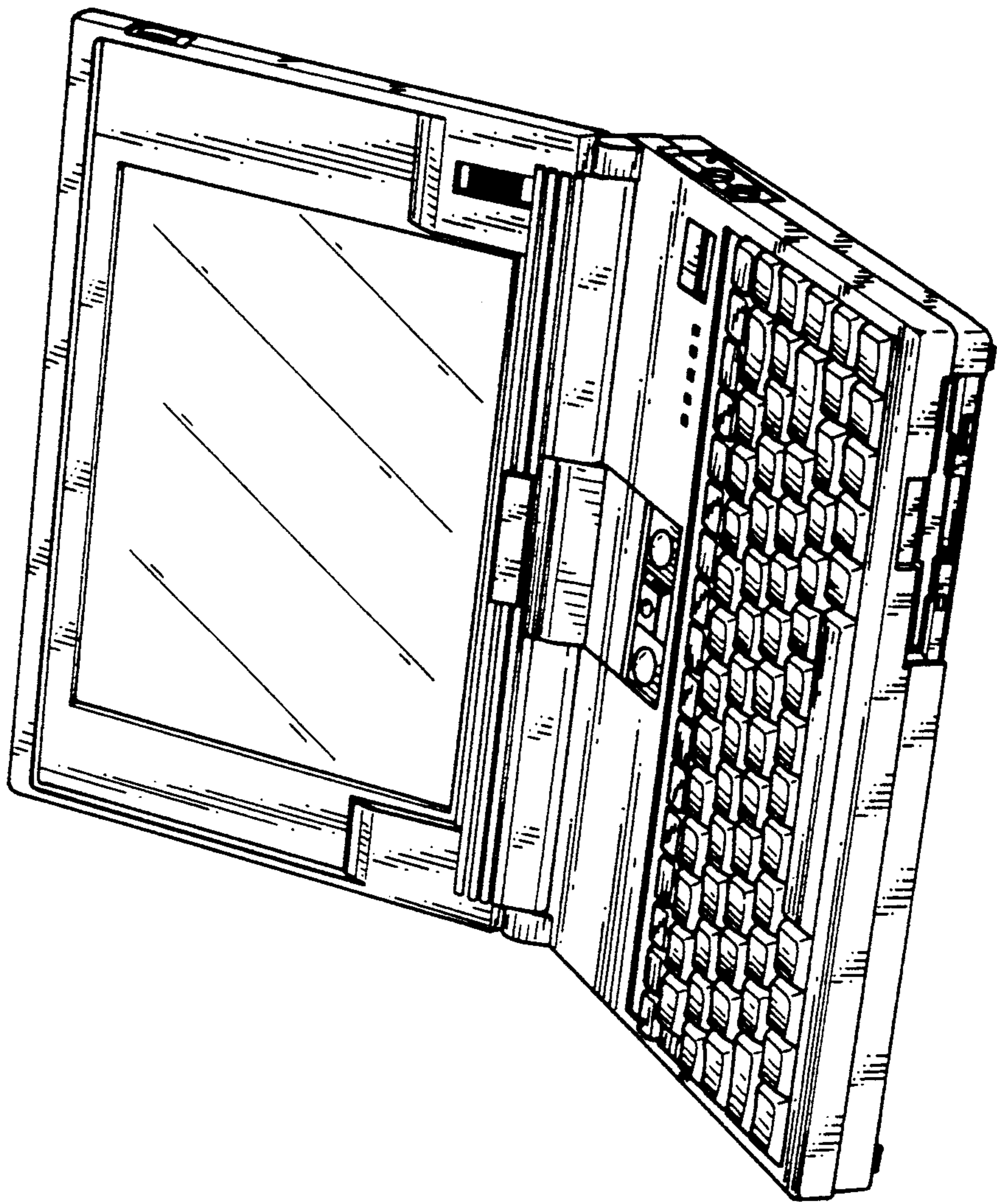

Fig. 9

