

[54] STEREO STAND

[76] Inventor: **Miranda Leonard**, Church Court Condominiums, 492 Beacon St., Boston, Mass. 02115

[**] Term: **14 Years**

[21] Appl. No.: **738,942**

[22] Filed: **Aug. 1, 1991**

[52] U.S. Cl. **D6/467; D6/407; D6/477**

[58] Field of Search **D6/407, 470, 429-431, D6/457, 461, 466-468, 474, 477-479; 211/13, 131, 163, 133, 186-188; 108/106-108, 111; 248/676**

[56] **References Cited**

U.S. PATENT DOCUMENTS

D. 55,045	5/1920	Howard	D6/407
D. 230,545	3/1974	Mouchon	D6/470
D. 235,597	7/1975	Loomis	D6/479
D. 254,828	4/1980	Kates	D6/461
D. 286,115	10/1986	Evans	D6/474 X
D. 289,114	4/1987	Dickson	D6/479 X
D. 300,096	3/1989	Galhaud et al.	D6/478
D. 310,310	9/1990	Martinez	D6/461 X

D. 314,296	2/1991	Mason	D6/479
D. 325,482	4/1992	Schwartz	D6/479 X
4,531,645	7/1985	Tisbo et al.	211/163

OTHER PUBLICATIONS

Architectural Forum, Nov. 1953, p. 171, copy in Design Class D6/479.

Primary Examiner—Alan P. Douglas

Assistant Examiner—Jeffrey Asch

Attorney, Agent, or Firm—Townsend & Townsend Khourie & Crew

[57] **CLAIM**

The ornamental design for a stereo stand, as shown and described.

DESCRIPTION

FIG. 1 is a front isometric view of a stereo stand made according to the invention;
 FIG. 2 is a back isometric view thereof;
 FIG. 3 is a top plan view thereof;
 FIG. 4 is a bottom plan view thereof;
 FIG. 5 is a left side elevational view thereof;
 FIG. 6 is a right side elevational view thereof;
 FIG. 7 is a front elevational view thereof; and,
 FIG. 8 is a rear elevational view thereof.

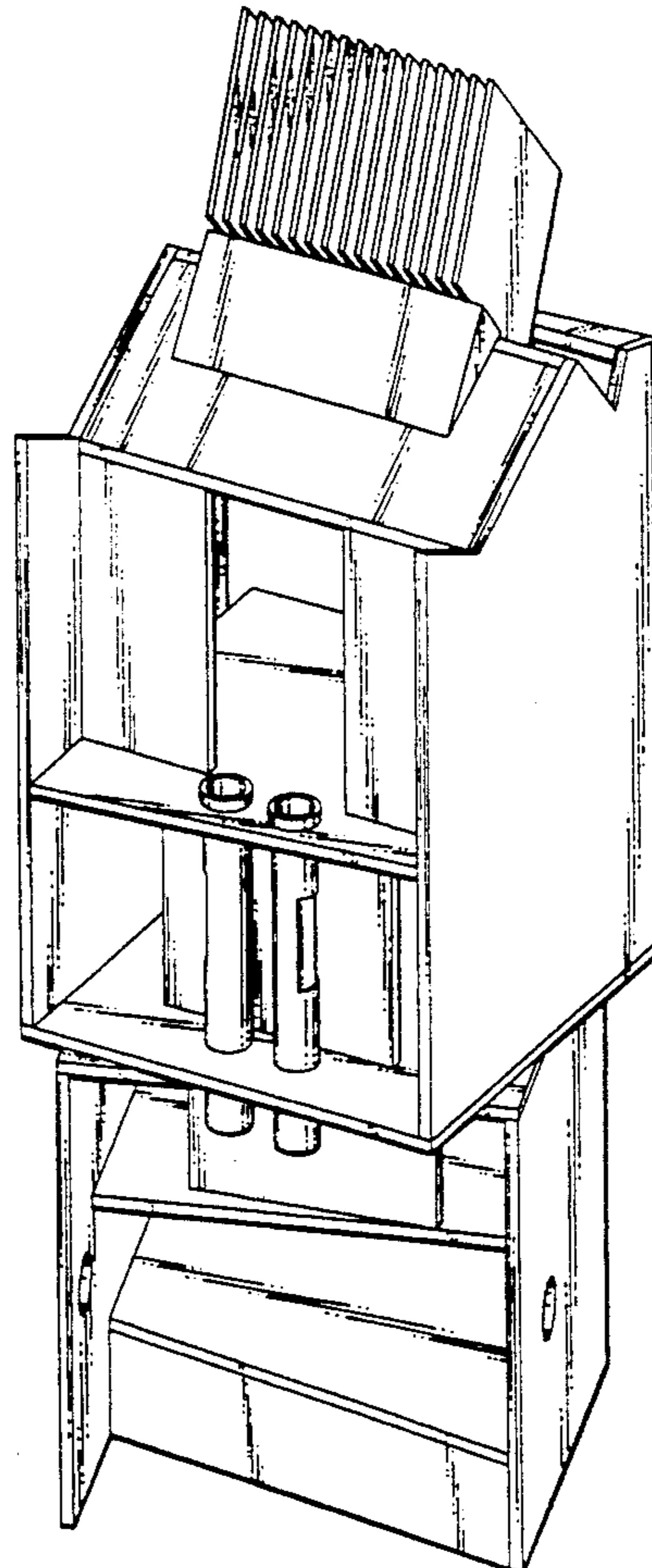
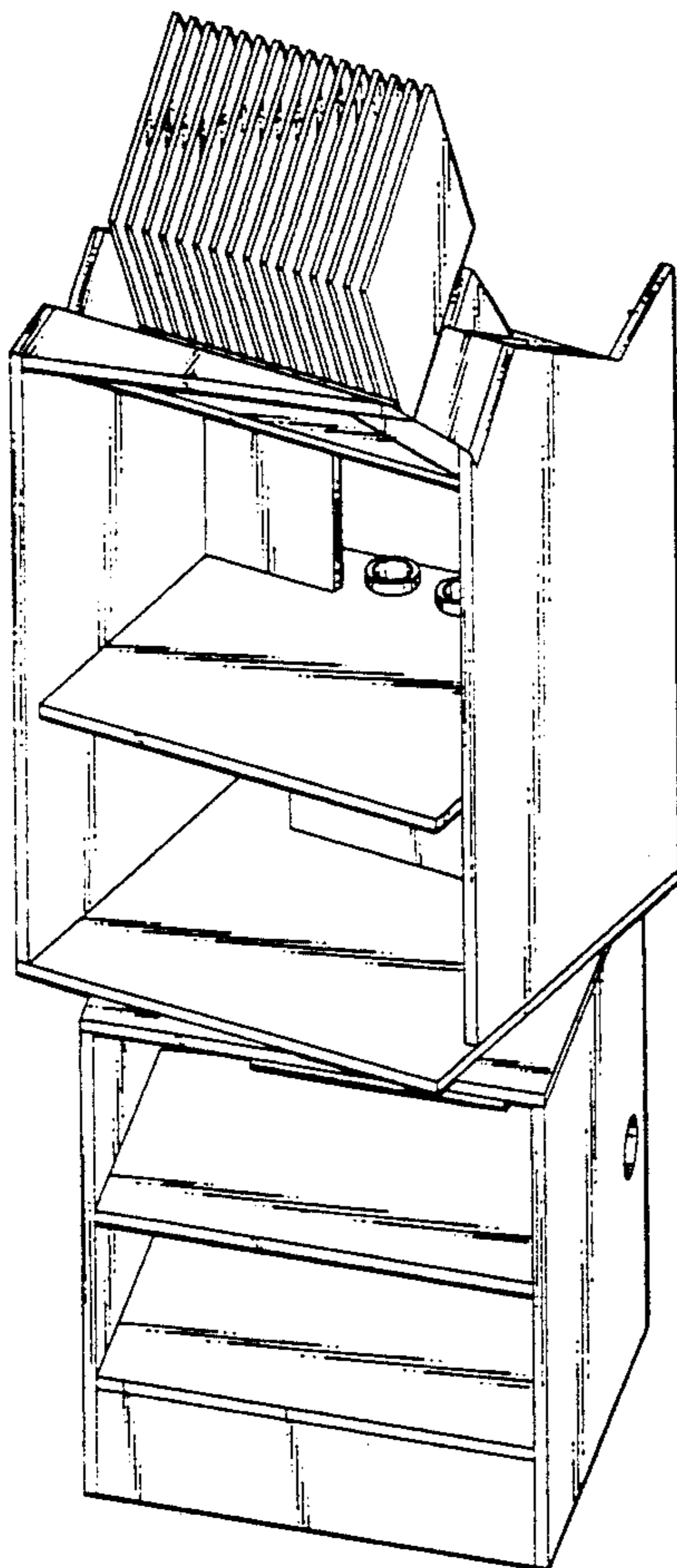

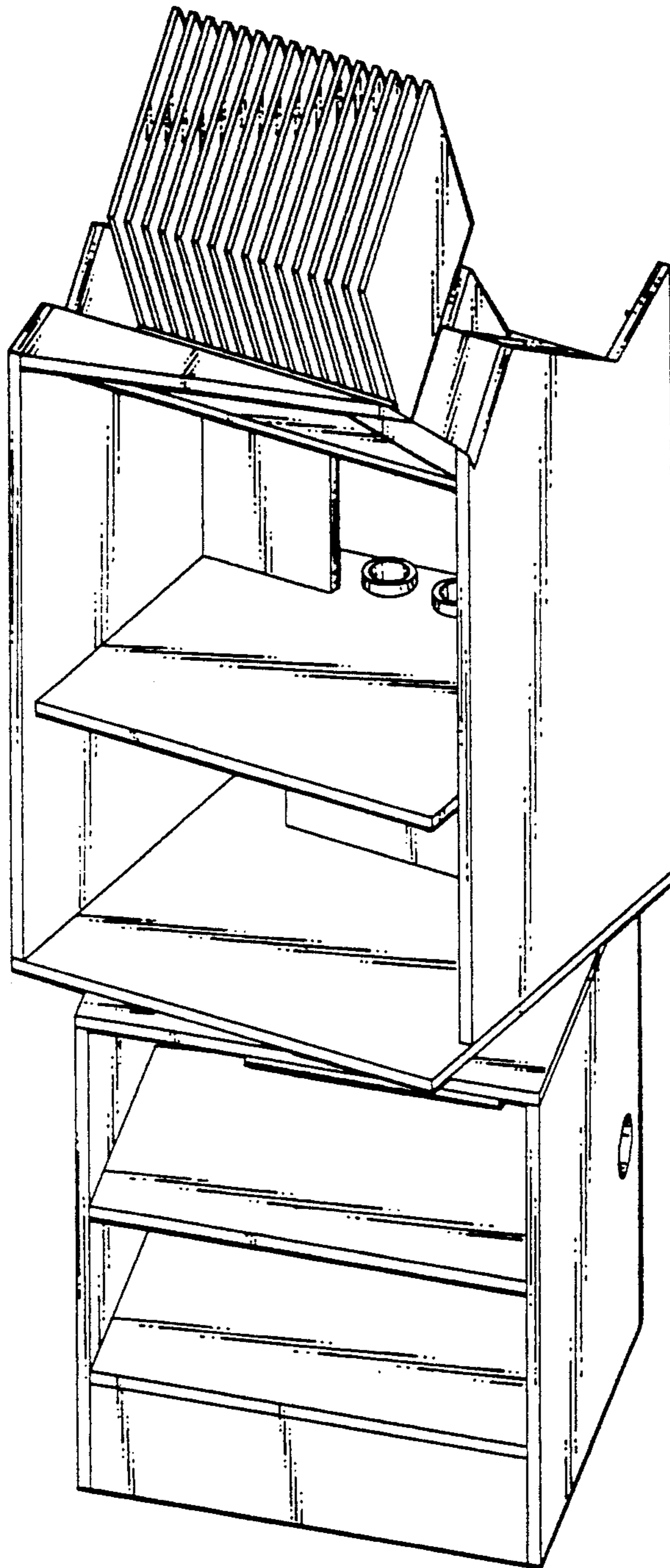

FIGURE 1

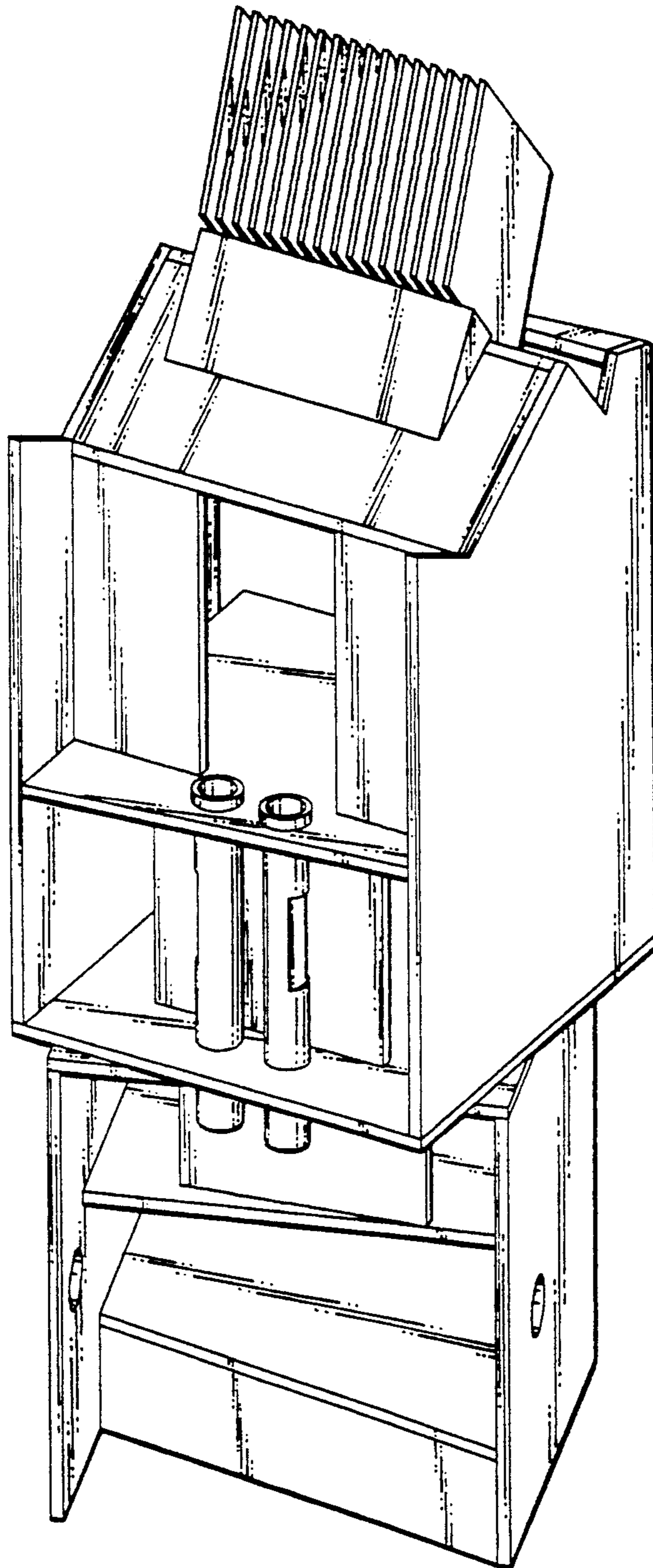

FIGURE 2

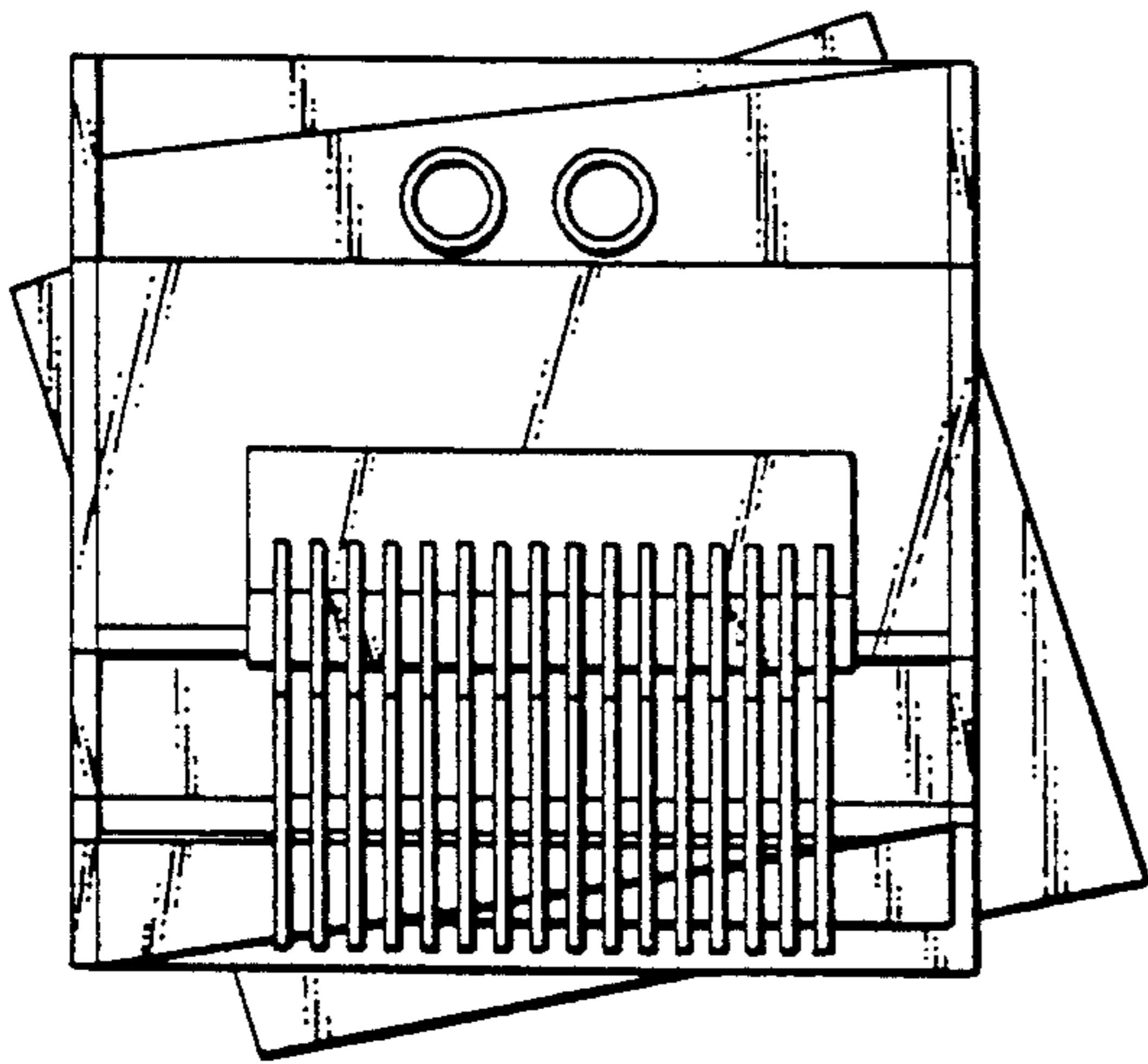

FIGURE 3

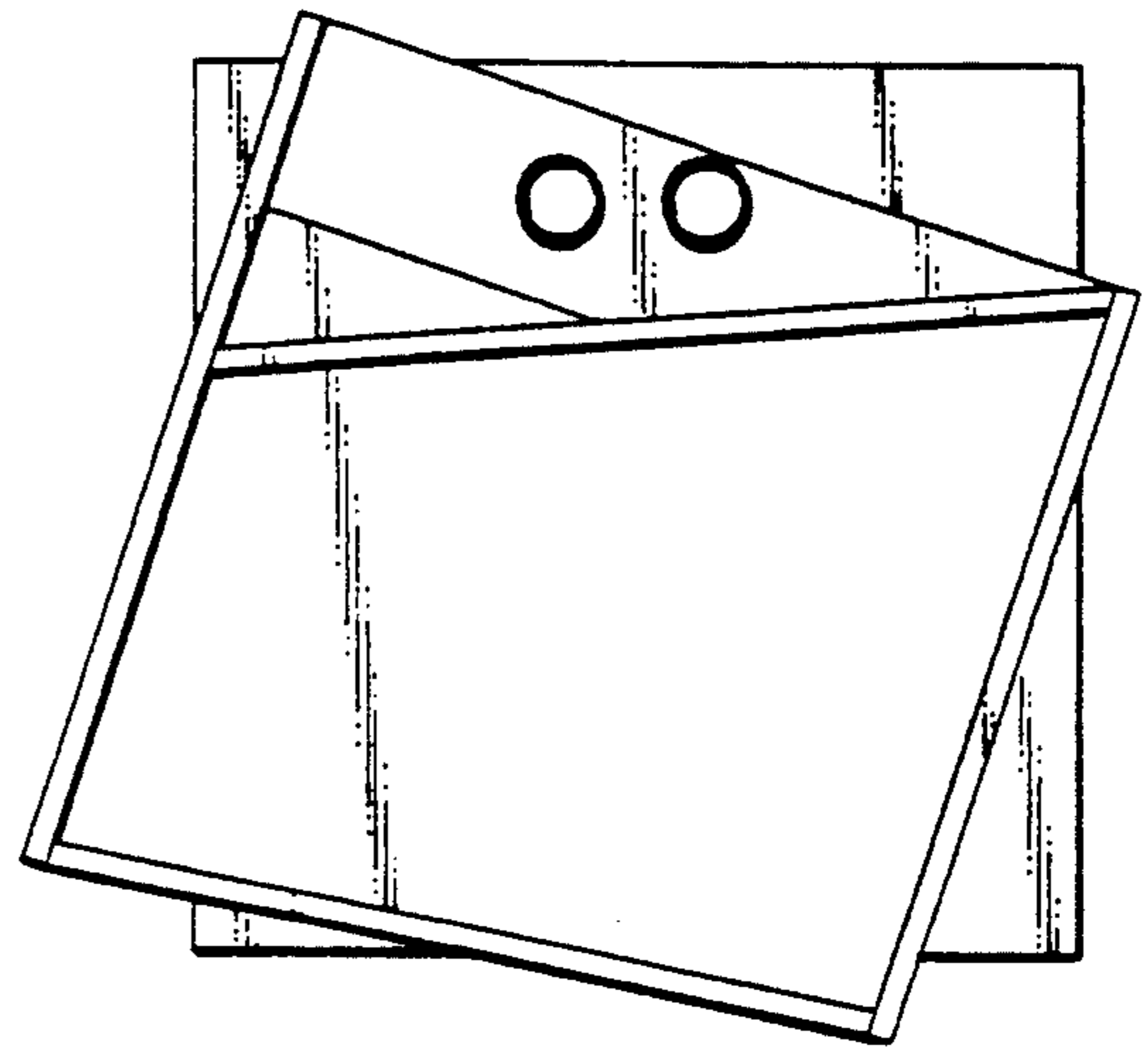

FIGURE 4

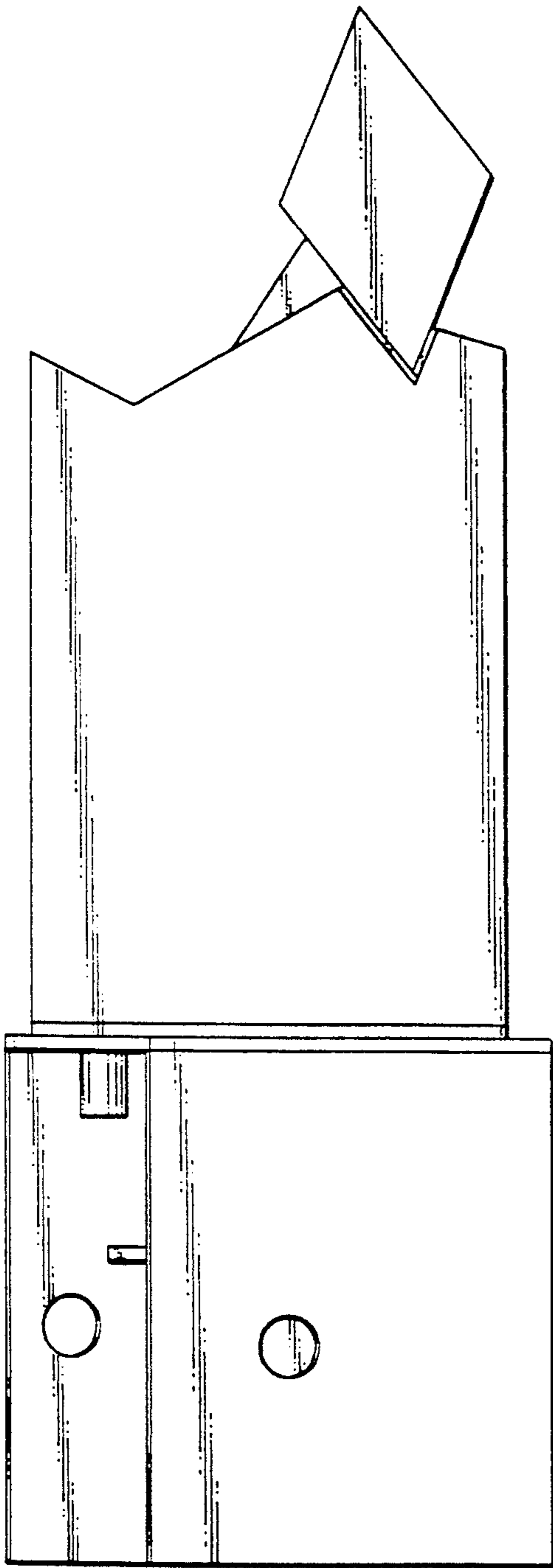

FIGURE 5

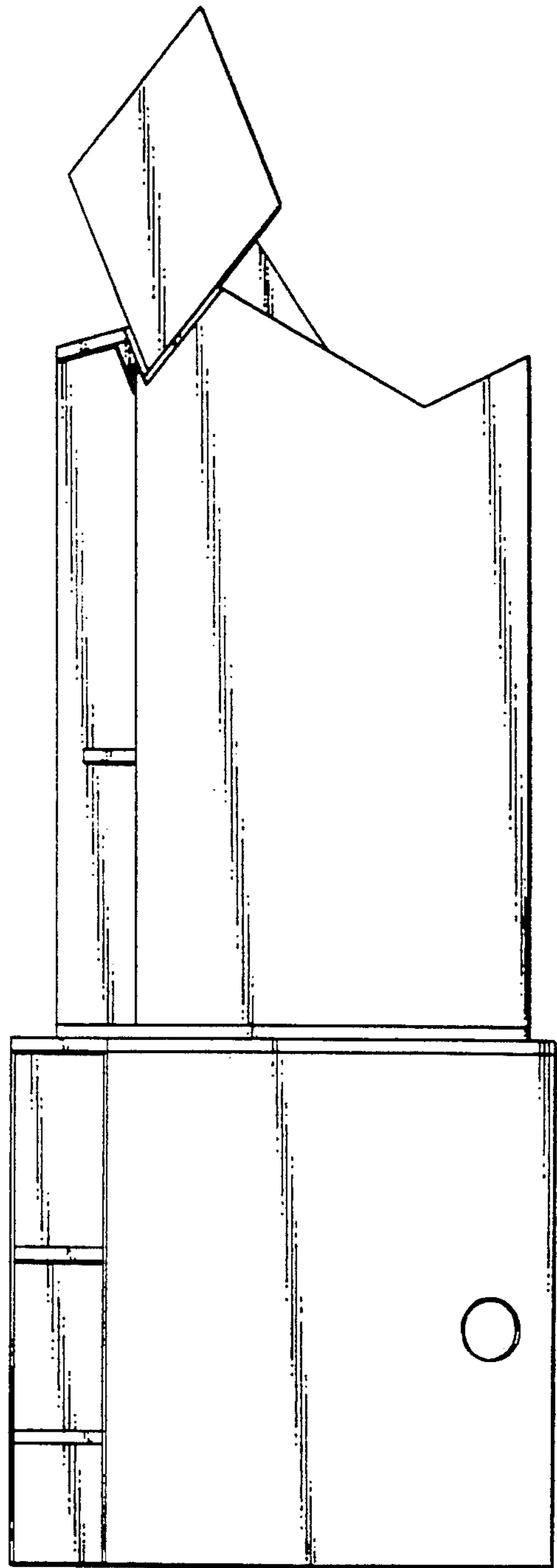

FIGURE 6

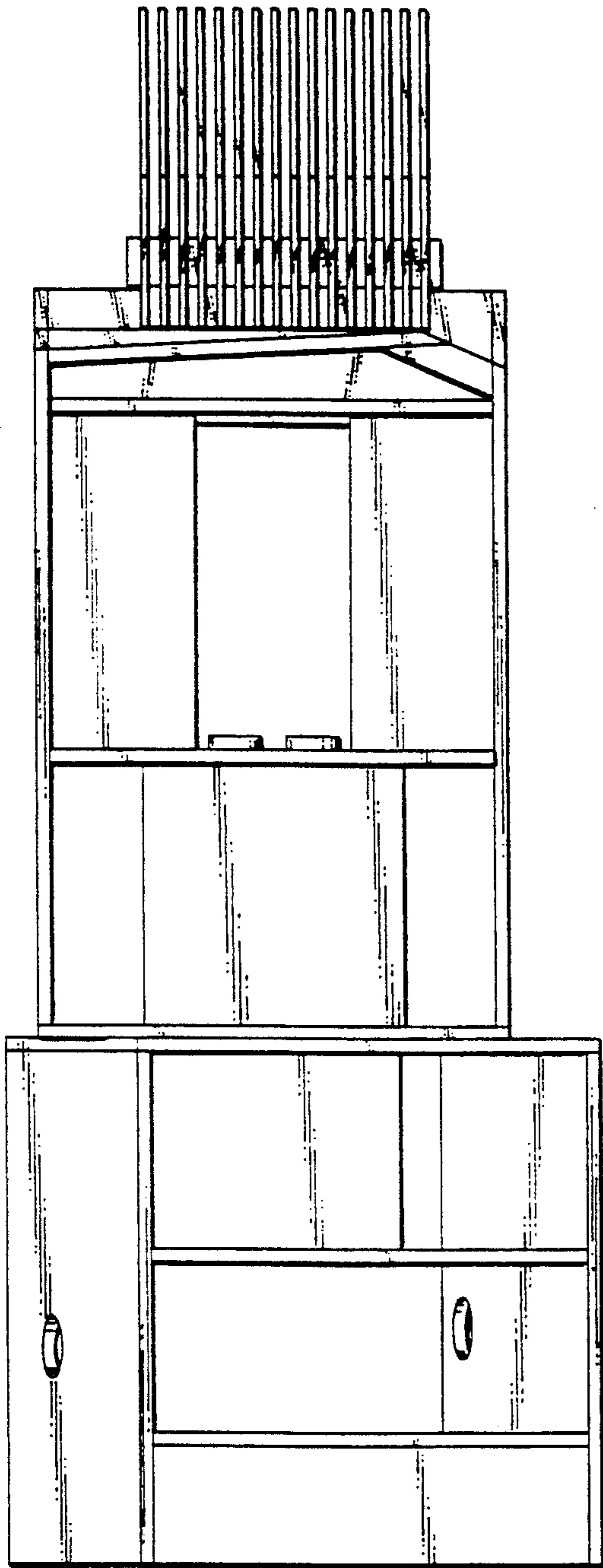

FIGURE 7

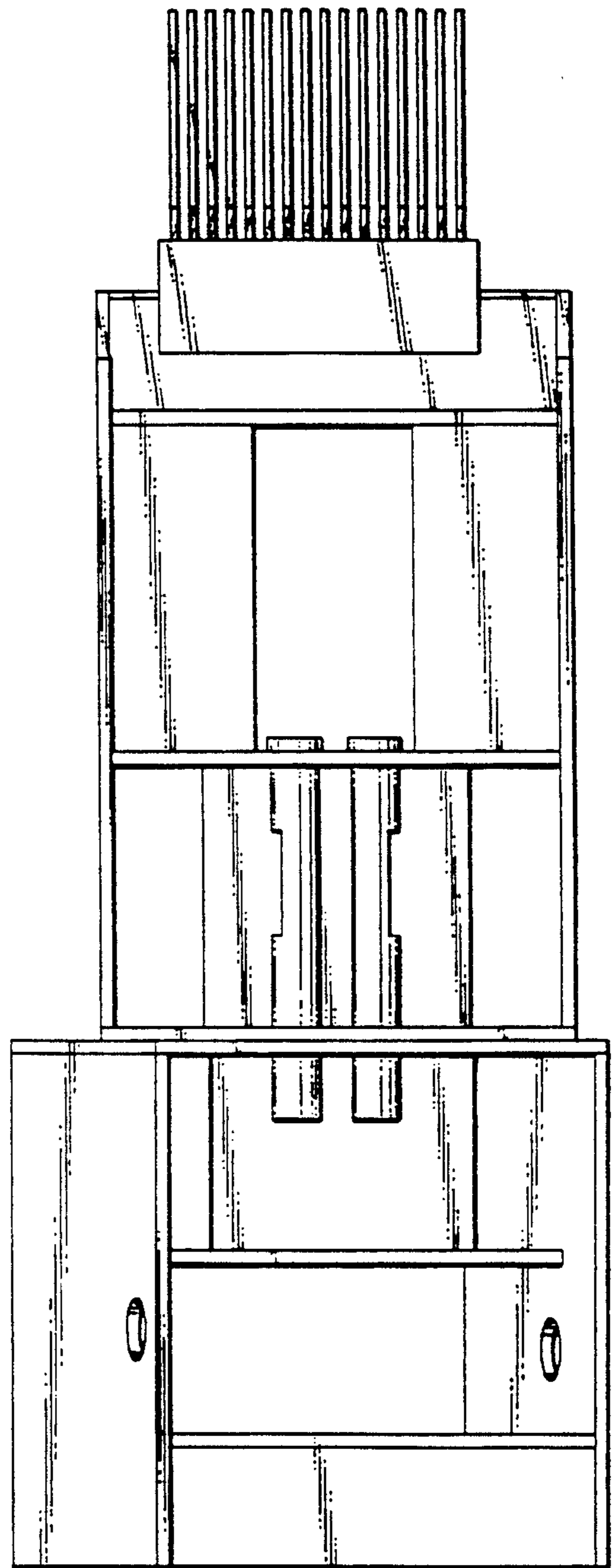

FIGURE 8