



US00D341312S

United States Patent [19]

Hansen

[11] Patent Number: Des. 341,312

[45] Date of Patent: ** Nov. 16, 1993

[54] BRACKET FOR HOLDING A STALK OF TOBACCO DURING DRYING

[76] Inventor: Elmer K. Hansen, Box 70244, Pahrump, Nev. 89041

[**] Term: 14 Years

[21] Appl. No.: 833,394

[22] Filed: Feb. 10, 1992

[52] U.S. Cl. D8/373

[58] Field of Search D8/349, 373, 354, 380, D8/366; 248/224.1; 56/27

3,178,141 4/1965 Bloom .
3,350,830 11/1967 Smith, Jr. et al. D8/373 X
4,134,499 1/1979 Joswig .
4,763,797 8/1988 Egan .

Primary Examiner—Wallace R. Burke
Assistant Examiner—H. Baynham
Attorney, Agent, or Firm—Brian J. Laurenzo; Kent A. Herink

[57] CLAIM

The ornamental design for a bracket for holding a stalk of tobacco during drying.

DESCRIPTION

FIG. 1 is a front bottom perspective view of a bracket for holding a stalk of tobacco during drying showing my new design illustrated with a portion of a support member shown in phantom;
FIG. 2 is a bottom plan view thereof;
FIG. 3 is a top plan view thereof;
FIG. 4 is a left side elevational view thereof;
FIG. 5 is a right side elevational view thereof;
FIG. 6 is a front elevational view thereof; and,
FIG. 7 is a rear elevational view thereof.

[56] References Cited

U.S. PATENT DOCUMENTS

D. 205,793	9/1966	Holmes	D8/354
D. 300,972	5/1989	Streno	D8/380 X
D. 312,039	11/1990	Smith	D8/373
D. 318,010	7/1991	Clinkscales	D8/373
555,085	2/1896	Frantz	.	
765,633	7/1904	Pope	.	
978,945	12/1910	Shafer	.	
1,309,125	7/1919	Ford	.	
2,550,956	5/1951	Biery	.	

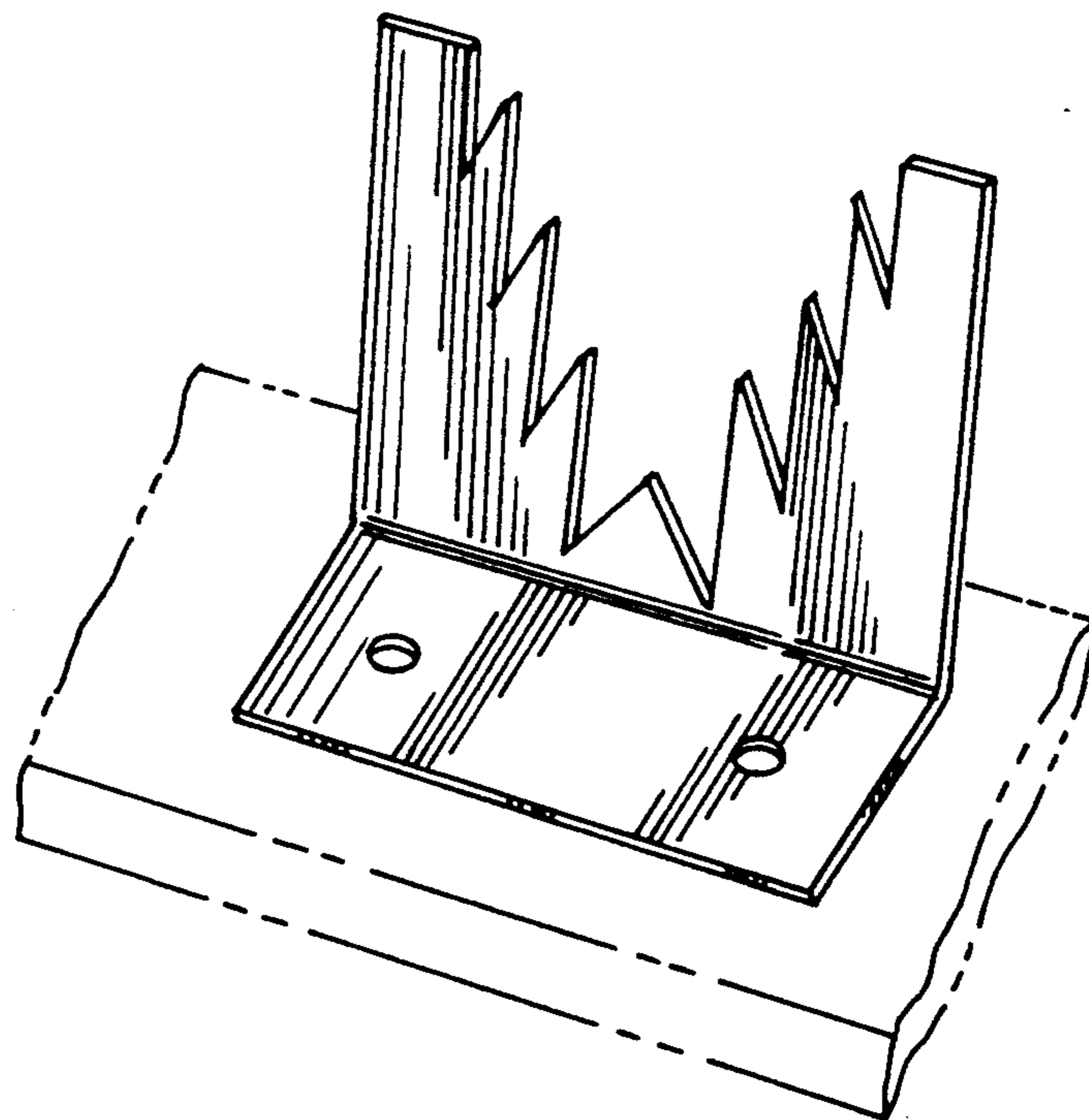

FIG. 1

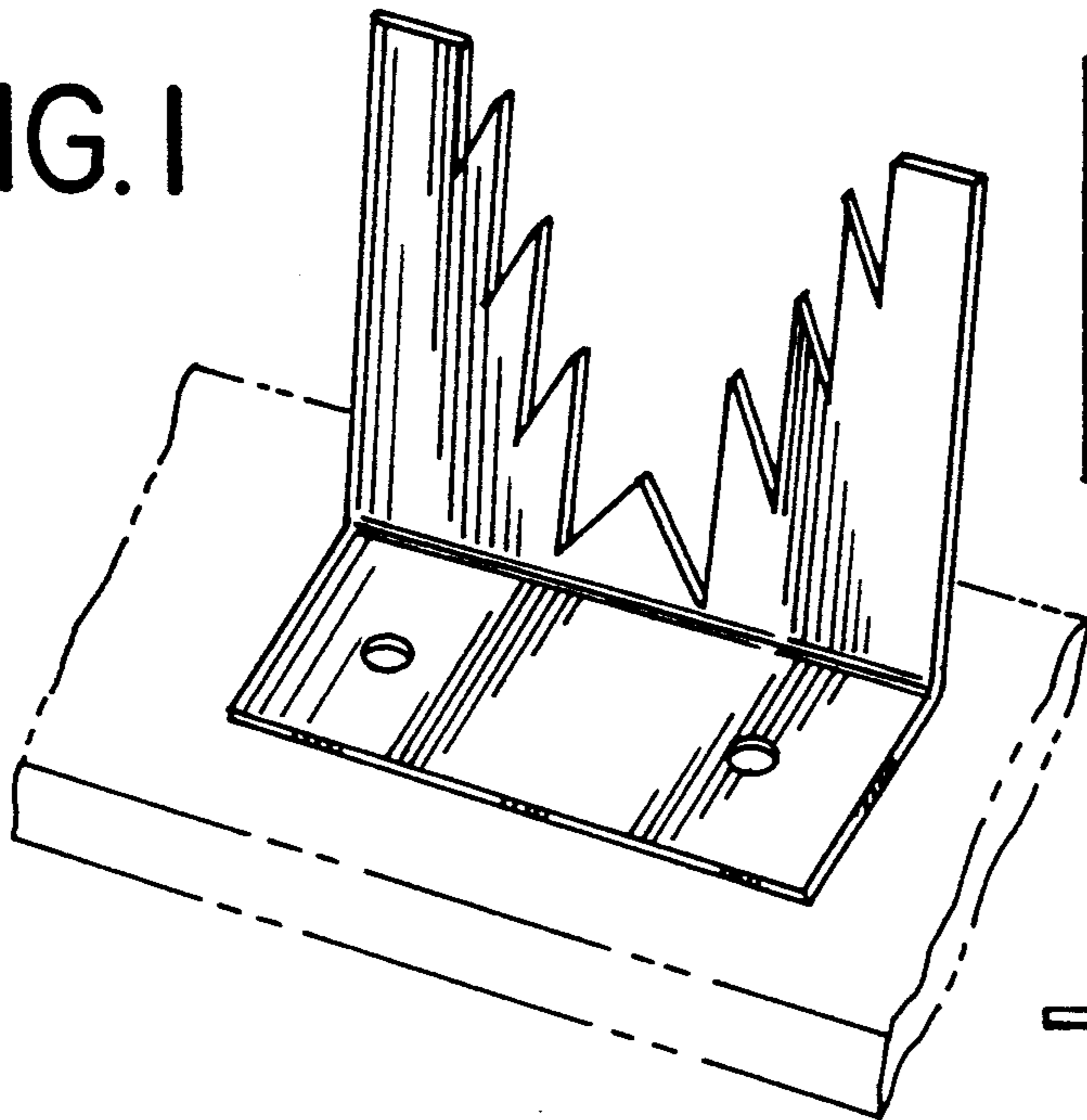

FIG. 3

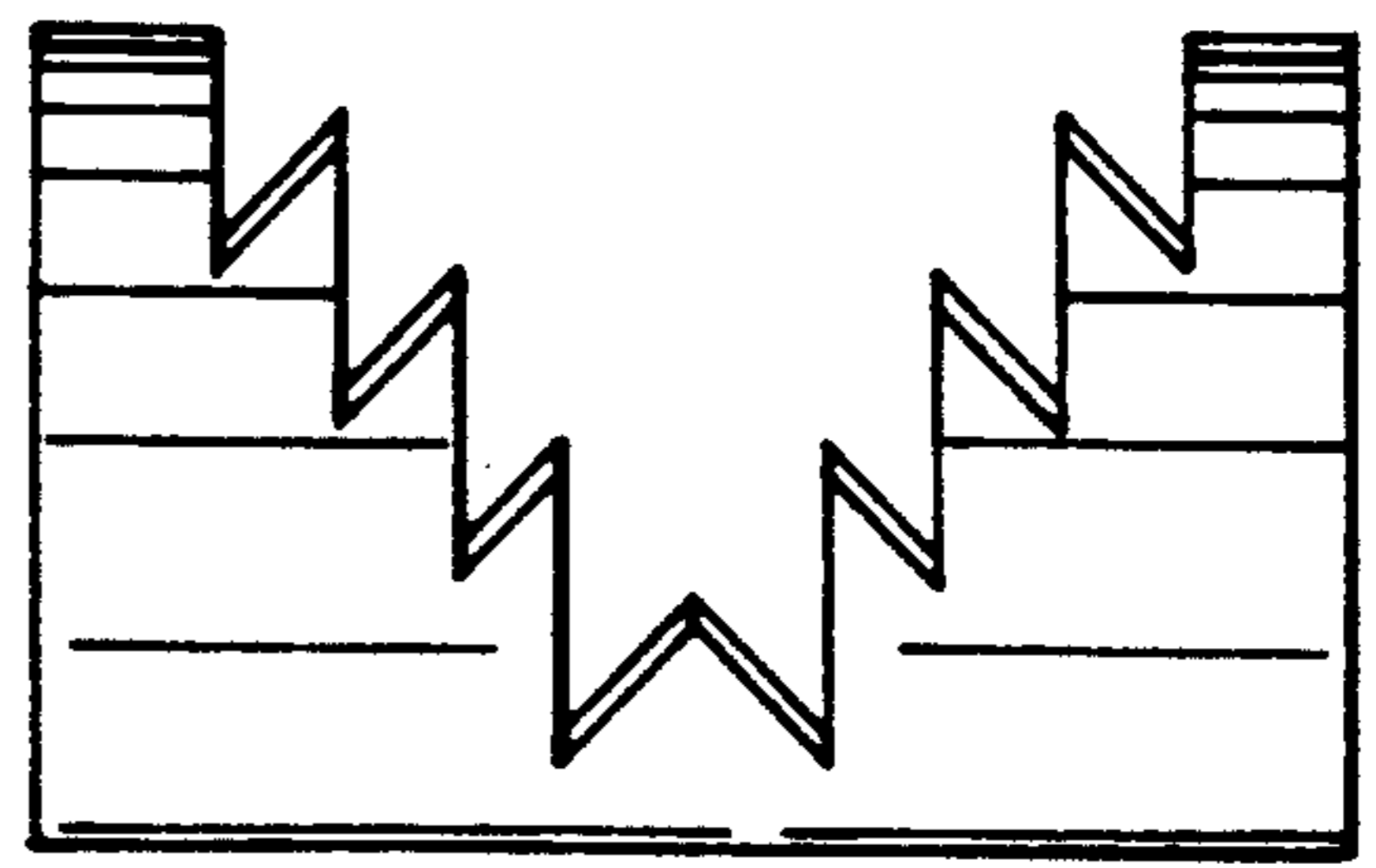

FIG. 5

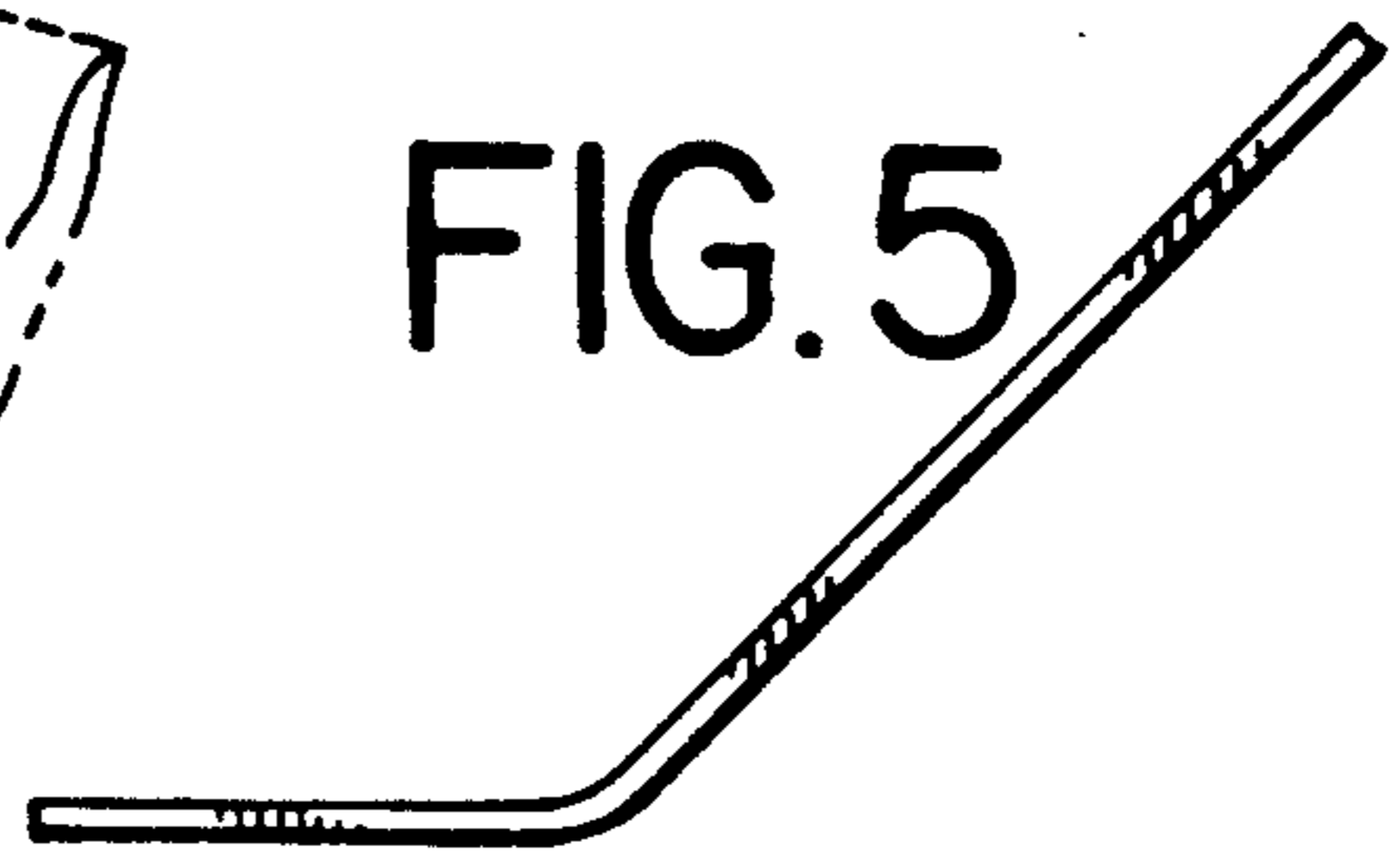

FIG. 4

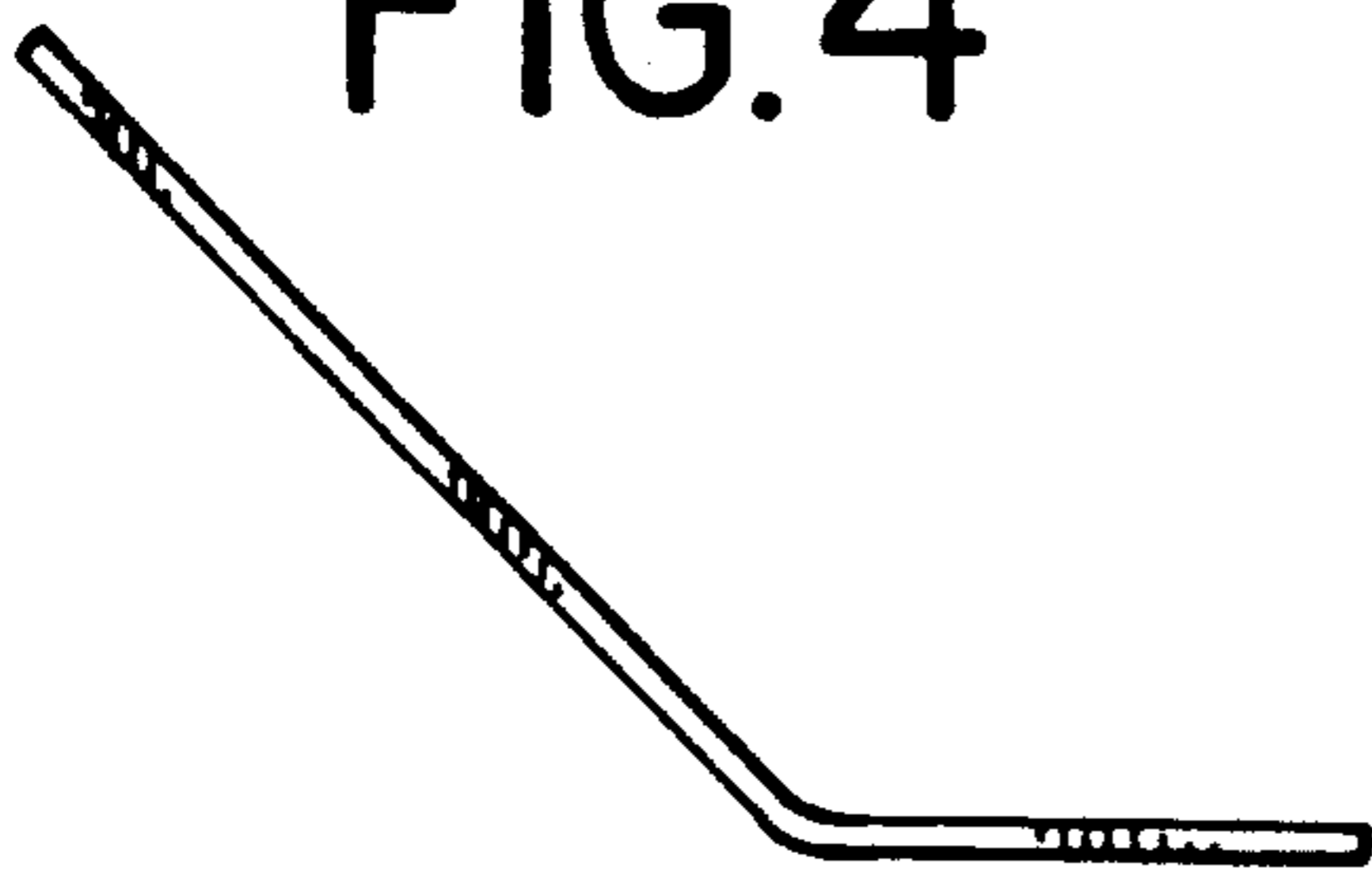

FIG. 2

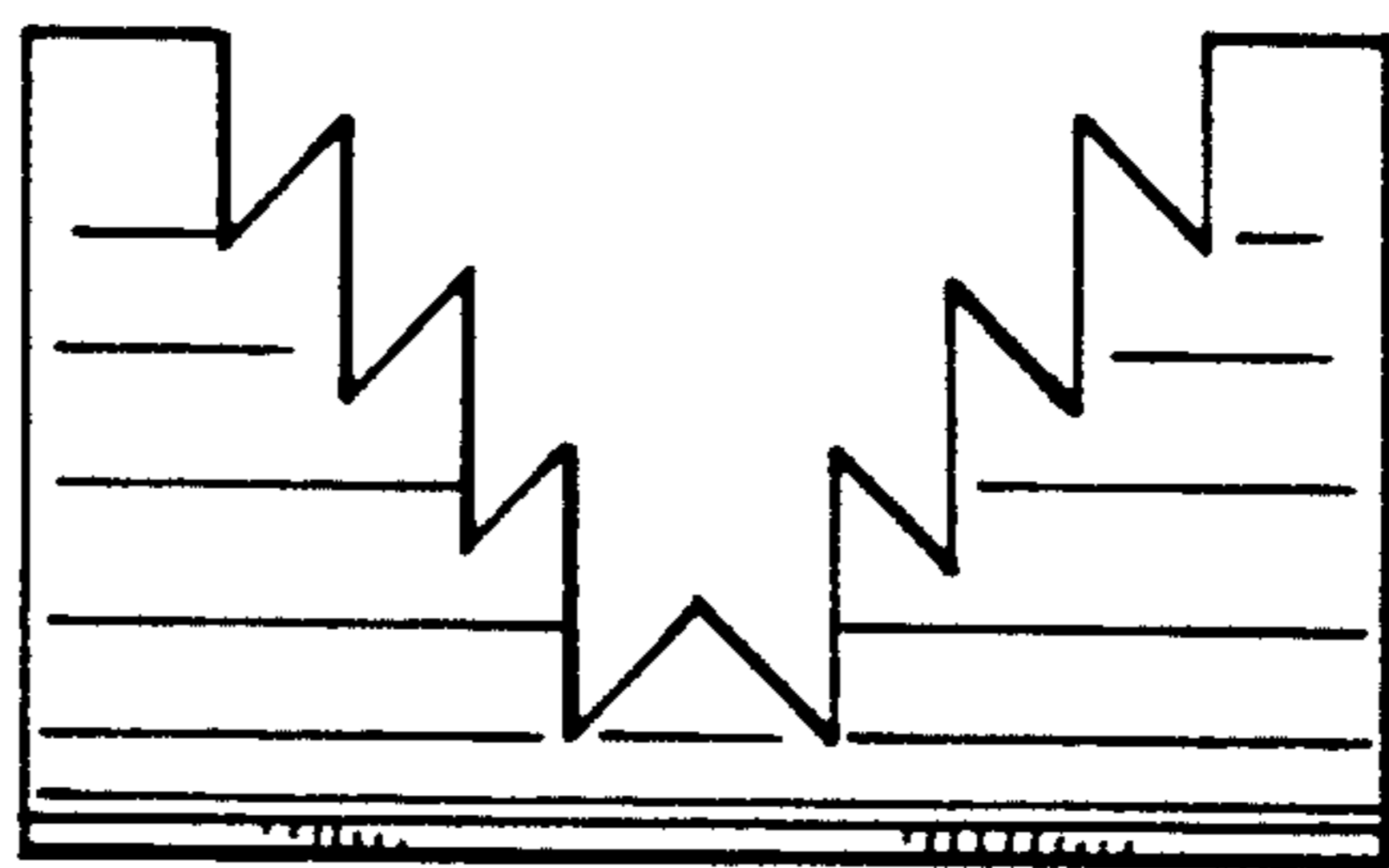

FIG. 6

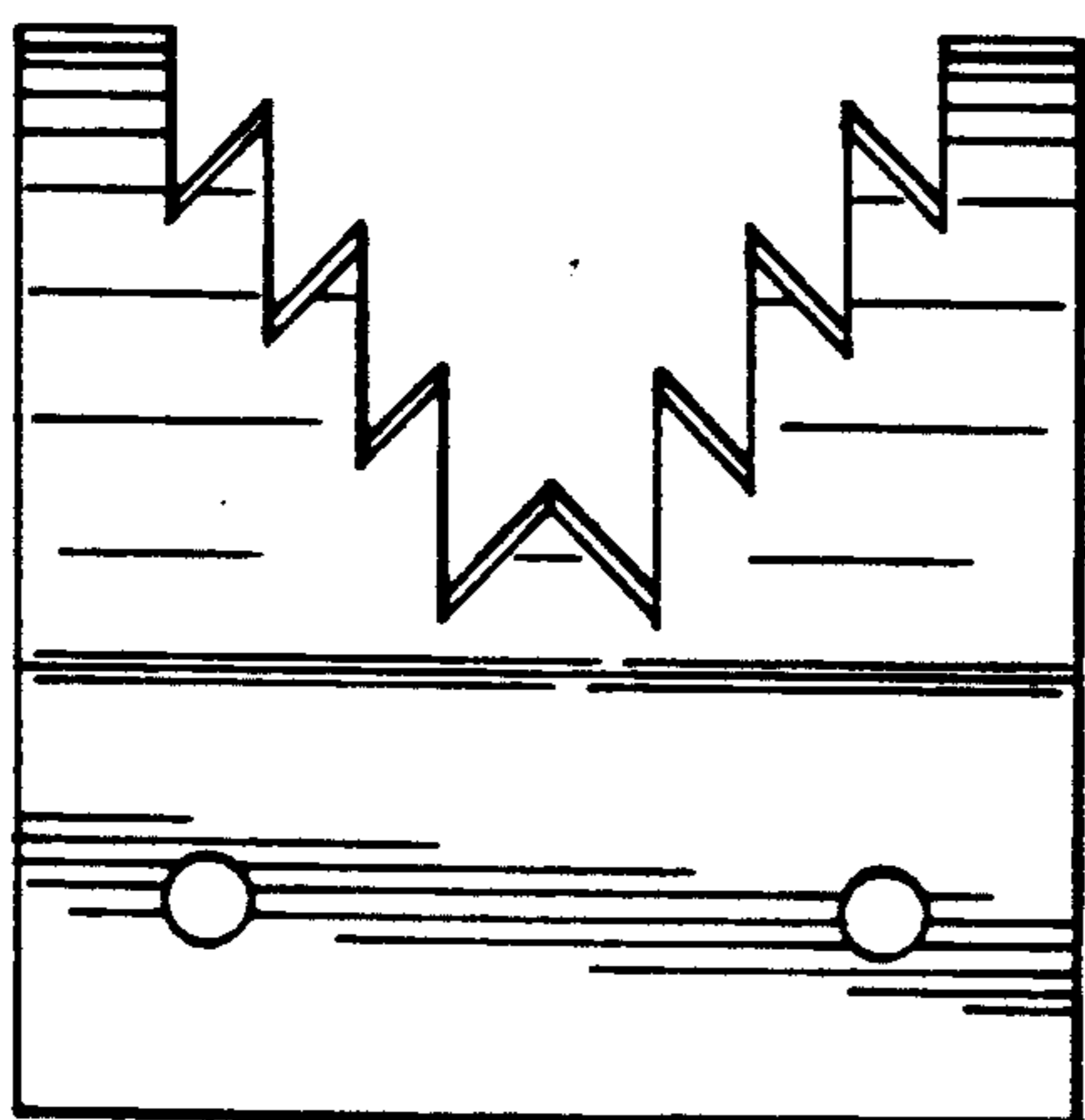

FIG. 7

