



US00D341260S

United States Patent [19]

[11] Patent Number: **Des. 341,260**

Fahnstrom et al.

[45] Date of Patent: **** Nov. 16, 1993**

[54] CHAIR

[75] Inventors: **Dale Fahnstrom**, Chicago, Ill.;
Michael McCoy, Bloomfield Hills,
Mich.; **Carl G. Magnusson**, New
York City, N.Y.

[73] Assignee: **Westinghouse Electric Corp.**,
Pittsburgh, Pa.

[*] Notice: The portion of the term of this patent
subsequent to Oct. 5, 2007 has been
disclaimed.

[**] Term: **14 Years**

[21] Appl. No.: **463,807**

[22] Filed: **Jan. 11, 1990**

[52] U.S. Cl. **D6/366**

[58] Field of Search **D6/366, 364, 365;**
297/DIG.1, DIG. 2, DIG. 3, 183, 184, 192,
194, 357, 411, 415, 417, 418, 421, 440, 468

[56] References Cited

U.S. PATENT DOCUMENTS

D. 266,803 11/1982 Fear **D6/366**
3,947,068 3/1976 Buhk .
4,754,364 6/1988 Speet et al. .

OTHER PUBLICATIONS

Interiors, Oct. 1977, p. 26, "KD General Office Series",
top center of page.

Interiors, May 1988, p. 6, "Delos Chair", left center of
page. D

The Madison Cat., Oct. 1985, Front cover, "The Madi-
son Chair," center of page.

Steelcase, pg. 9, "Operators Chair", center of page.

Steelcase, p. 20, "Swivel Side Chair," center of page.

Primary Examiner—Alan P. Douglas

Assistant Examiner—Martha Thompson

Attorney, Agent, or Firm—Carla J. Vrsansky

[57] CLAIM

The ornamental design for a chair, as shown and de-
scribed.

DESCRIPTION

FIG. 1 is a front perspective view of a chair showing
our new design;

FIG. 2 is a front elevational view thereof;

FIG. 3 is a right side elevational view thereof;

FIG. 4 is a rear elevational view thereof;

FIG. 5 is a left side elevational view thereof;

FIG. 6 is a top plan view thereof; and,

FIG. 7 is a bottom plan view thereof.

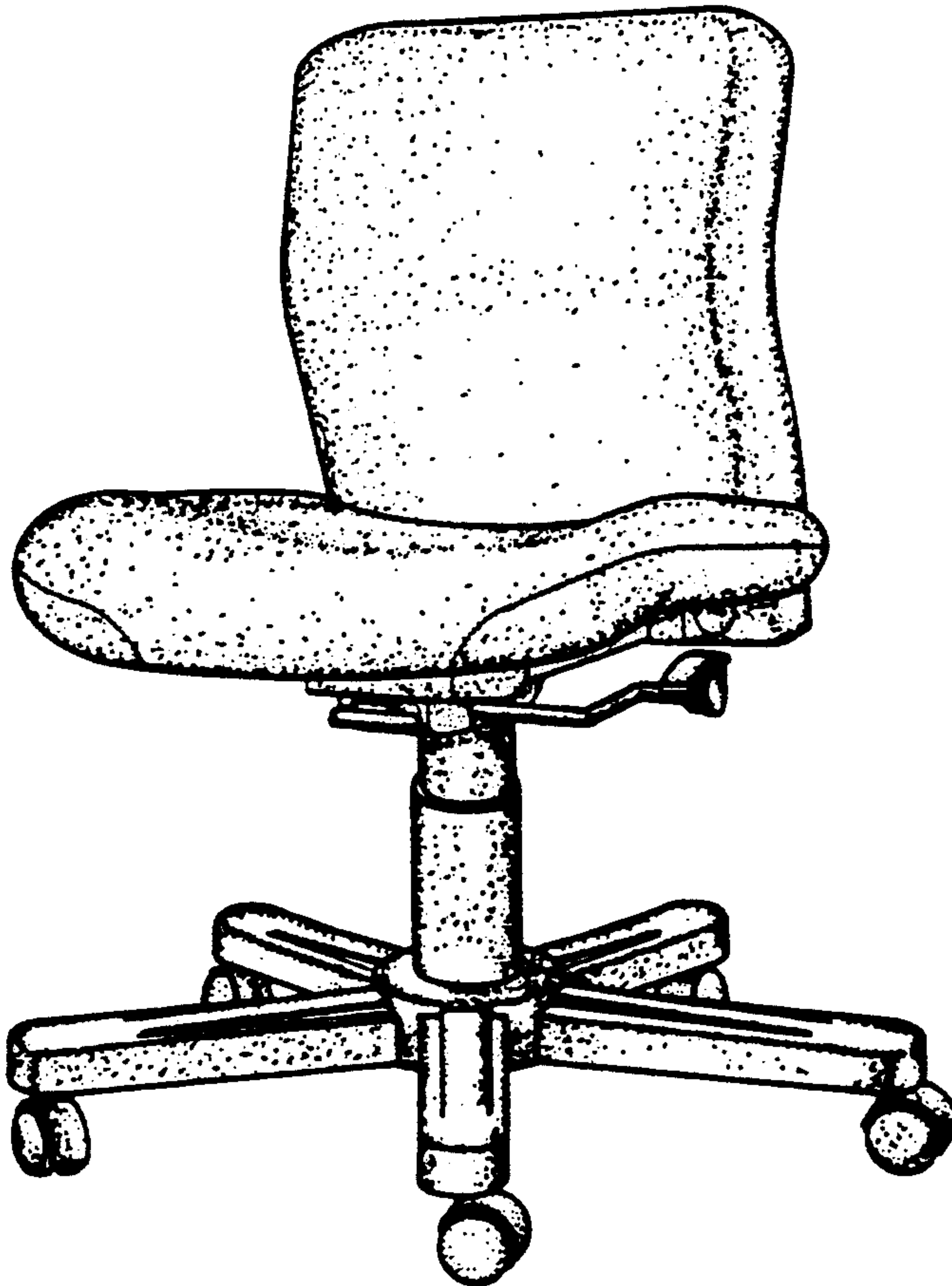

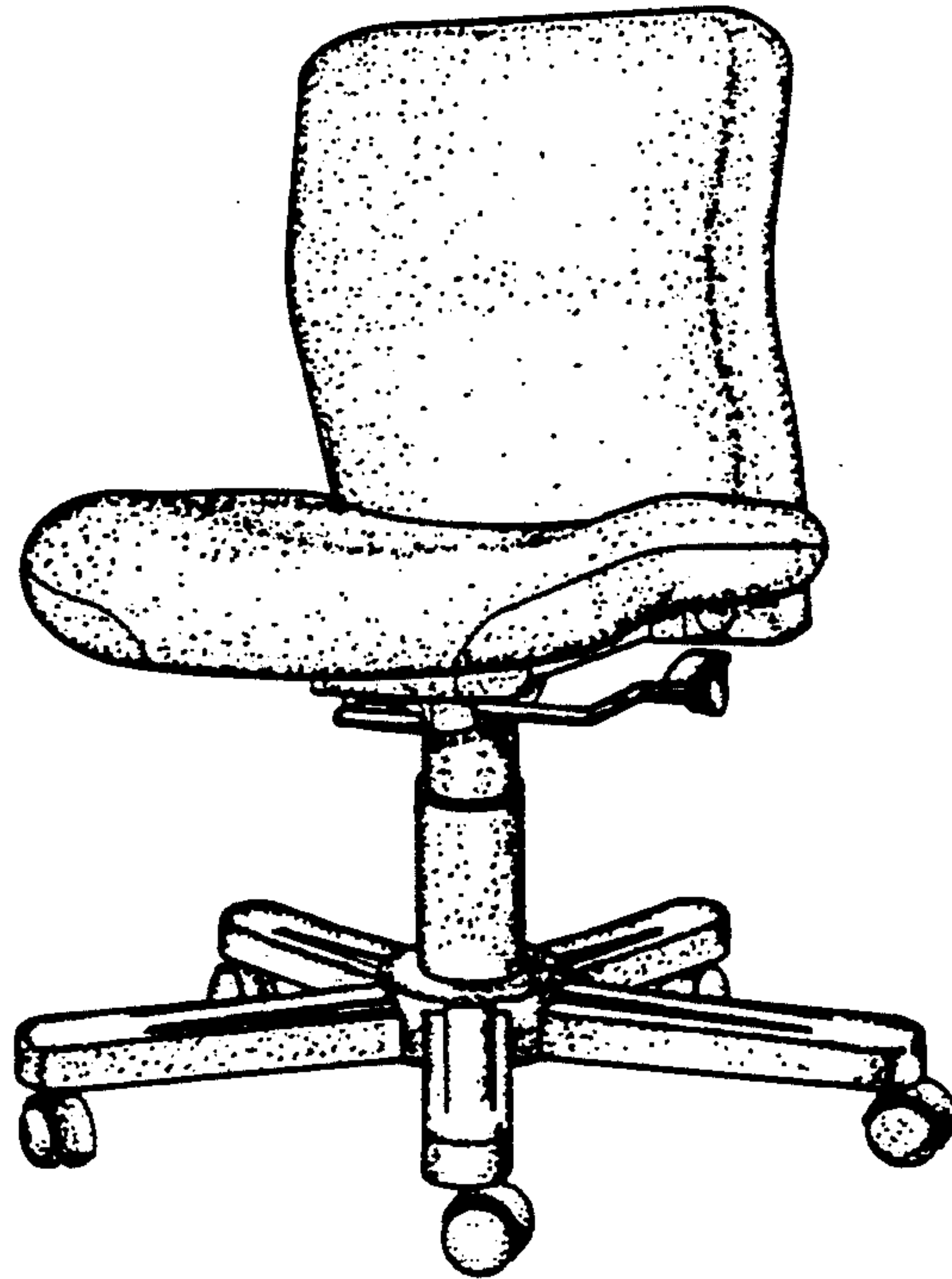

FIG. 1

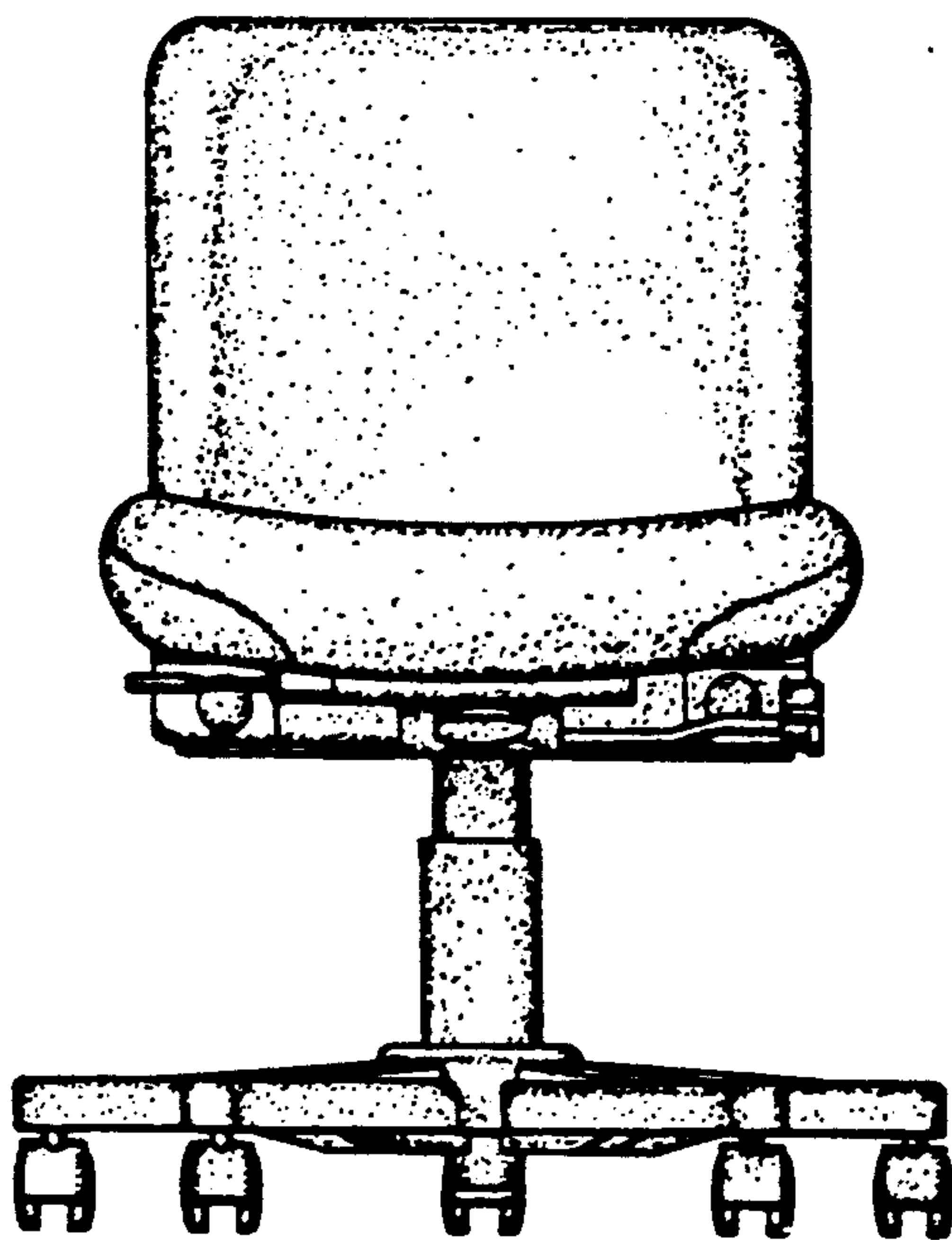

FIG. 2

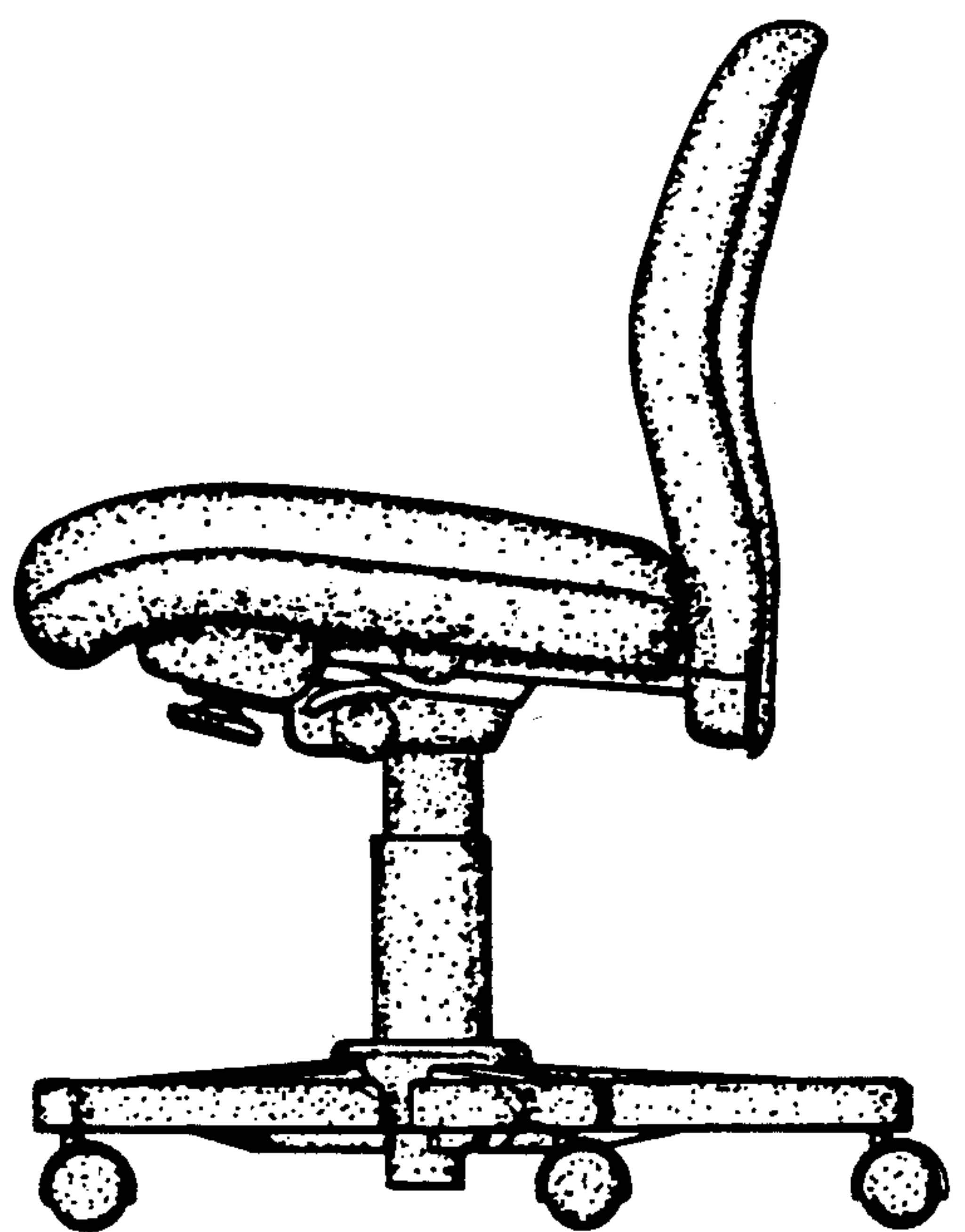

FIG. 3

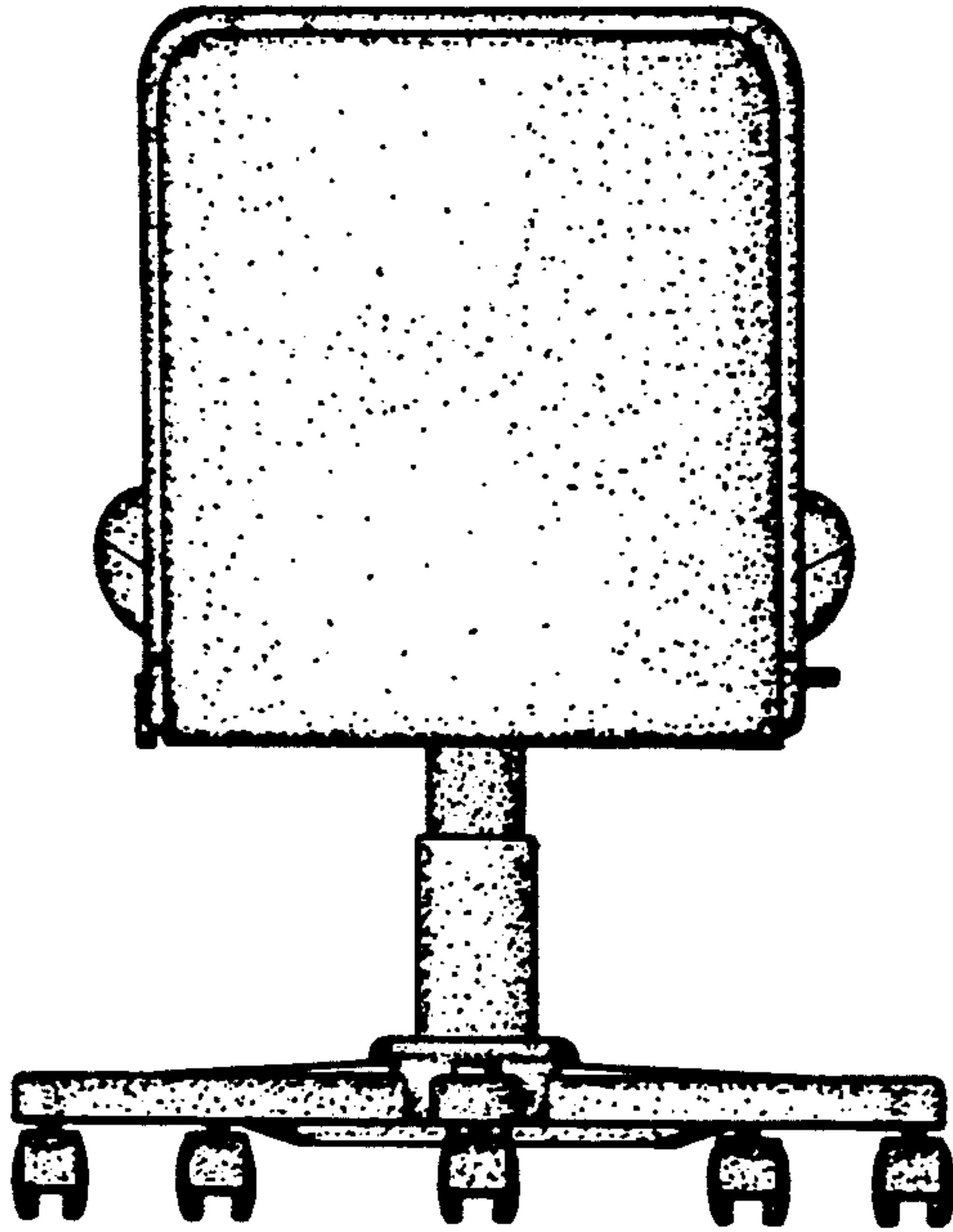

FIG. 4

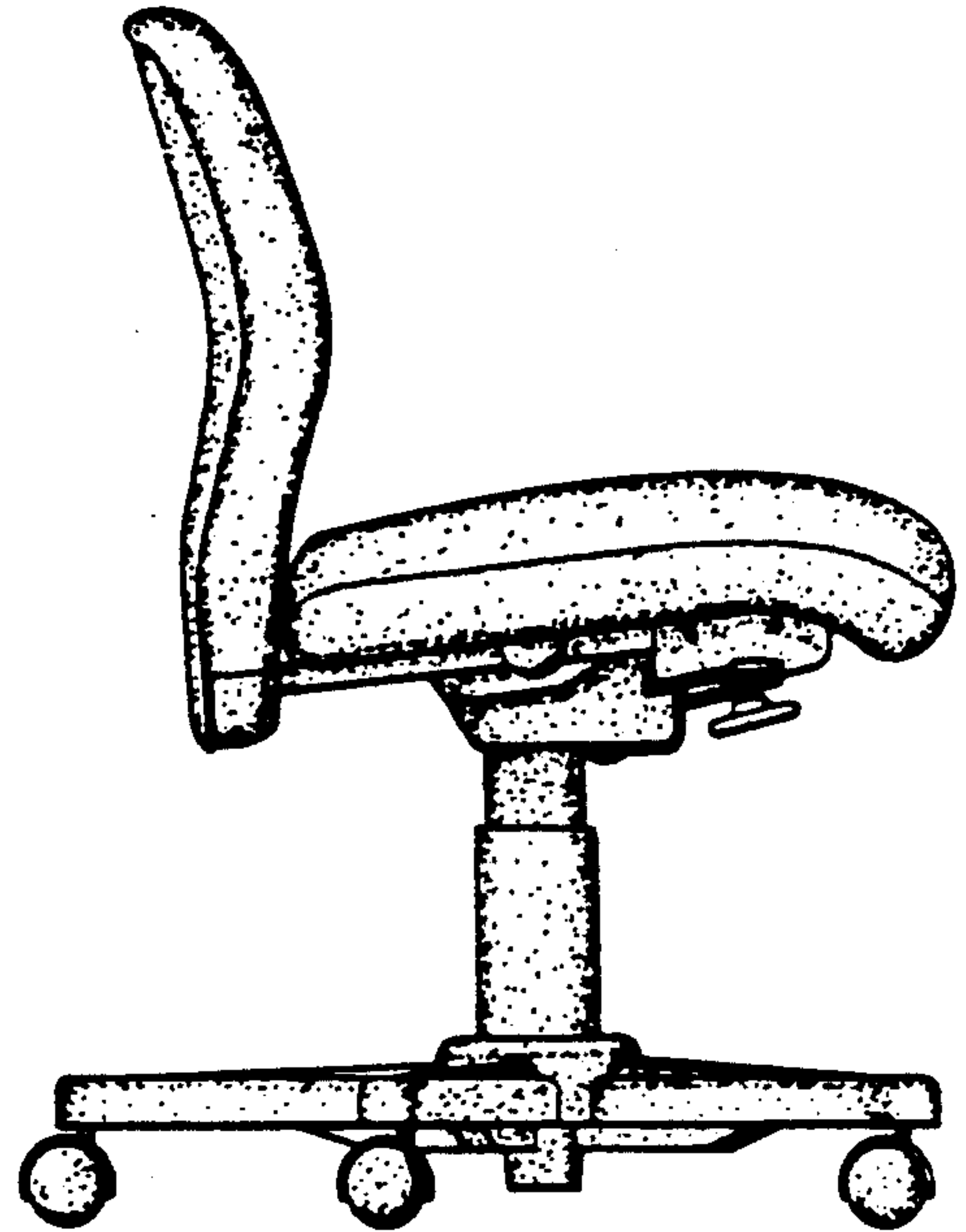

FIG. 5

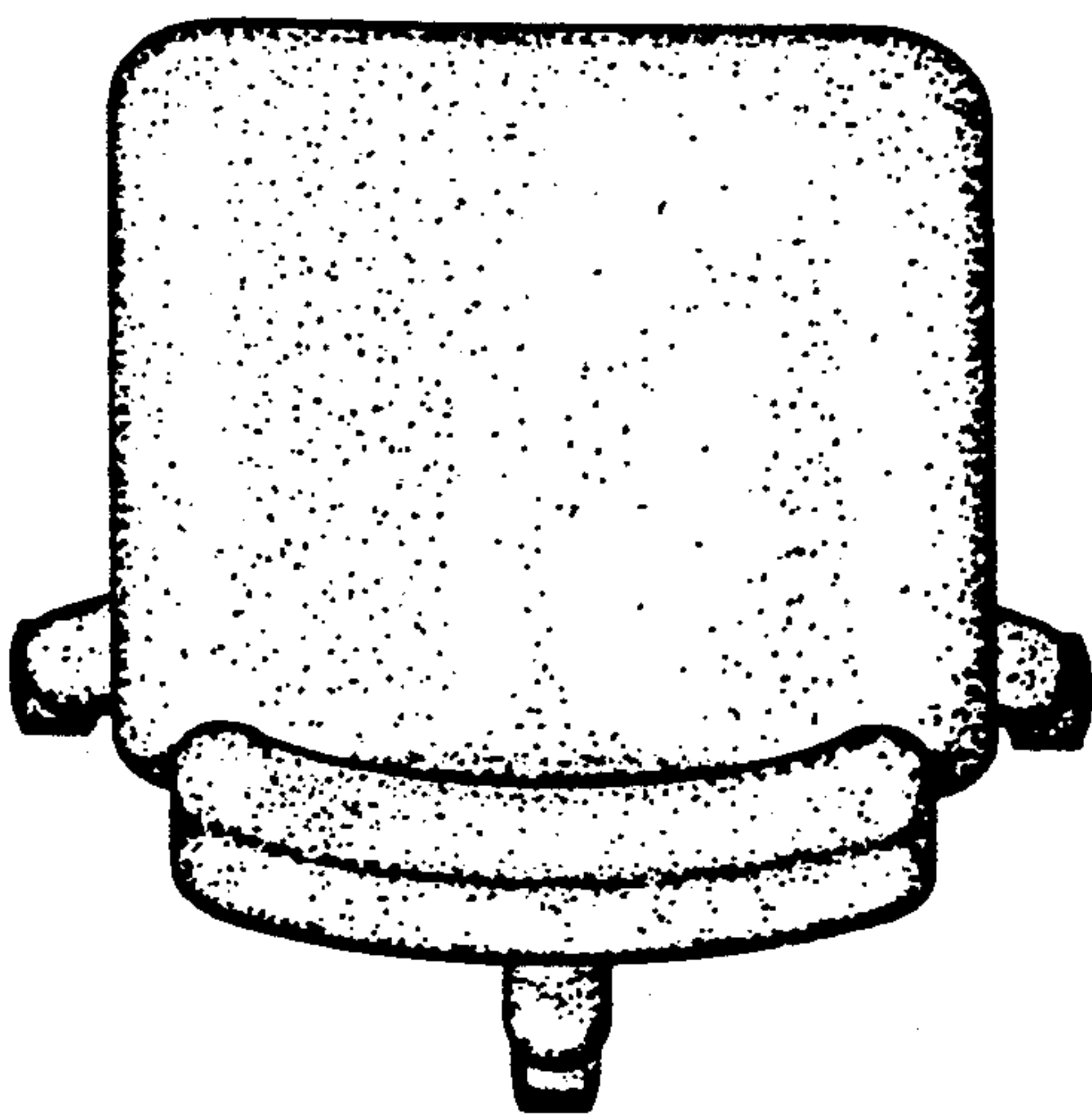

FIG. 6

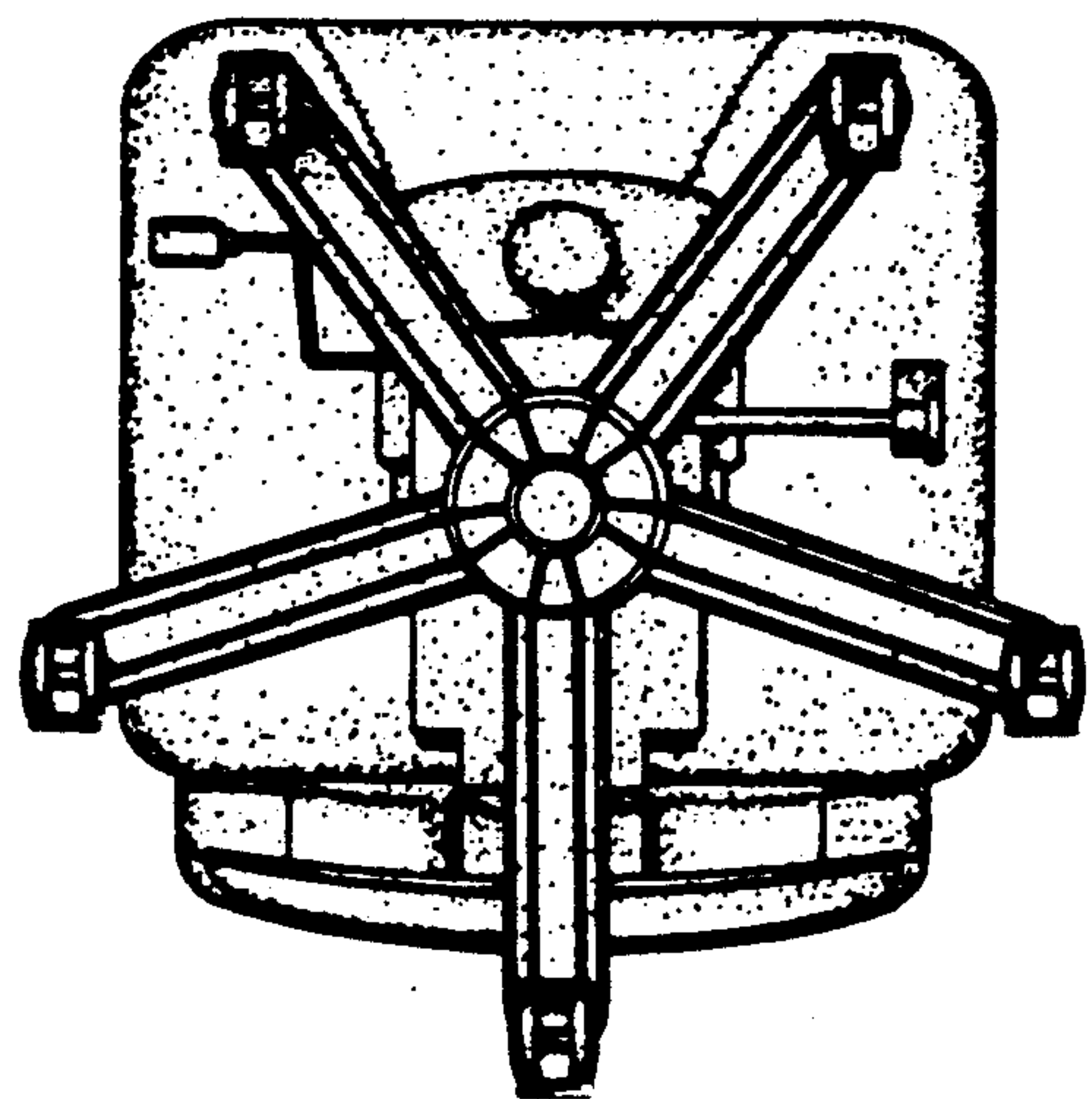

FIG. 7