



US00D341048S

# United States Patent [19]

[11] Patent Number: **Des. 341,048**

**Murro**

[45] Date of Patent: **\*\* Nov. 9, 1993**

[54] **BATHROOM SUPPLIES STORAGE UNIT**

D. 323,089	1/1992	Kuerbel	.....	D6/525
D. 326,974	6/1992	Grassie	.....	D6/524
D. 329,561	9/1992	Nyorkor	.....	D6/524 X
3,232,478	2/1966	Thomasma et al.	.....	221/33
4,754,883	7/1988	Grzywa	.....	211/71

[76] Inventor: **Antonio S. Murro**, Crystal Hills,  
18308 26th Dr. SE., Bothell, Wash.  
98012

[\*\*] Term: **14 Years**

*Primary Examiner*—Brian N. Vinson  
*Attorney, Agent, or Firm*—Leon Gilden

[21] Appl. No.: **889,749**

[57] **CLAIM**

[22] Filed: **May 29, 1992**

The ornamental design for a bathroom supplier storage unit, as shown and described.

[52] U.S. Cl. .... **D6/525**

[58] Field of Search ..... D6/524-525,  
D6/526, 527, 532; D23/223, 271, 304;  
206/77.1; 211/10, 13, 49.1, 71, 86-88; 221/33,  
45, 282-286; 222/173, 181

**DESCRIPTION**

[56] **References Cited**

**U.S. PATENT DOCUMENTS**

D. 301,291	5/1989	Plant	.....	D6/527
D. 305,589	1/1990	Timmons	.....	D6/524

FIG. 1 is a front elevational view of the bathroom supplies storage unit showing my new design; FIG. 2 is a rear elevational view thereof; FIG. 3 is a left side elevational view thereof; FIG. 4 is a right side elevational view thereof; FIG. 5 is a top plan view thereof; FIG. 6 is a bottom plan view thereof; and, FIG. 7 is a perspective view thereof.

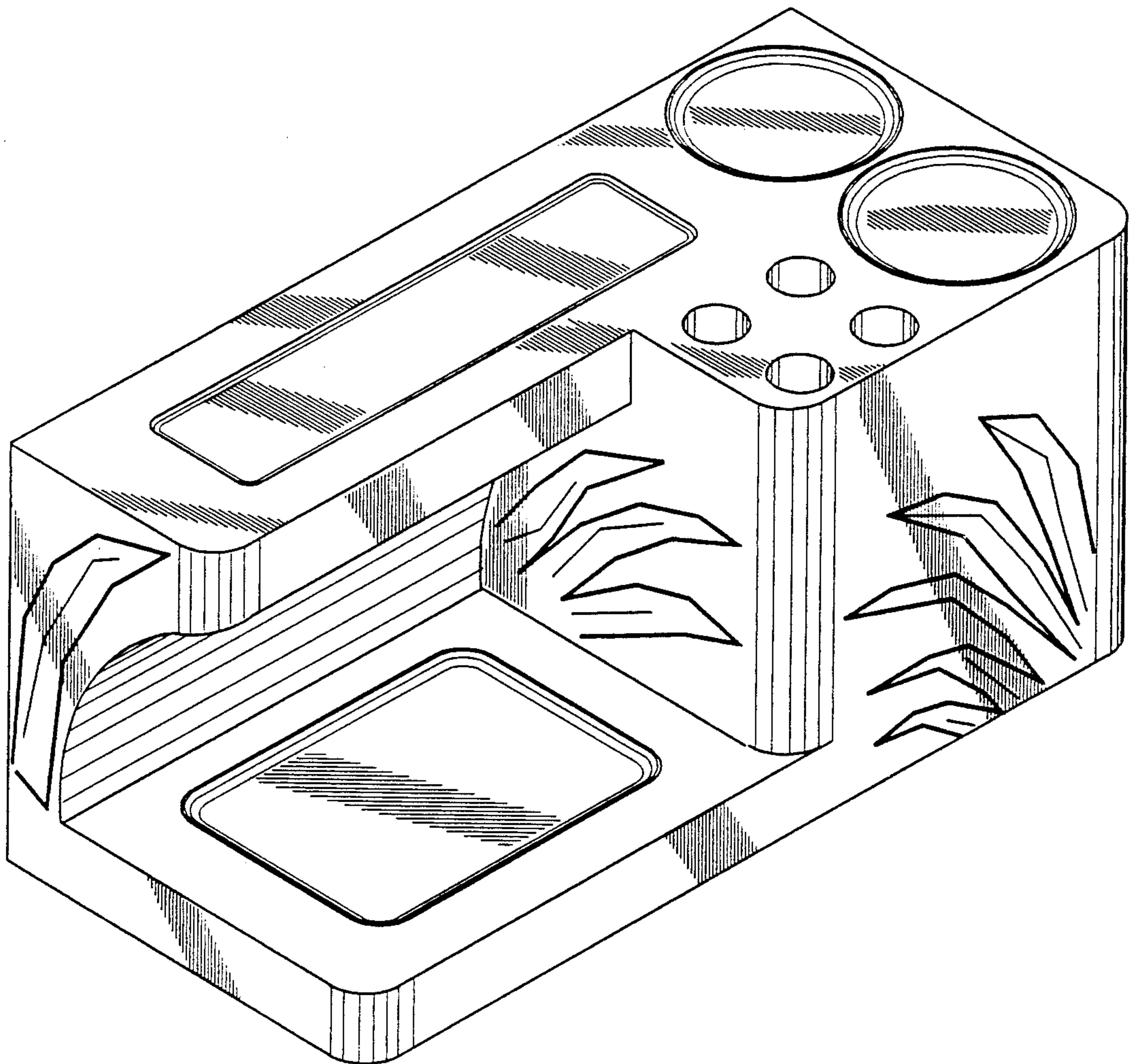

FIG. 1

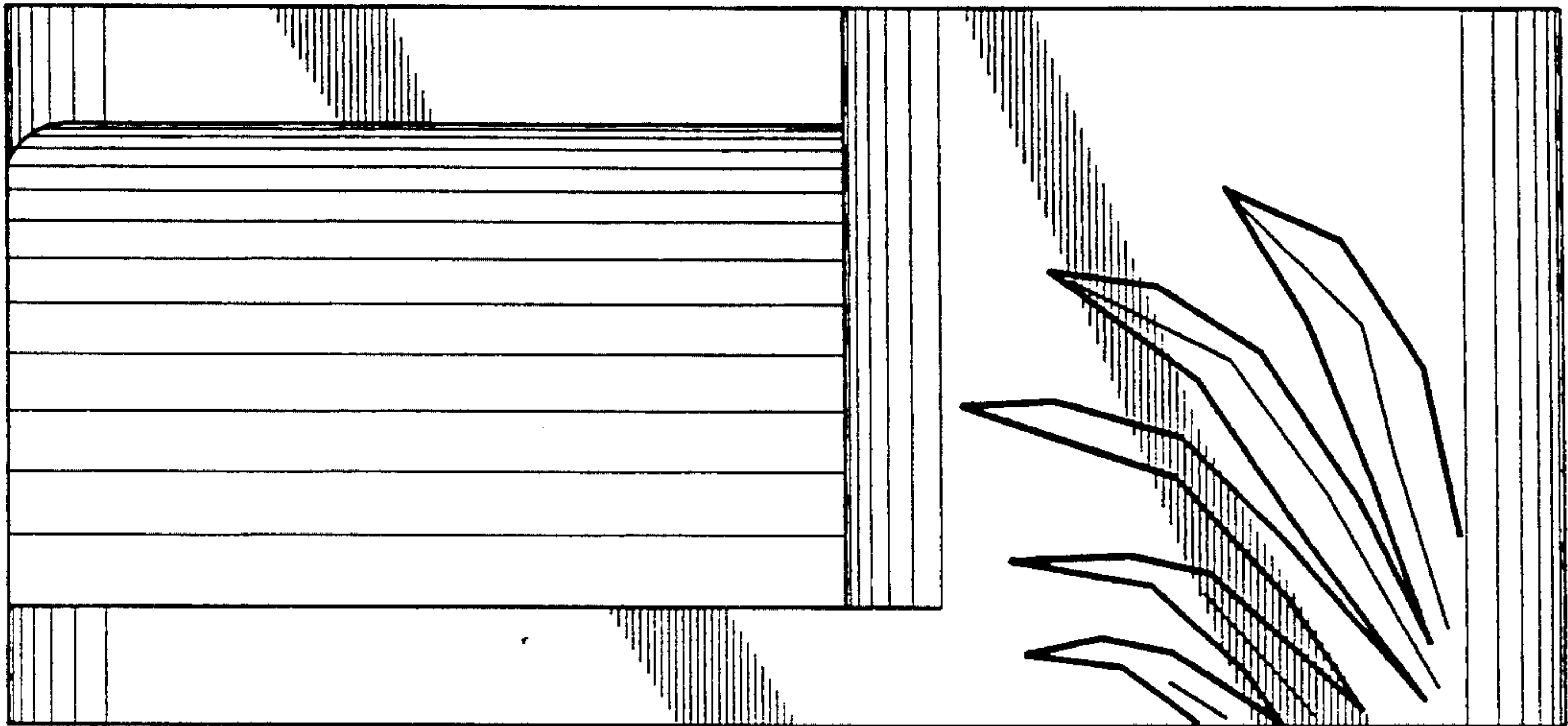
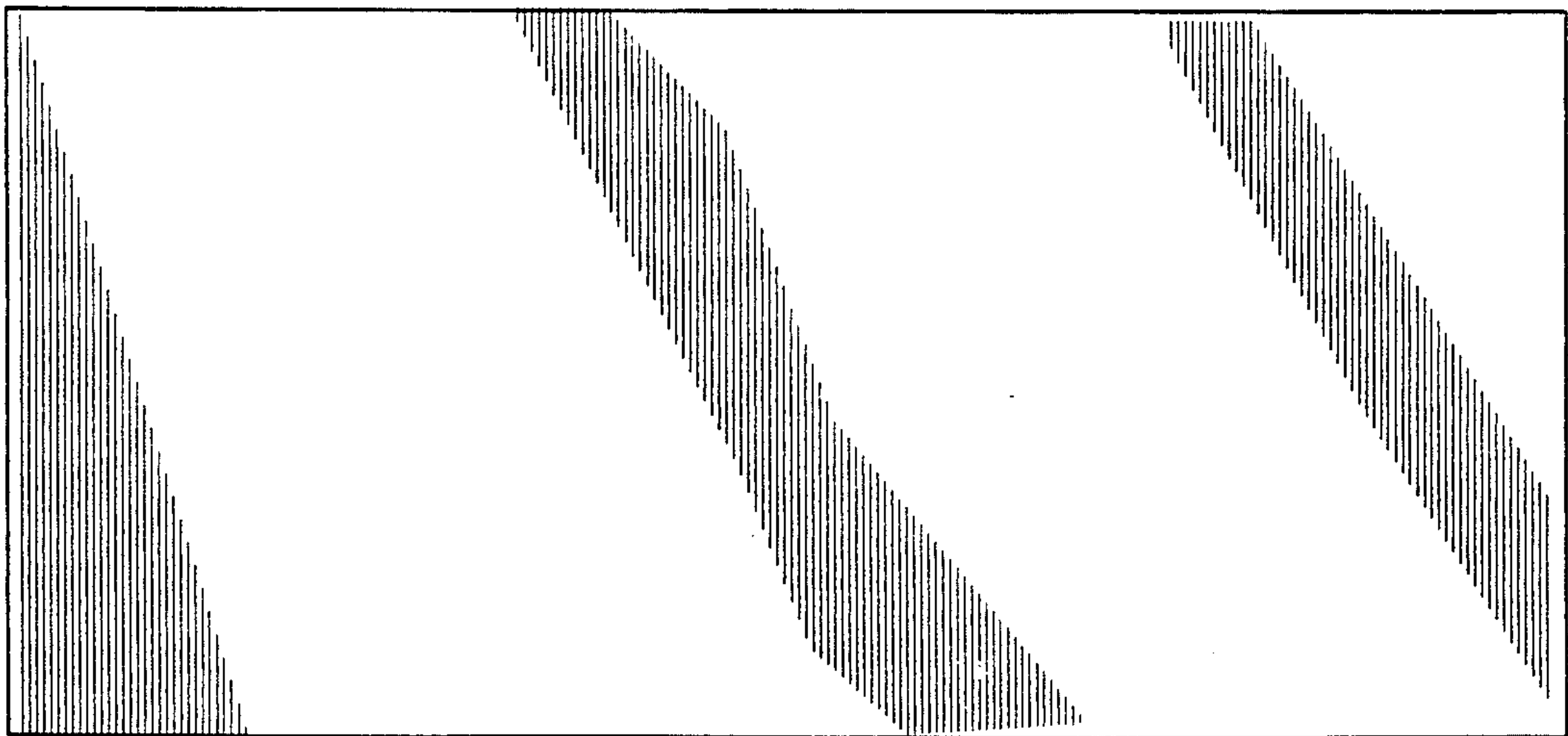

FIG. 2



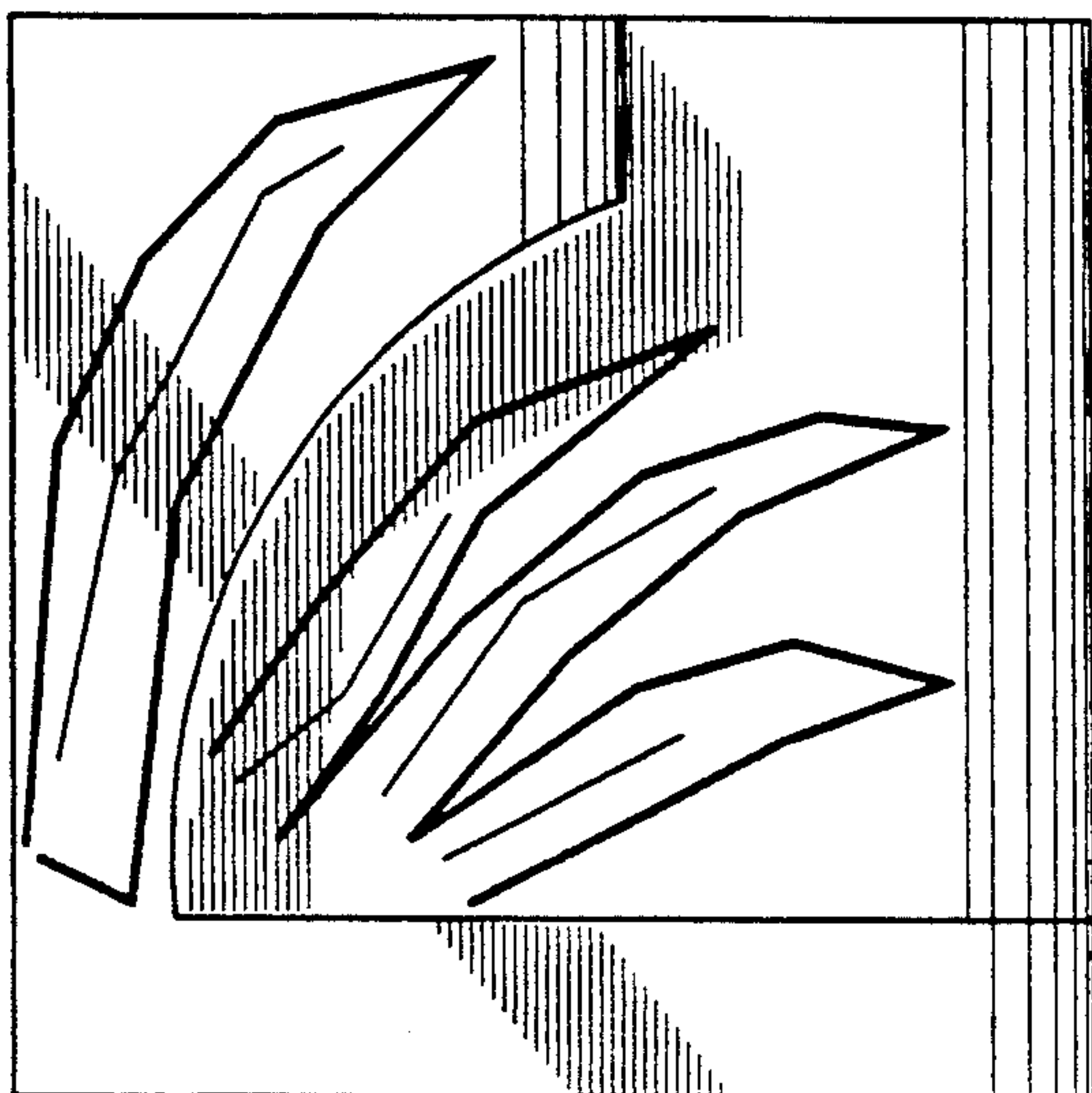

FIG. 3

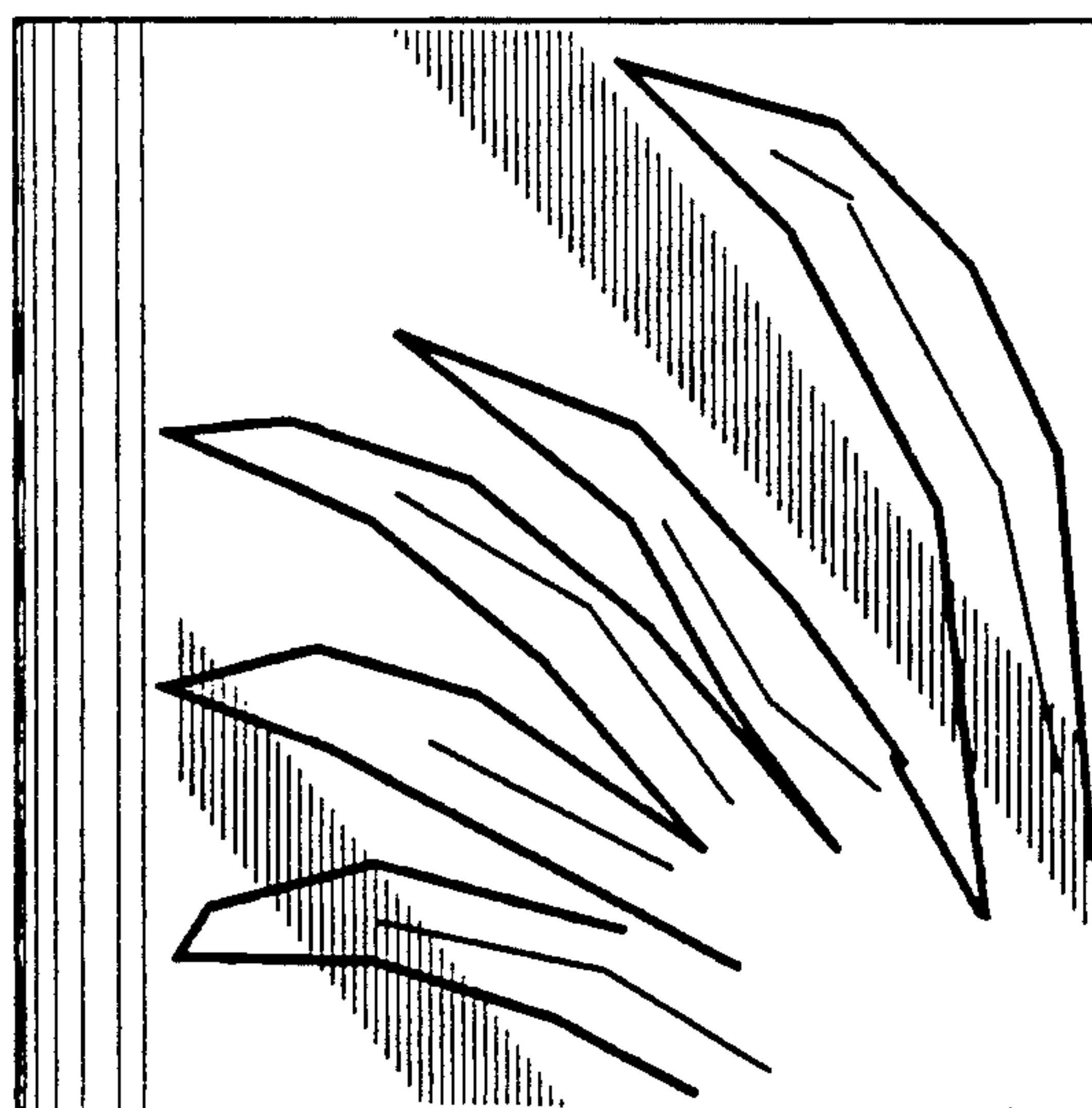

FIG. 4



FIG. 5

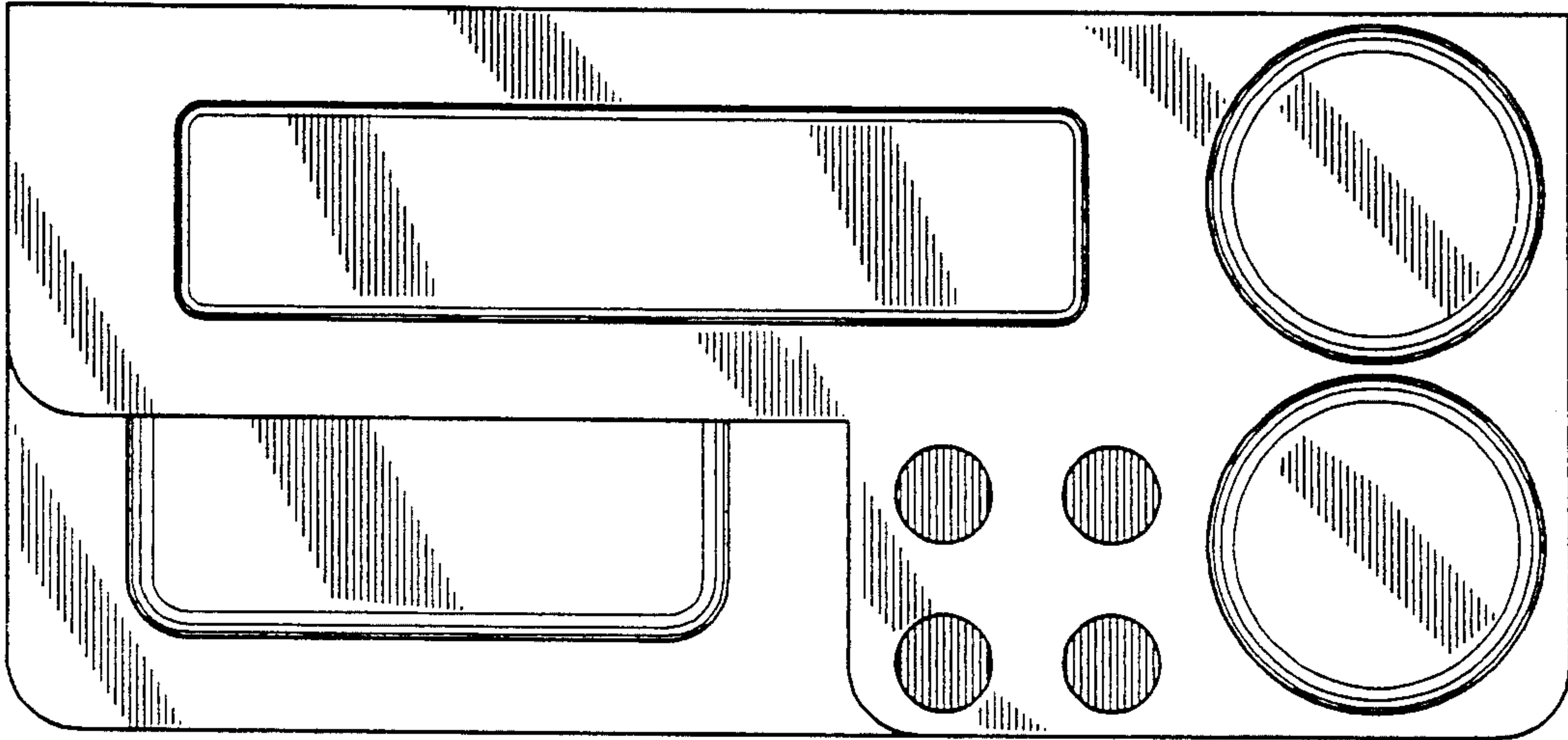

FIG. 6

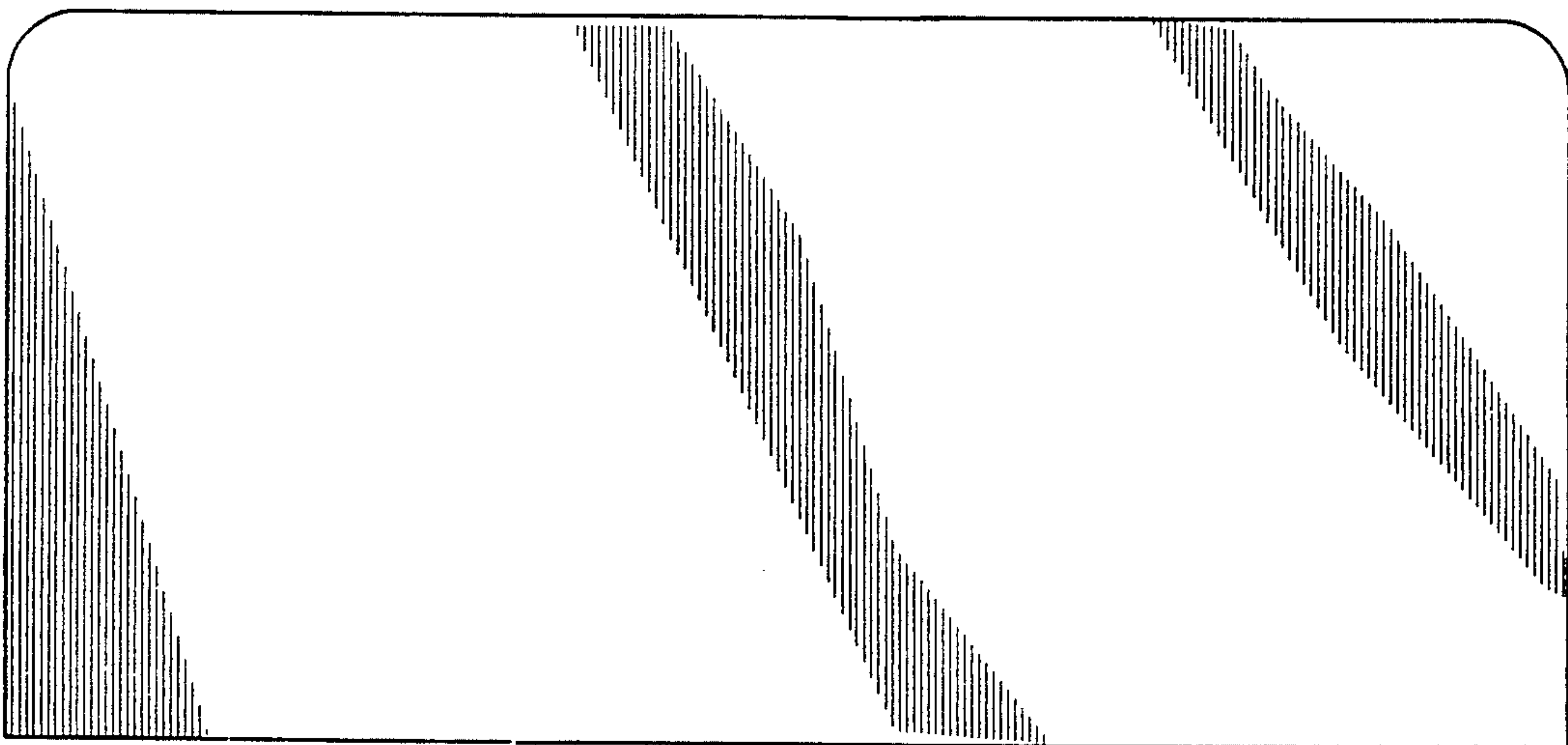

FIG. 7

