



US00D341035S

# United States Patent [19]

[11] Patent Number: **Des. 341,035**

**Schwartz**

[45] Date of Patent: **\*\* Nov. 9, 1993**

[54] **ARM CHAIR**

[75] Inventor: **Larry A. Schwartz, Franklin, N.J.**

[73] Assignee: **Omni Products International, Inc.,  
Richmond, Va.**

[\*\*] Term: **14 Years**

[21] Appl. No.: **761,017**

[22] Filed: **Sep. 13, 1991**

[52] U.S. Cl. .... **D6/370; D6/373;  
D6/379**

[58] Field of Search ..... **D6/334, 370, 371, 372,  
D6/373, 374, 375, 376, 379, 380, 500, 501, 502;  
297/419, 445, 446, 457**

[56] **References Cited**

**U.S. PATENT DOCUMENTS**

- D. 90,911 10/1933 Goodman .
- D. 94,089 9/1934 Lucas .
- D. 99,562 5/1936 Johnson .
- D. 113,144 1/1939 Meitner .
- D. 113,406 2/1939 Uber .
- D. 141,648 6/1945 Bannister .
- D. 144,719 5/1946 King et al. .
- D. 145,678 10/1946 Roth .
- D. 156,229 11/1949 Goldberg ..... D6/373
- D. 164,487 9/1951 Goldberg .
- D. 167,608 9/1952 Becker .
- D. 179,926 3/1957 Werner et al. .... D6/373
- D. 203,109 12/1965 Barecki et al. .
- D. 213,438 3/1969 Koch .
- D. 223,569 5/1972 Grosfellix .
- D. 237,671 11/1975 Grosfillex .
- D. 244,651 6/1977 Burke ..... D6/373
- D. 244,895 7/1977 Diehl ..... D6/373
- D. 249,760 10/1978 Gageby .
- D. 249,846 10/1978 Gageby ..... D6/373
- D. 252,904 9/1979 Springfield .
- D. 252,905 9/1979 Springfield .
- D. 253,678 12/1979 Gibilterra .
- D. 262,077 12/1981 Deconinck .
- D. 277,053 1/1985 Golden et al. .
- D. 277,241 1/1985 Massonnet .
- D. 277,917 3/1986 Slakman .
- D. 279,243 6/1985 Vanderminden .
- D. 279,947 8/1985 Ballarini .
- D. 280,474 9/1985 Vanderminden .
- D. 281,941 12/1985 Ambasz et al. .

- D. 288,994 3/1987 Winters .
- D. 289,238 4/1987 Arthur, Jr. .
- D. 289,349 4/1987 Vanderminden .
- D. 291,391 8/1987 Arthur, Jr. .
- D. 293,982 2/1988 Vogtherr .
- D. 294,436 3/1988 Colby .
- D. 296,848 7/1988 Colby .
- D. 298,787 12/1988 Greene .
- D. 300,587 4/1989 Uredat .
- D. 300,588 4/1989 White .
- D. 308,305 6/1990 Snodgrass .
- D. 308,306 6/1990 Dozsa-Farkas .
- D. 311,460 10/1990 Greene .
- D. 313,515 1/1991 Wood .
- D. 320,508 10/1991 Klawitter .
- D. 320,895 10/1991 Frinier .
- D. 323,249 1/1992 Schwartz ..... D6/370
- D. 325,837 5/1992 Schwartz ..... D6/370 X

**OTHER PUBLICATIONS**

Omni's Casual Furniture Catalog—Casual Furniture collection 1991: "Atlantis" chair.

*Primary Examiner*—Alan P. Douglas  
*Assistant Examiner*—Gary D. Watson  
*Attorney, Agent, or Firm*—Lerner, David, Littenberg, Krumholz & Mentlik

[57] **CLAIM**

The ornamental design for an arm chair, as shown and described.

**DESCRIPTION**

FIG. 1 is a front perspective view, looking slightly from above, of an arm chair in accordance with one embodiment showing my new design;  
 FIG. 2 is a front elevational view;  
 FIG. 3 is a top plan view;  
 FIG. 4 is a right side elevational view, the left side being a mirror image thereof;  
 FIG. 5 is a rear elevational view;  
 FIG. 6 is a bottom plan view;  
 FIG. 7 is a front perspective view, looking slightly from above, of an arm chair in accordance with another embodiment showing my new design;  
 FIG. 8 is a front elevational view;  
 FIG. 9 is a top plan view;

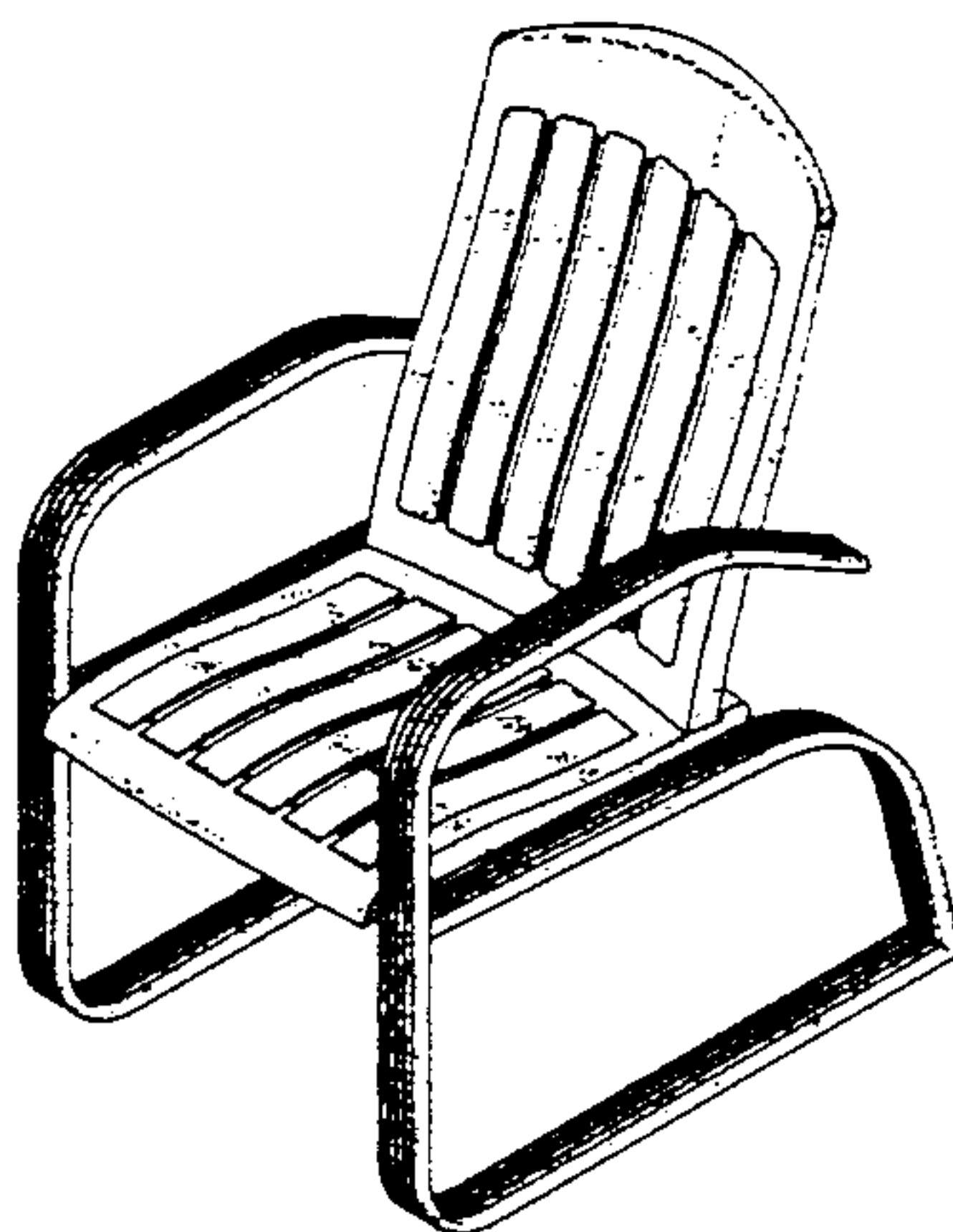

FIG. 10 is a right side elevational view, the left side being a mirror image thereof;

FIG. 11 is a rear elevational view;

FIG. 12 is a bottom plan view;

FIG. 13 is a front perspective view, looking slightly

from above, of an arm chair in accordance with another embodiment showing my new design;

FIG. 14 is a front elevational view;

FIG. 15 is a top plan view;

FIG. 16 is a right side elevational view, the left side being a mirror image thereof;

FIG. 17 is a rear elevational view; and,

FIG. 18 is a bottom plan view.

FIG. 1

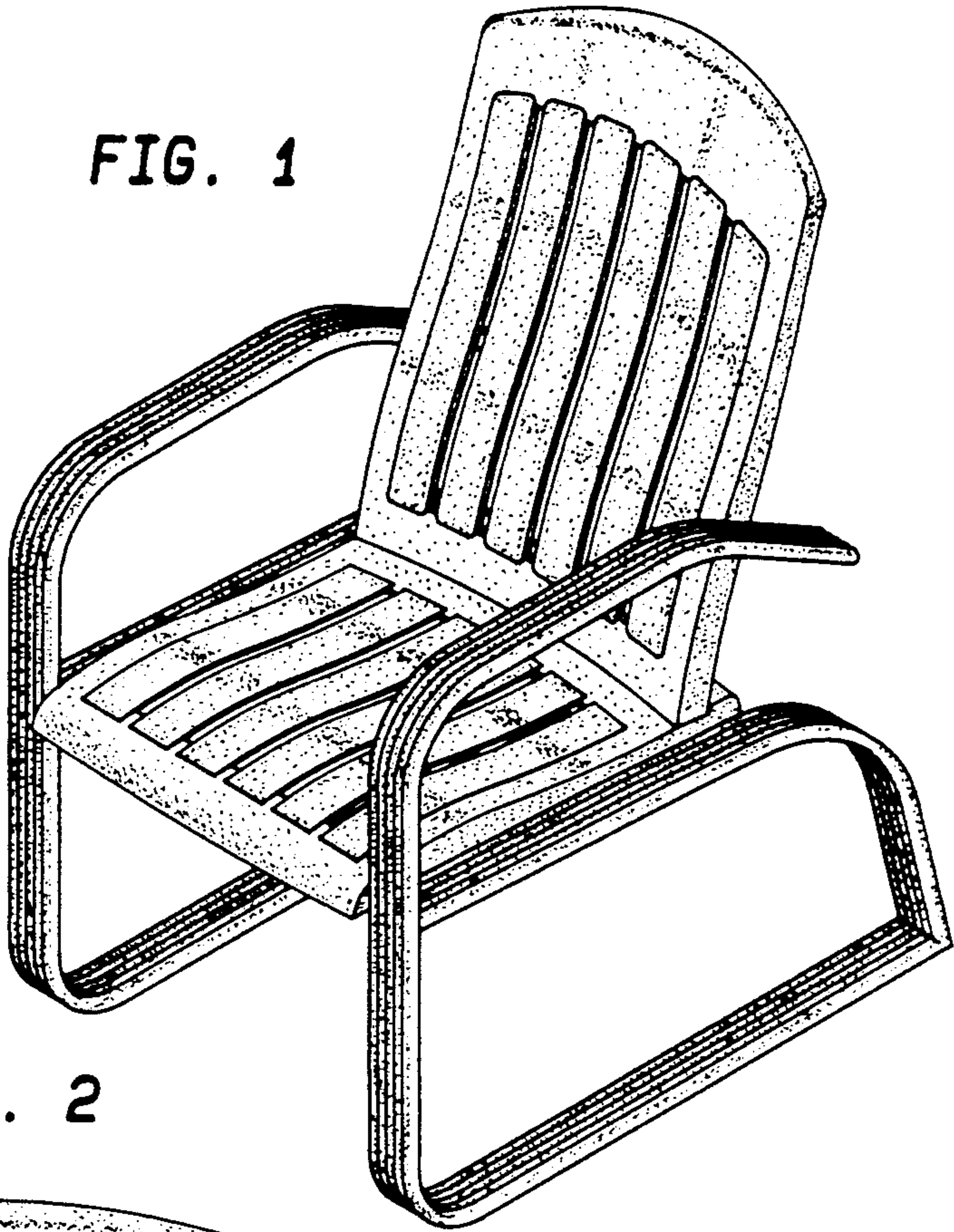

FIG. 2

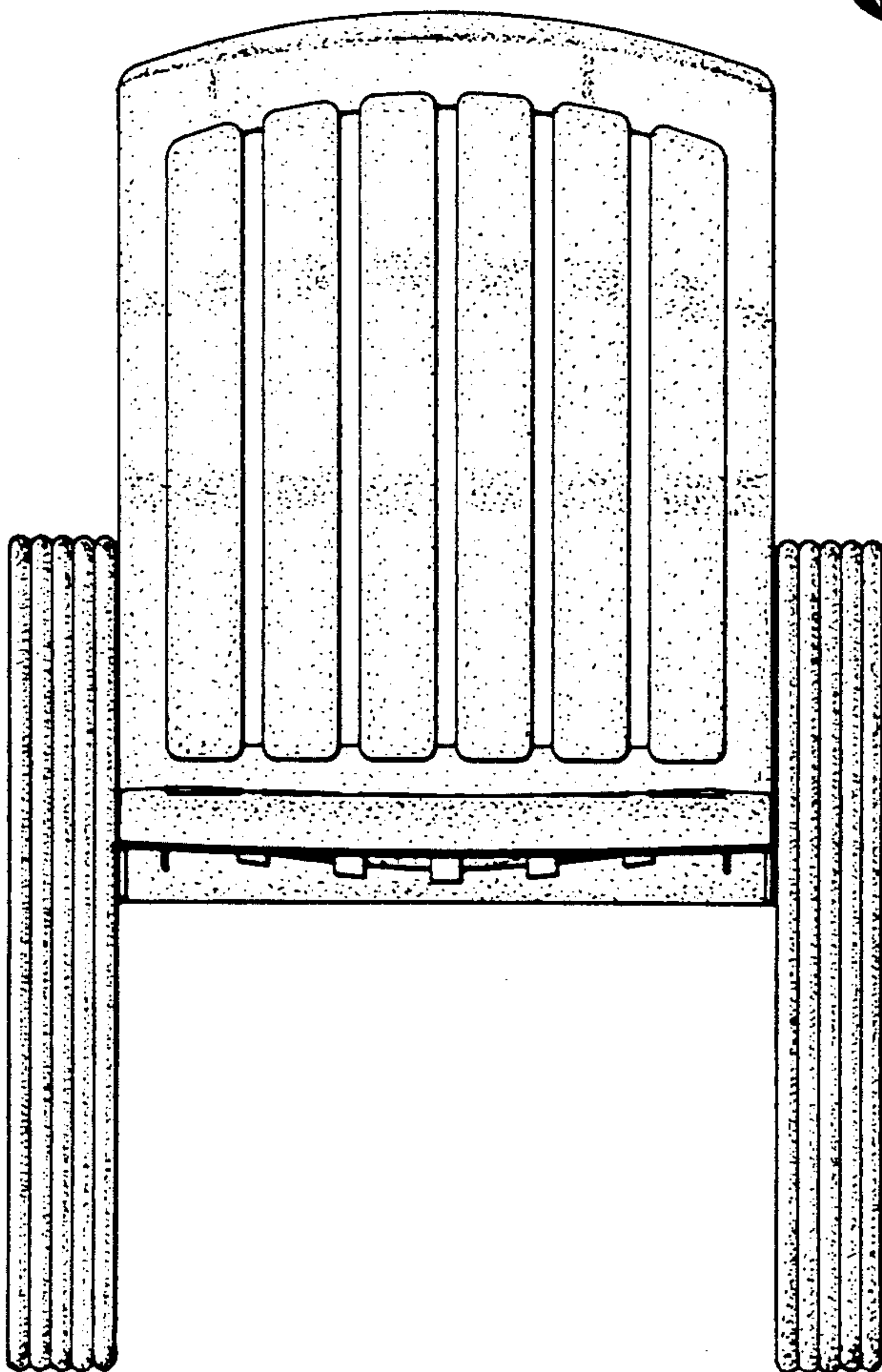



FIG. 3

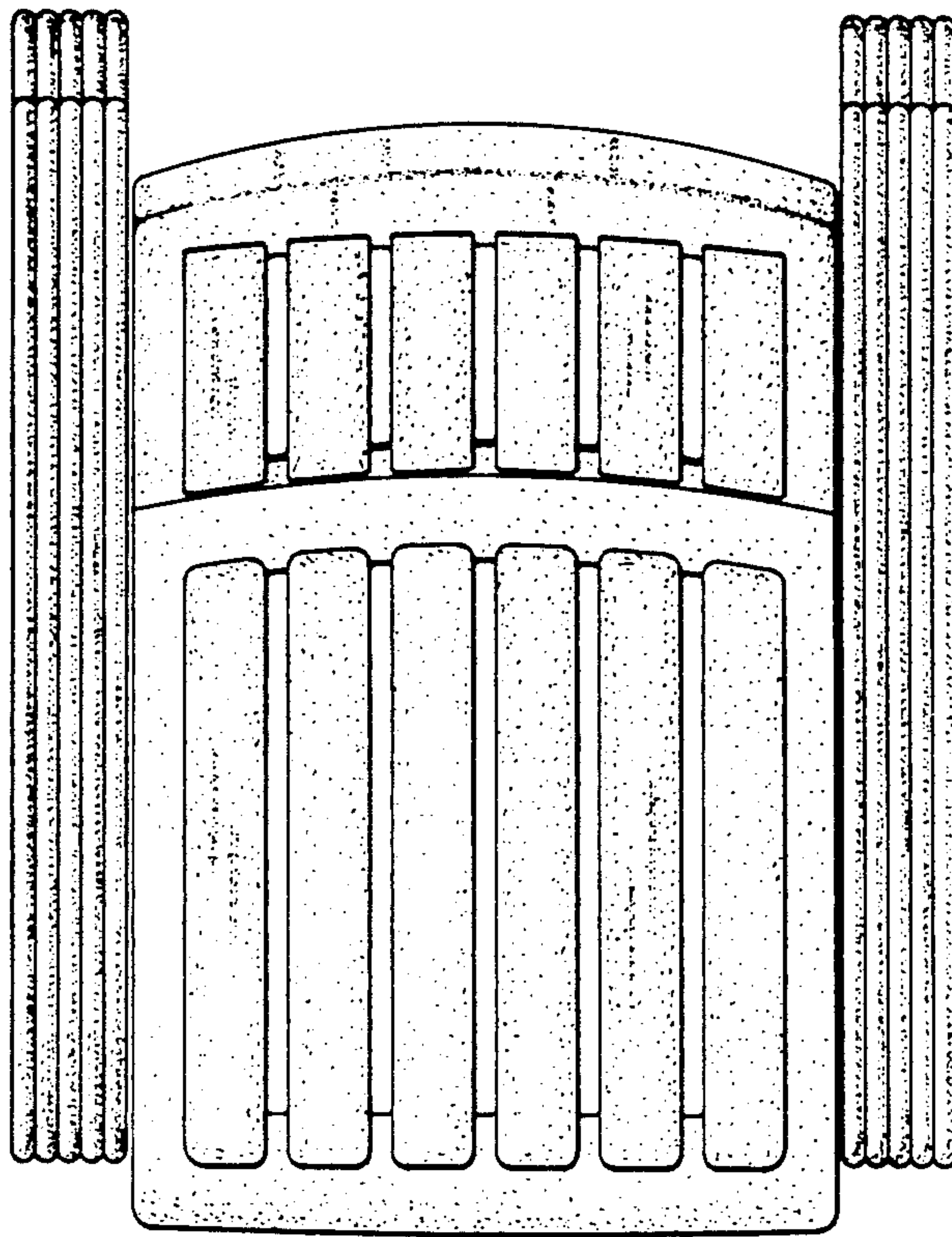

FIG. 4

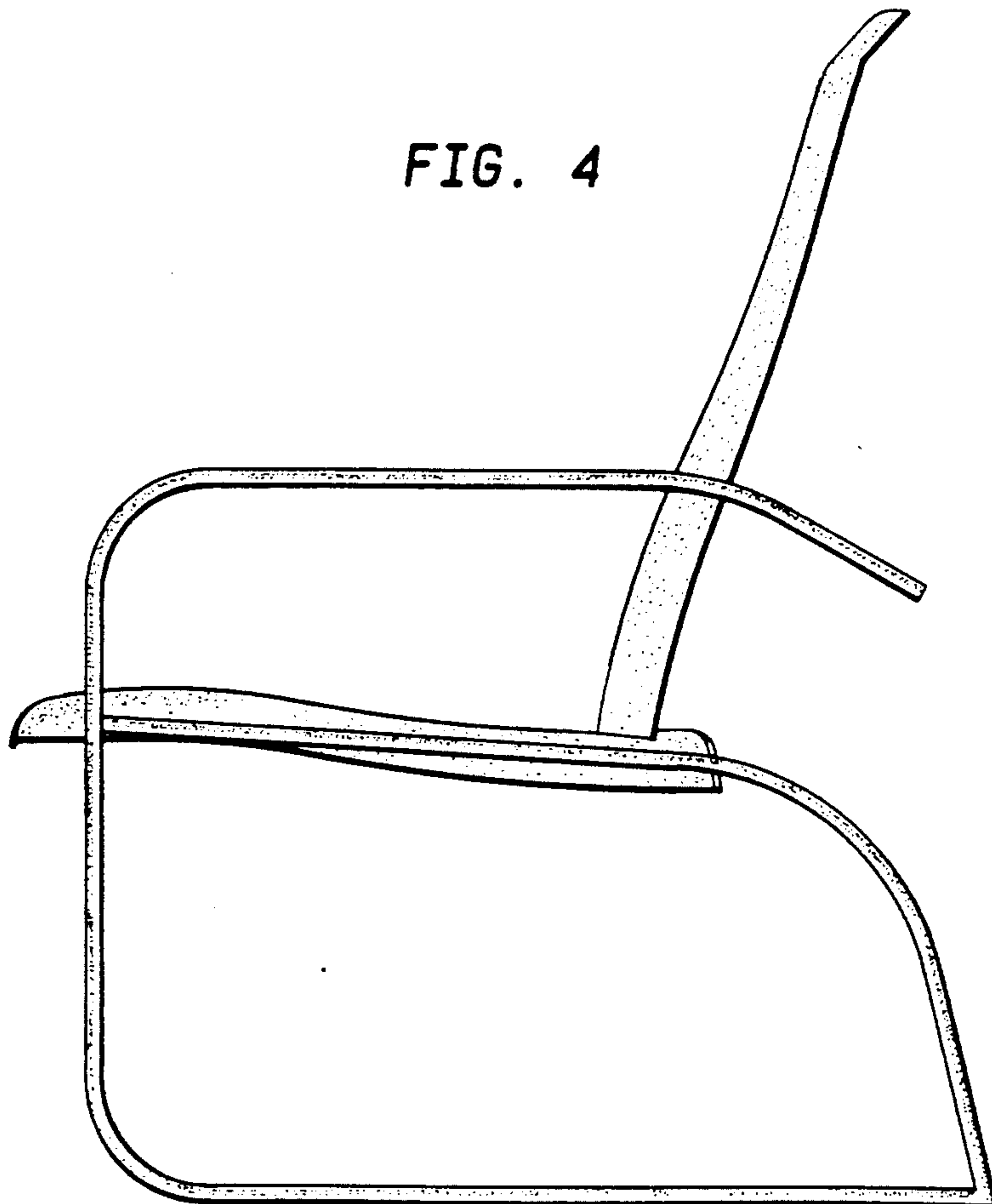

FIG. 5

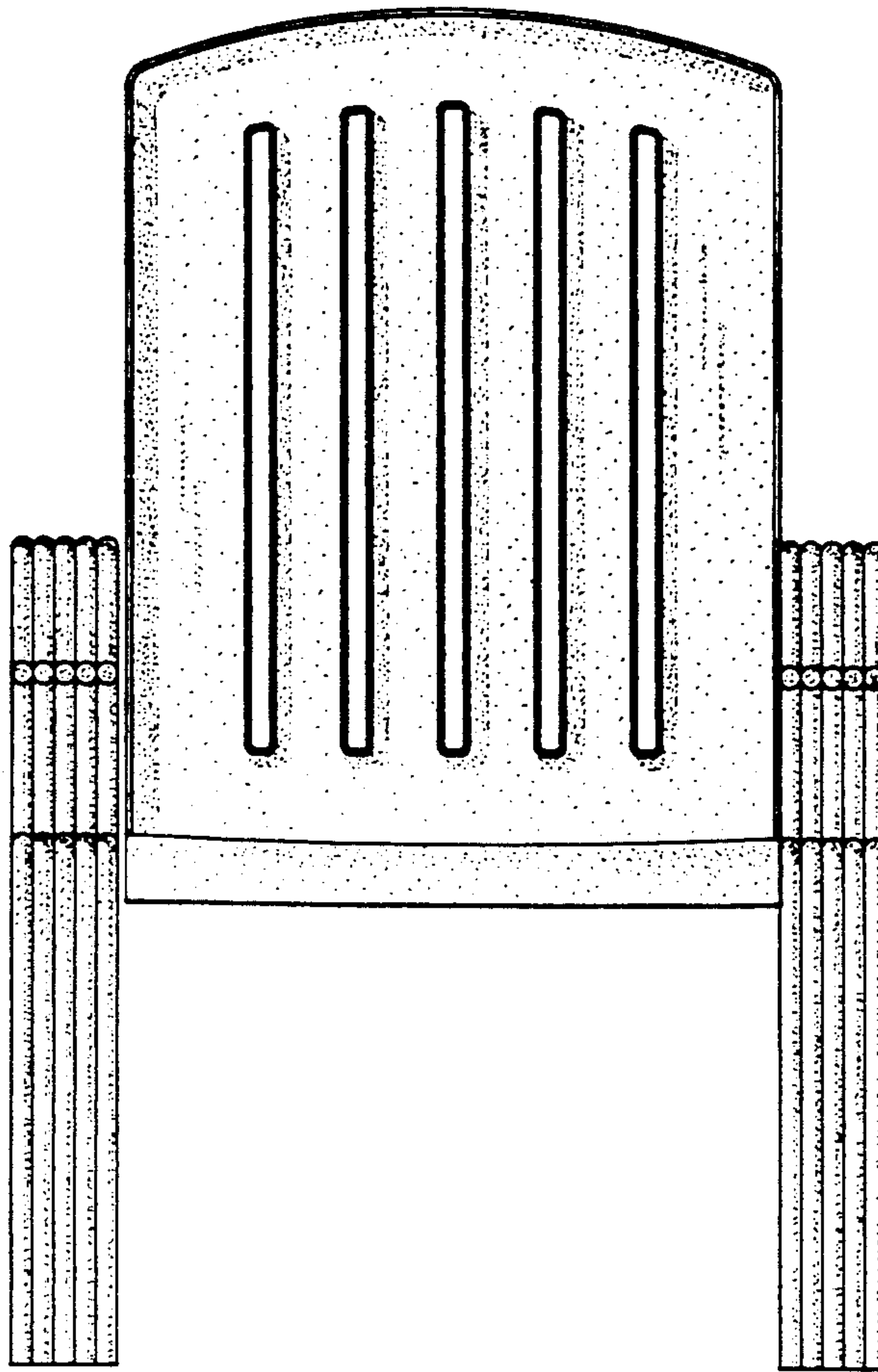

FIG. 6

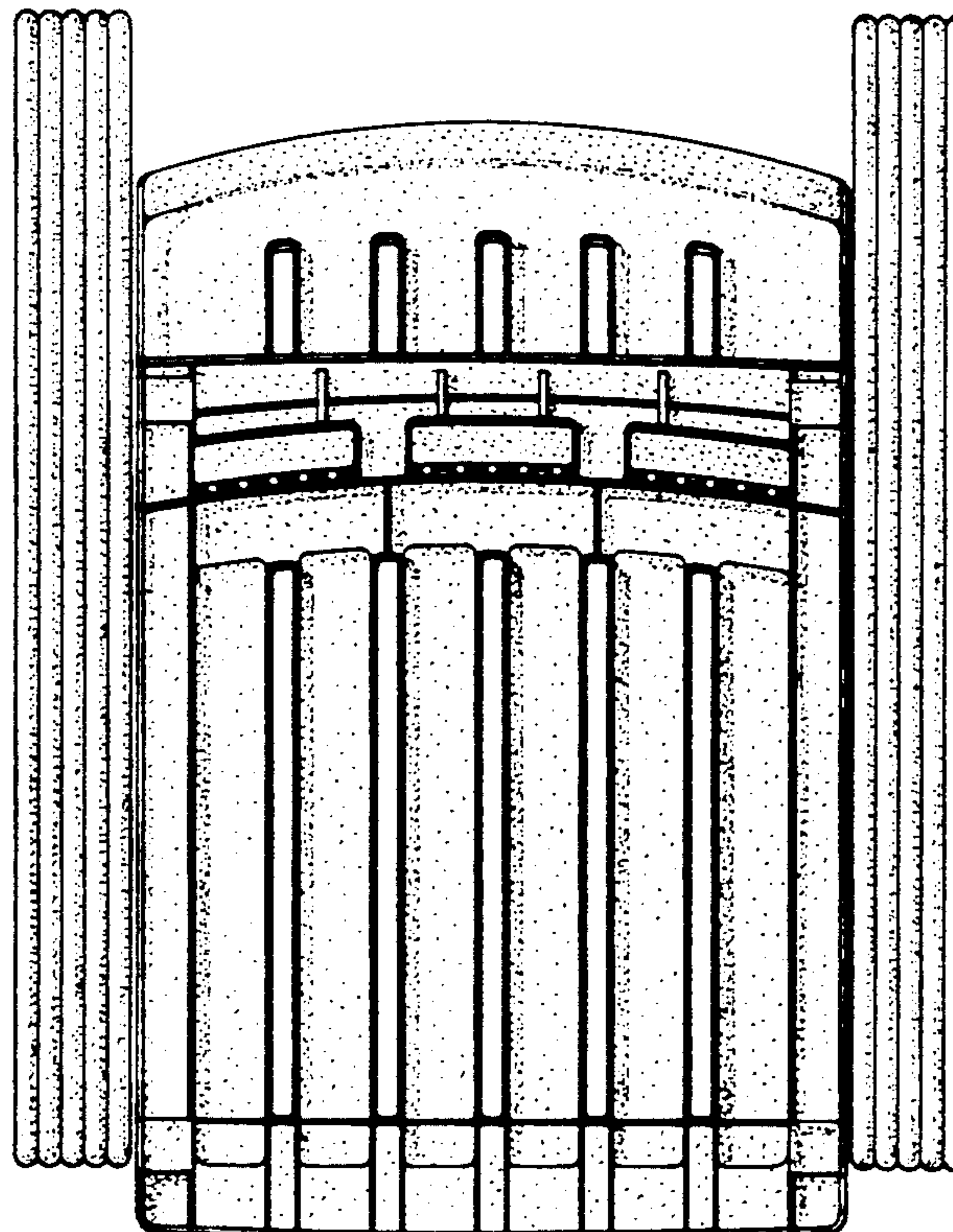

FIG. 7

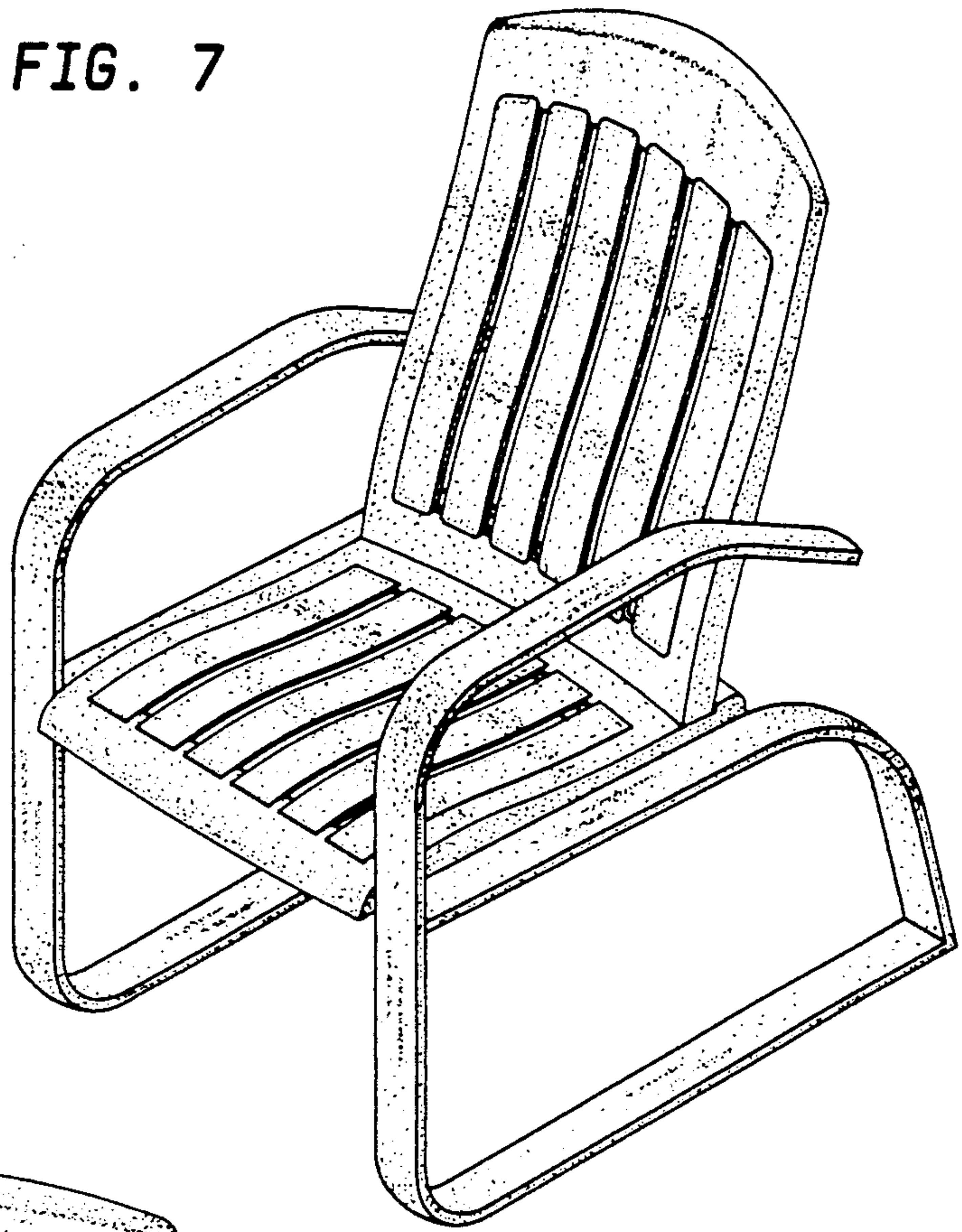

FIG. 8

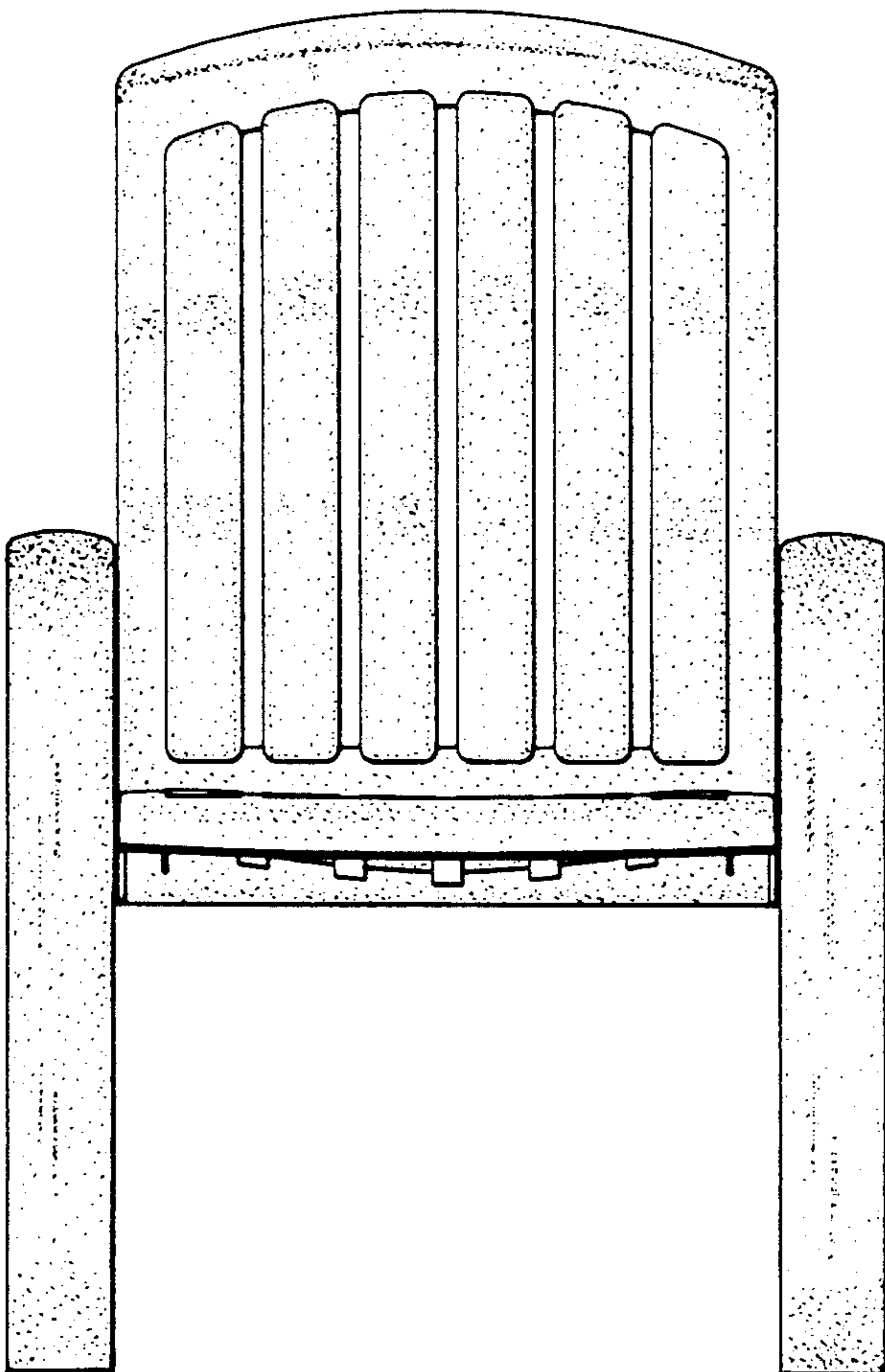



FIG. 9

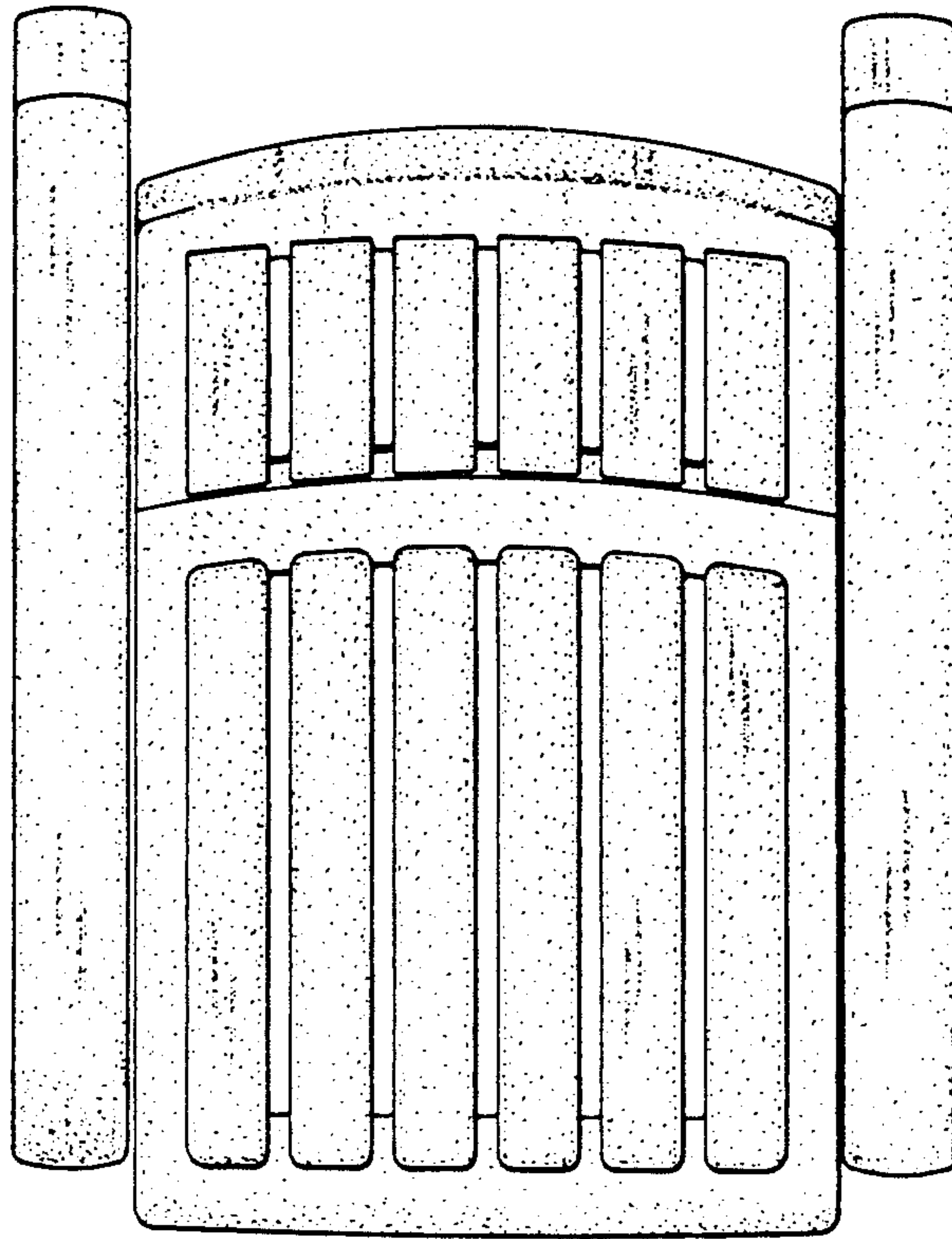

FIG. 10

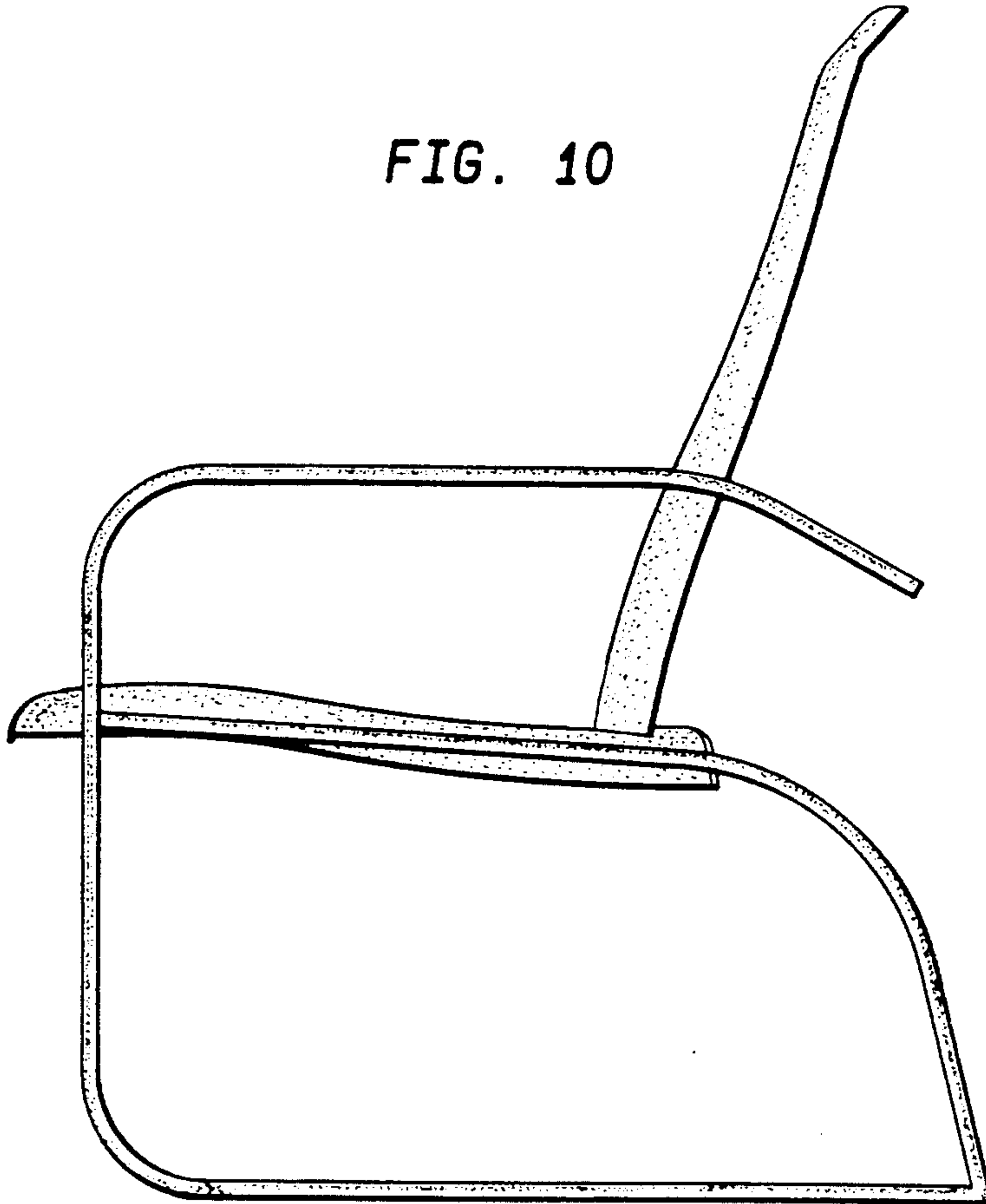

FIG. 11

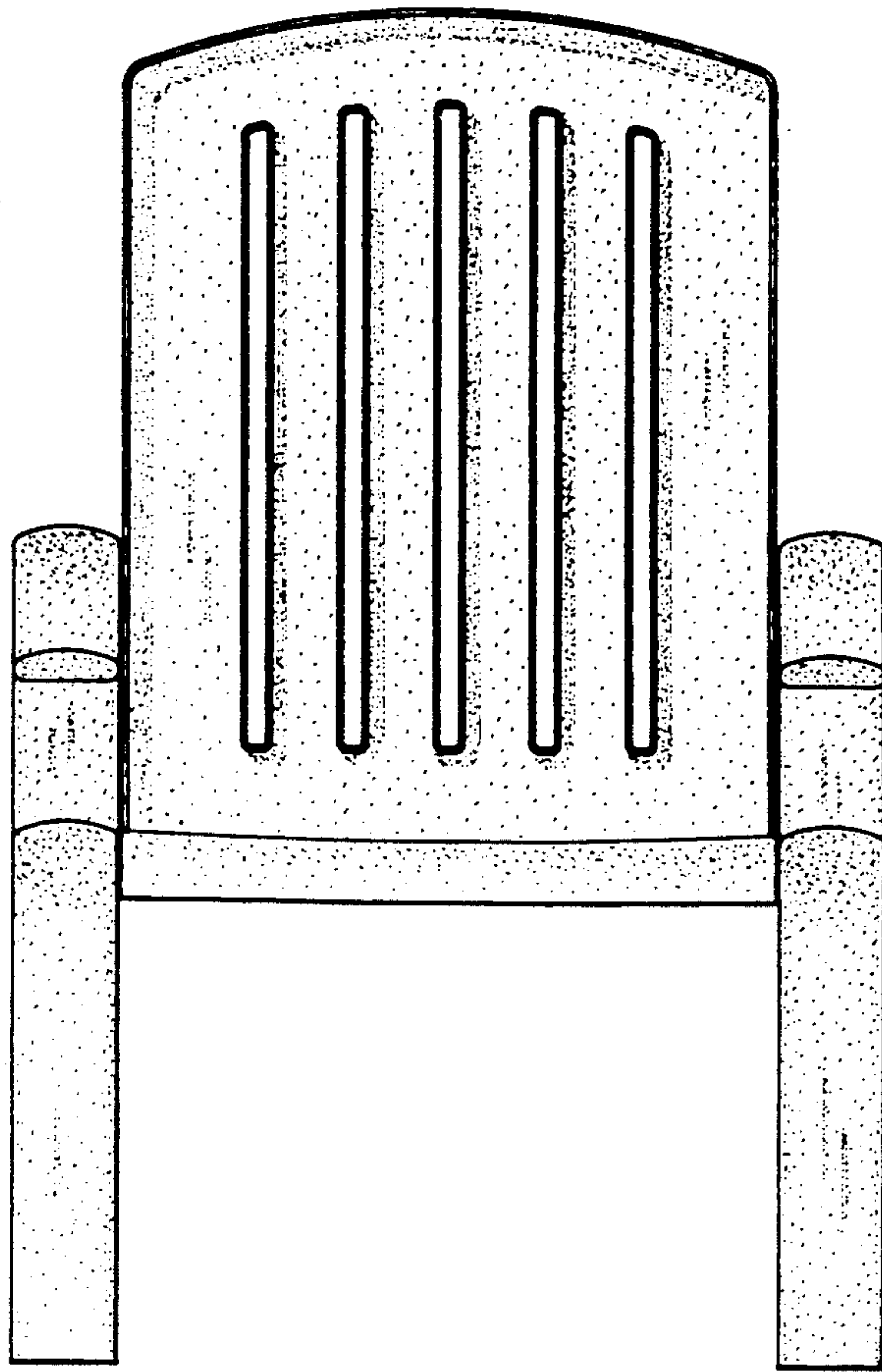

FIG. 12

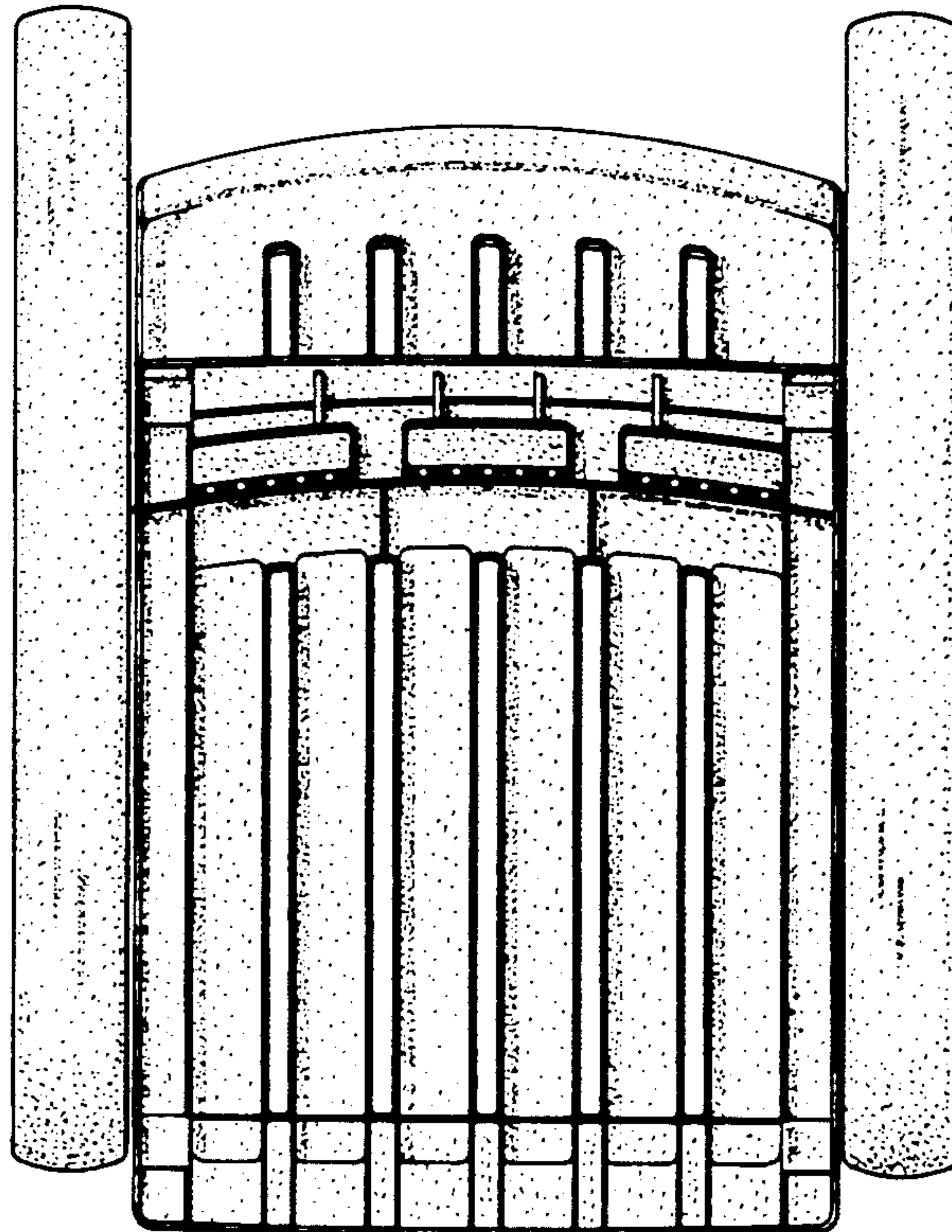



FIG. 13

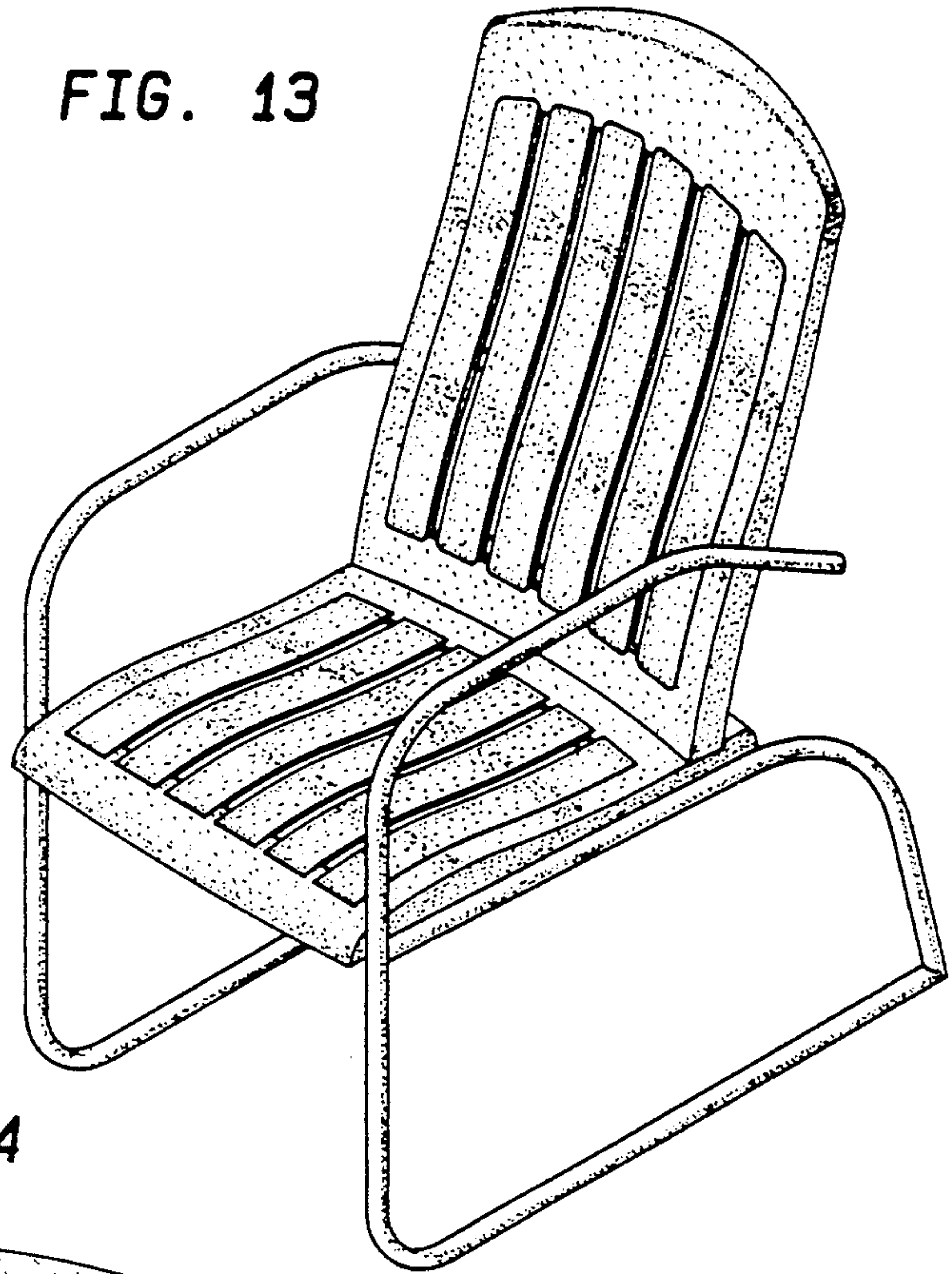

FIG. 14

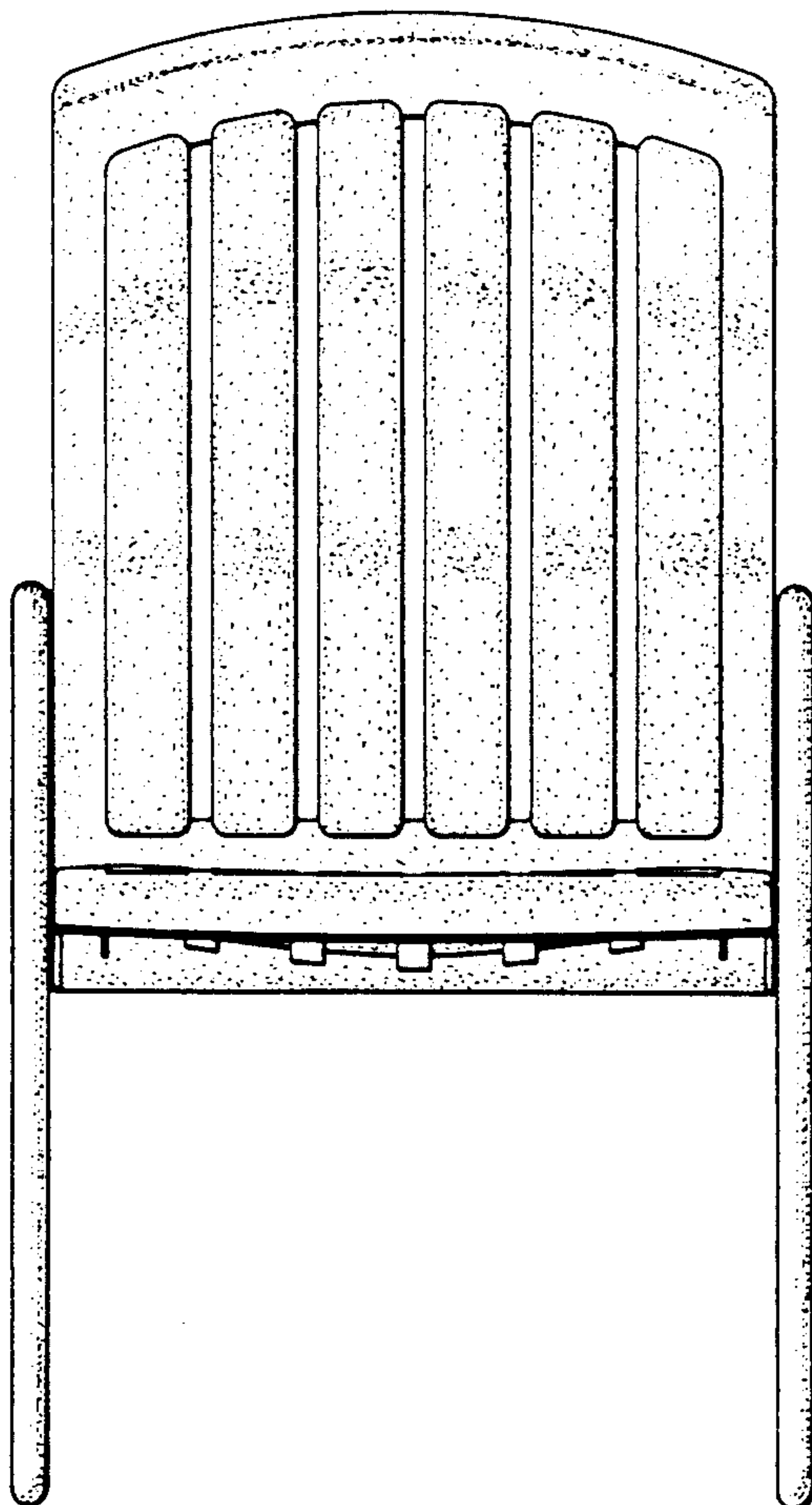

FIG. 15

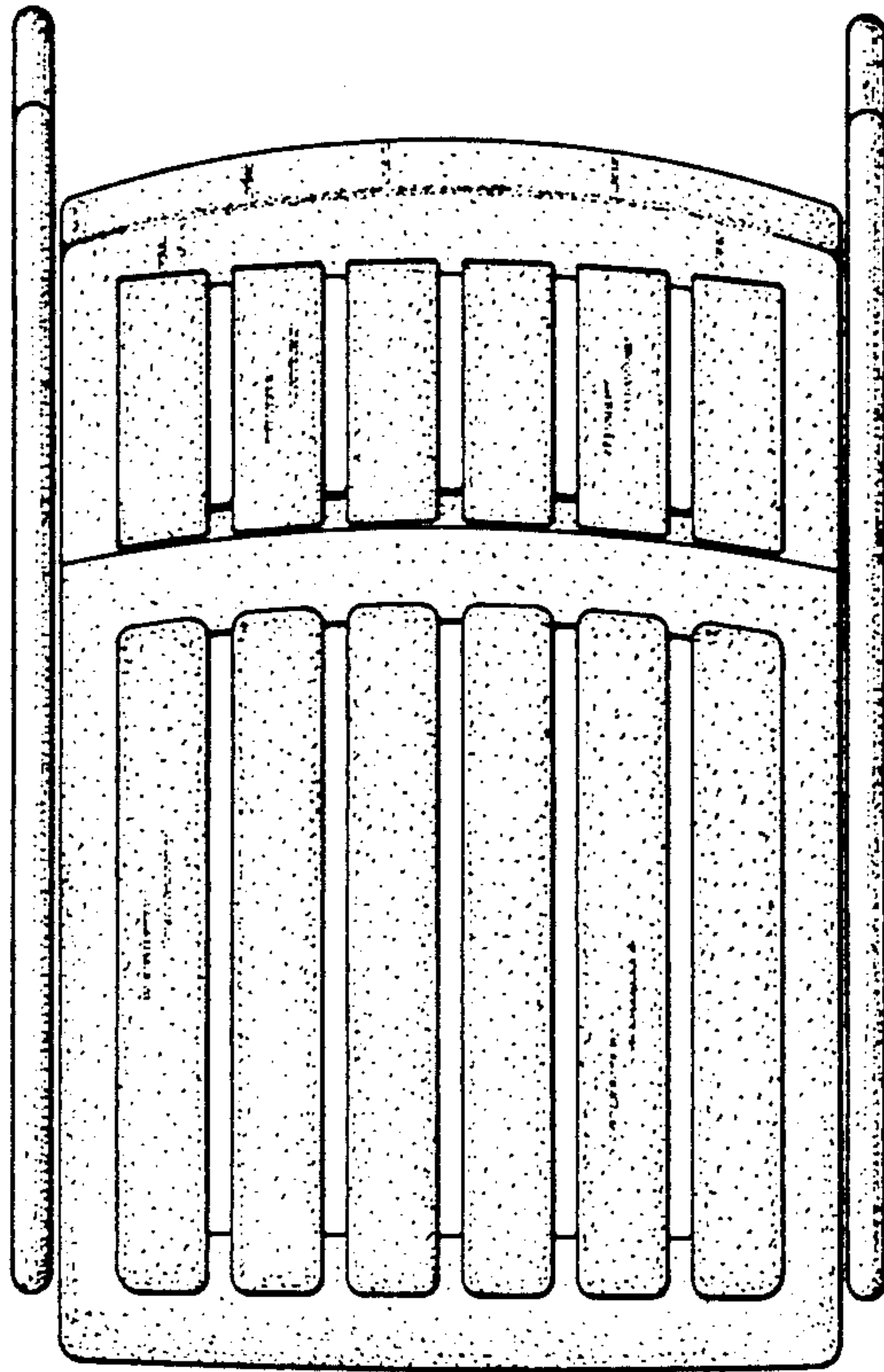

FIG. 16

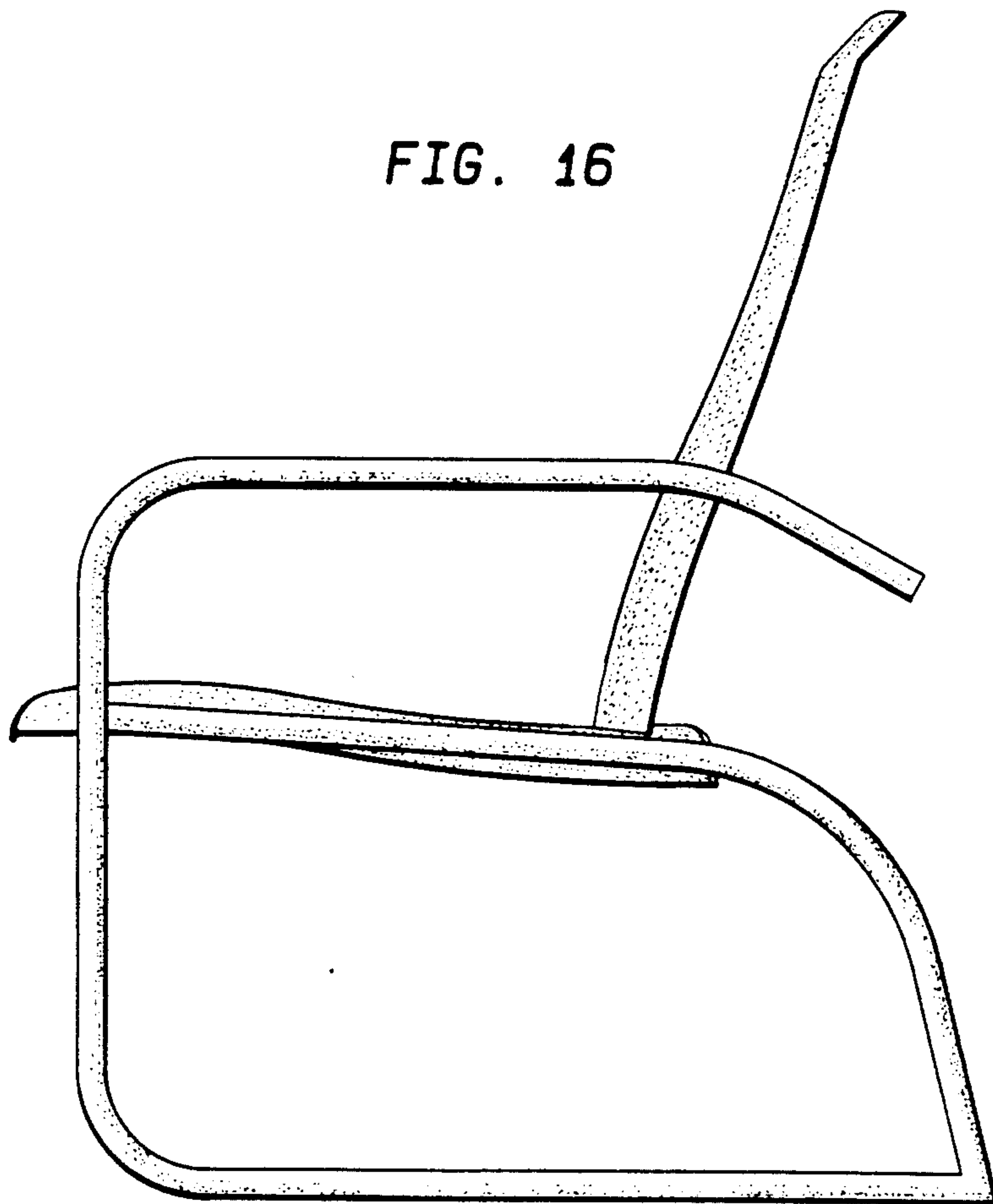

FIG. 17

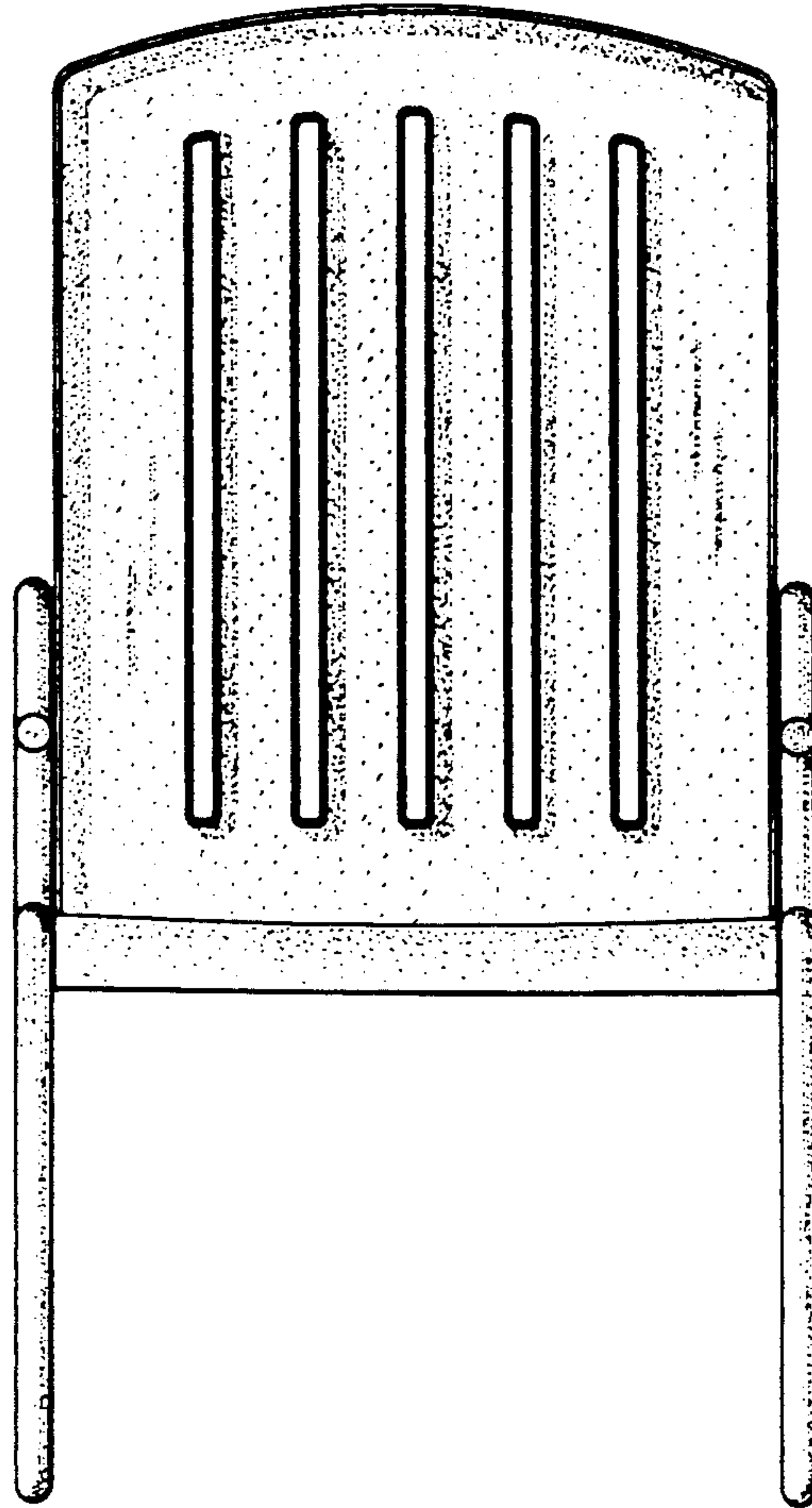

FIG. 18

