



US00D340997S

United States Patent [19]

[11] Patent Number: **Des. 340,997**

Harrison

[45] Date of Patent: **** Nov. 2, 1993**

[54] **RETAINING WALL BLOCK**

4,920,712 5/1990 Dean, Jr. 52/169.4

[75] Inventor: **Cloyce D. Harrison**, Albuquerque, N. Mex.

FOREIGN PATENT DOCUMENTS

1169265 6/1984 Canada .

[73] Assignee: **CSTW, Inc.**, Albuquerque, N. Mex.

Primary Examiner—A. Hugo Word

[**] Term: **14 Years**

Assistant Examiner—Doris Clark

[21] Appl. No.: **936,907**

Attorney, Agent, or Firm—Dennis F. Armijo; Deborah A. Peacock

[22] Filed: **Aug. 27, 1992**

[52] U.S. Cl. **D25/118**

[58] Field of Search **D25/114, 115, 118; 52/590-596, 602, 605, 608, 610; 485/284, 286, 272; D21/108**

[57] **CLAIM**

The ornamental design for a retaining wall block, as shown and described.

DESCRIPTION

[56] **References Cited**

U.S. PATENT DOCUMENTS

D. 295,788	5/1988	Forsberg	D25/113
D. 295,790	5/1988	Forsberg	D25/116
D. 296,007	5/1988	Forsberg	D25/116
D. 296,365	6/1988	Forsberg	D25/116
D. 297,464	8/1988	Forsberg	D25/114
D. 297,574	9/1988	Forsberg	D25/114
D. 297,767	9/1988	Forsberg	D25/58
D. 298,463	11/1988	Forsberg	D25/114
D. 299,067	12/1988	Forsberg	D25/58
D. 300,253	3/1989	Forsberg	D25/114
D. 300,254	3/1989	Forsberg	D25/114
D. 301,064	5/1989	Forsberg	D25/116
D. 311,444	10/1990	Forsberg	D25/113
2,022,590	11/1935	Dziarski	52/605
2,610,503	9/1952	Hall	D25/118
2,624,193	1/1953	Larson	D25/118
4,335,549	6/1982	Dean, Jr.	52/98
4,627,209	12/1986	Schwartz	52/593
4,914,876	4/1990	Forsberg	52/169.4

FIG. 1 is a right side perspective view of a first embodiment of the retaining wall block of my new design; FIG. 2 is a left side perspective view thereof; FIG. 3 is a top view thereof; FIG. 4 is a front elevational view thereof; FIG. 5 is a side view of the right side thereof; FIG. 6 is a side view of the left side thereof; FIG. 7 is a rear elevational view thereof; FIG. 8 is a bottom view thereof; FIG. 9 is a right side perspective view of a second embodiment of the retaining wall block of my new design; FIG. 10 is a left side perspective view of the embodiment of FIG. 9; FIG. 11 is a top view of FIG. 9; FIG. 12 is a front elevational view of FIG. 9; FIG. 13 is a side view of the right side of FIG. 9; FIG. 14 is a side view of the left side of FIG. 9; FIG. 15 is a rear elevational view of FIG. 9; and, FIG. 16 is a bottom view of FIG. 9.

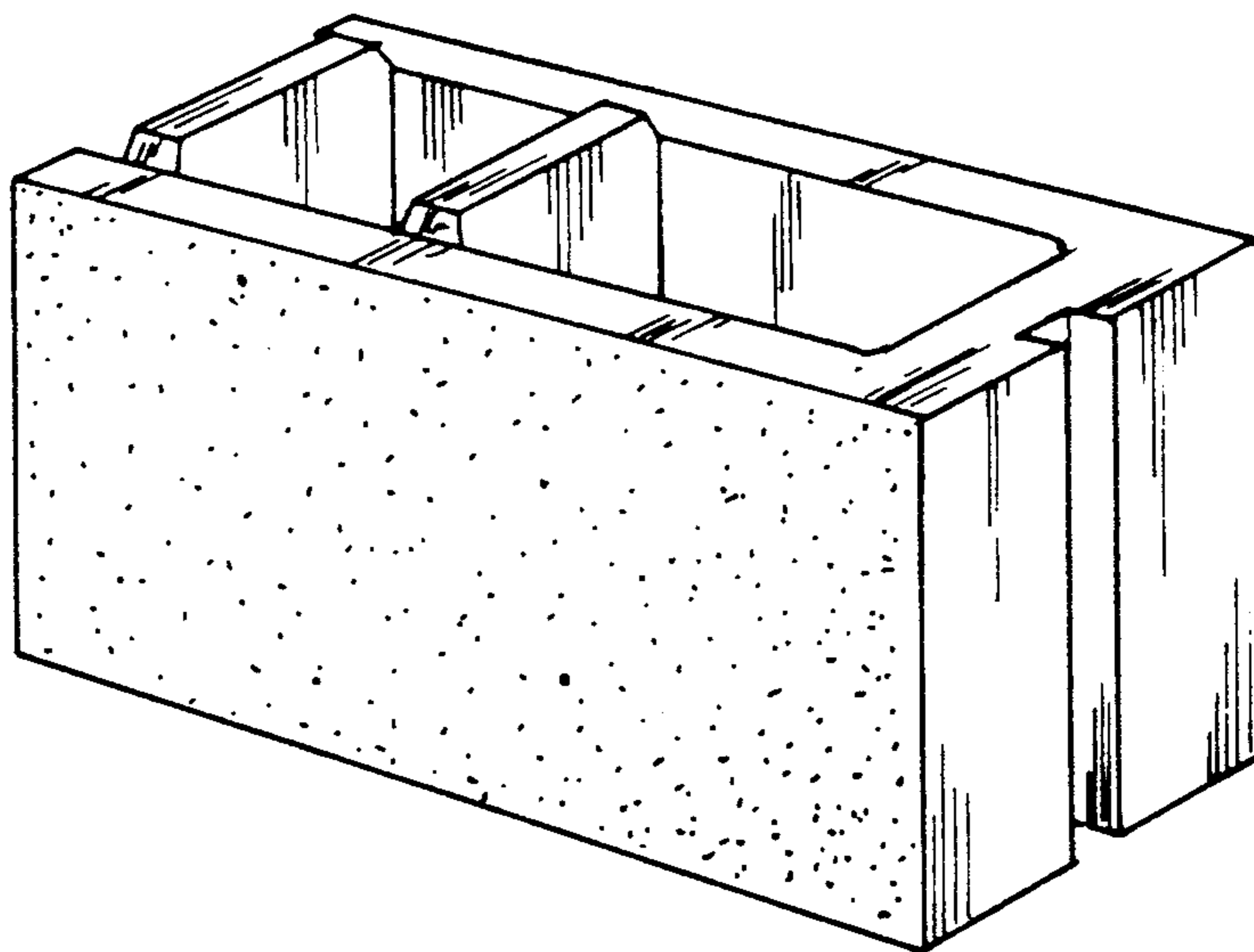

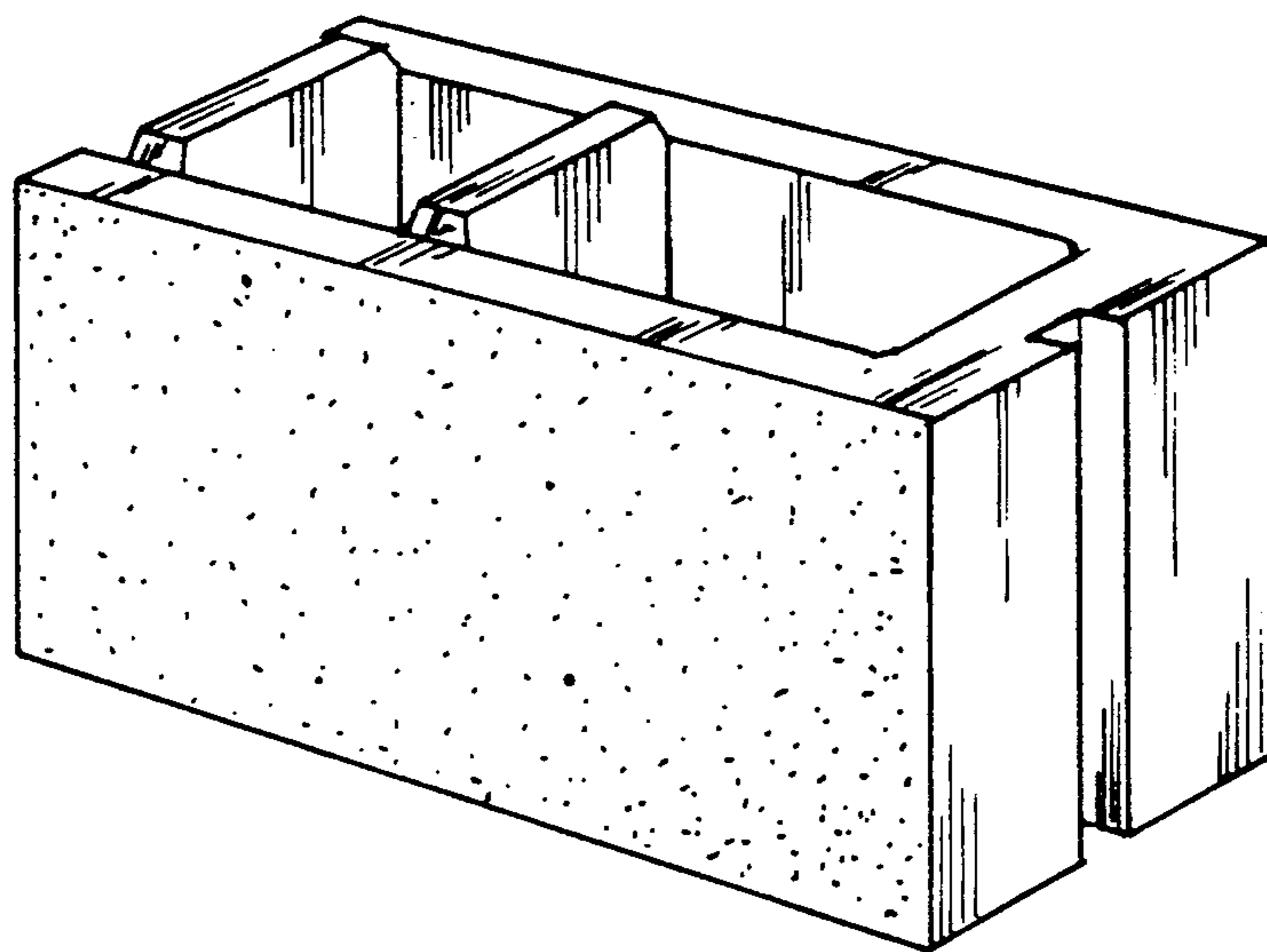

FIG-1

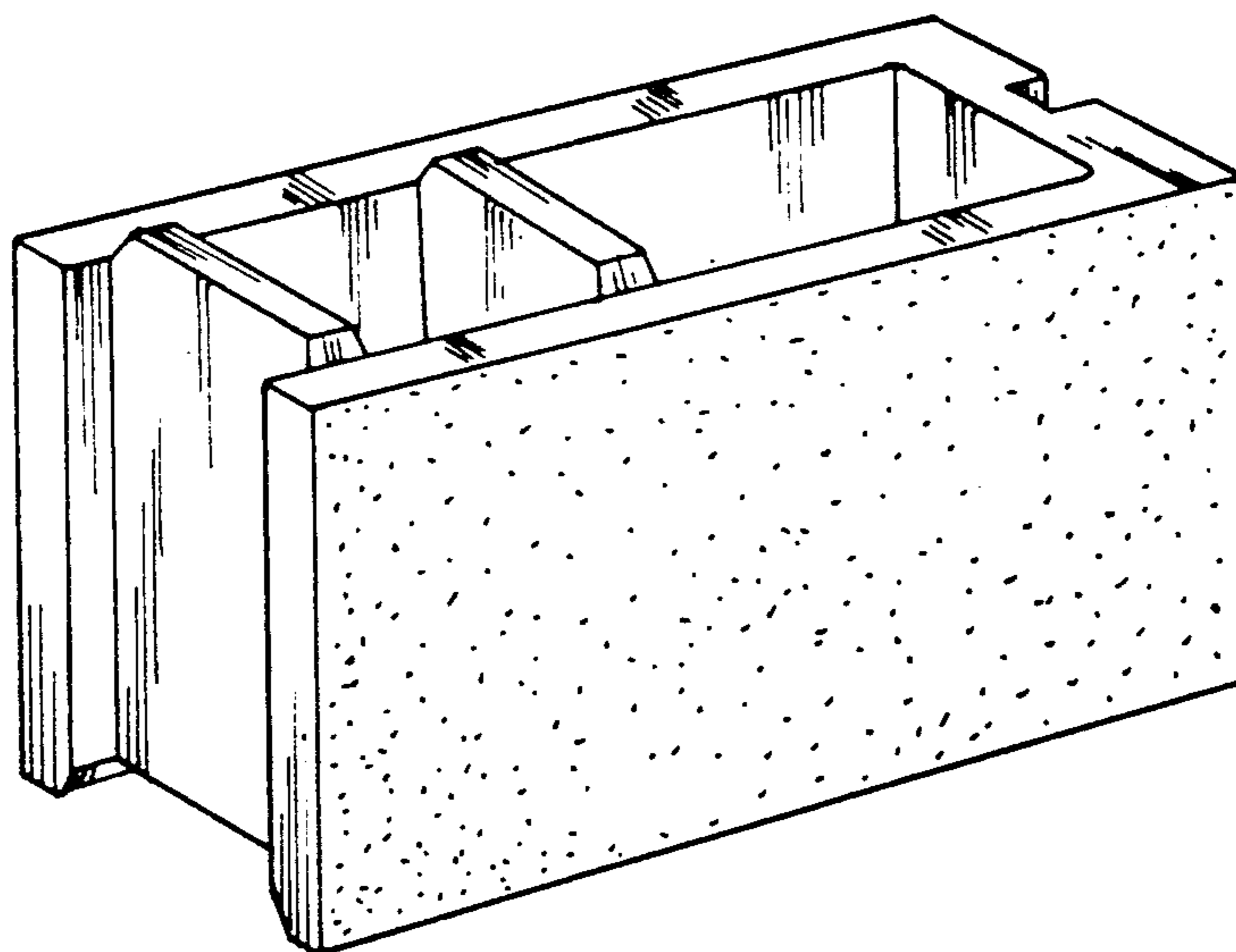

FIG-2

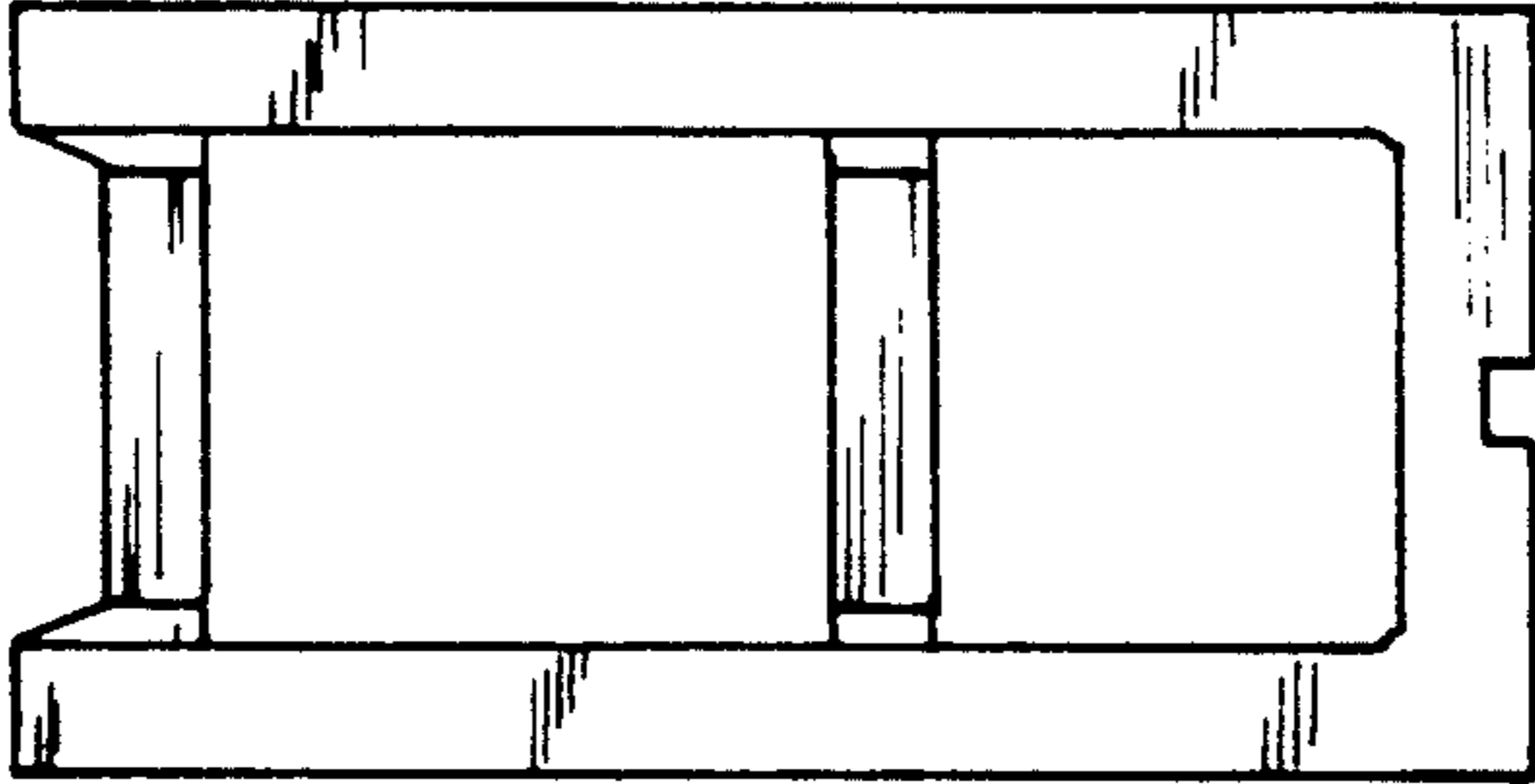

FIG-3

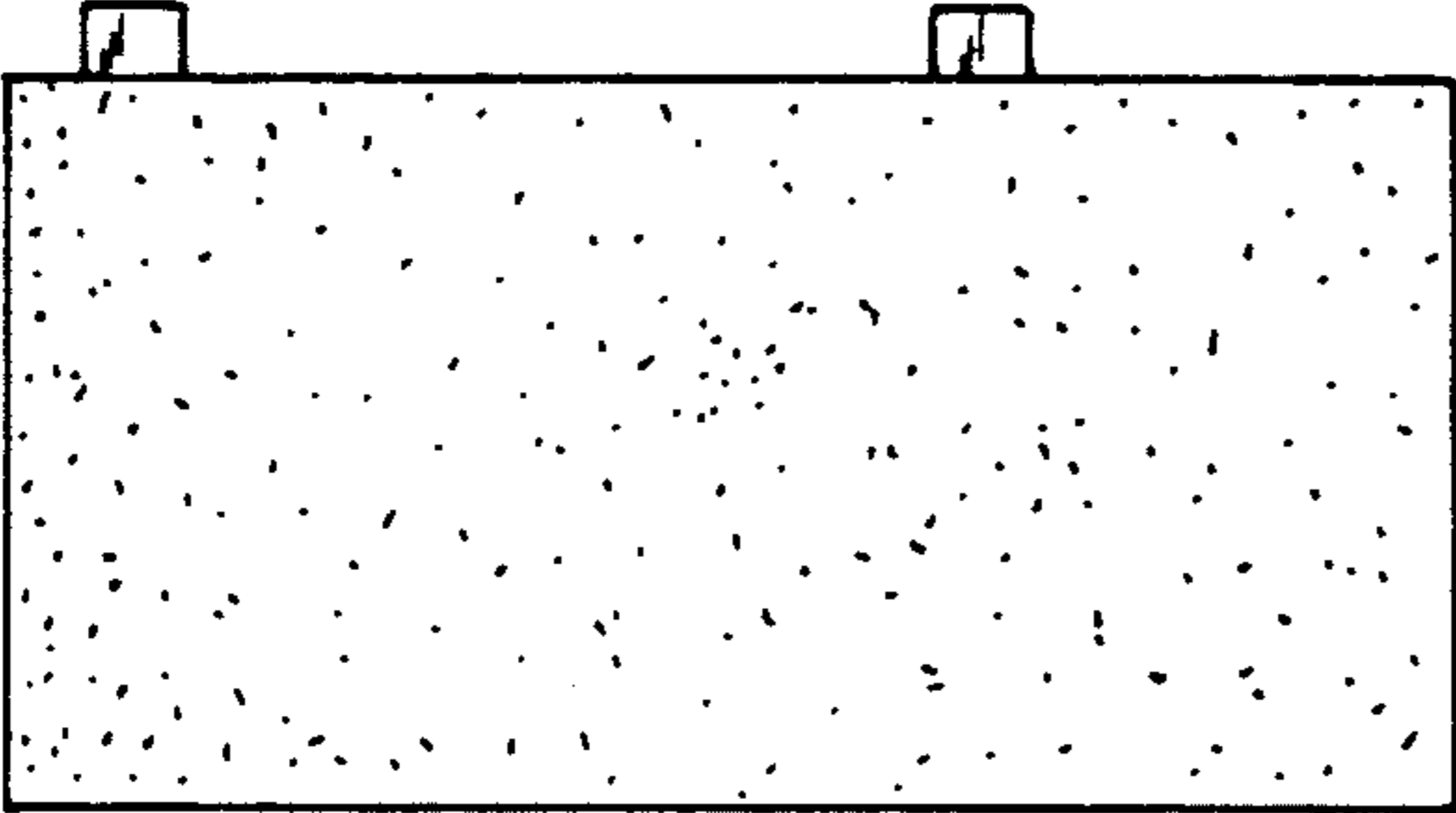

FIG-4

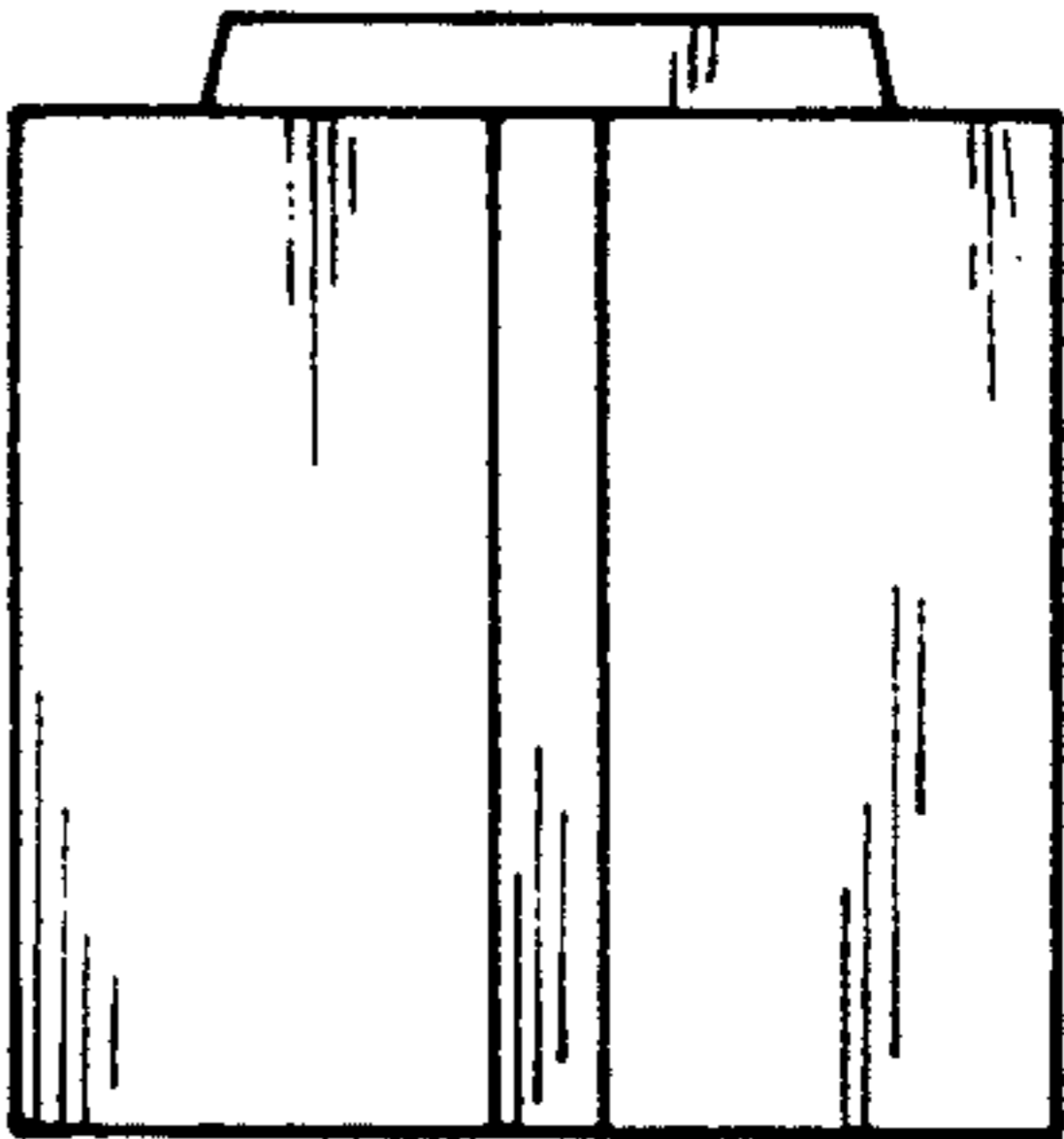

FIG-5

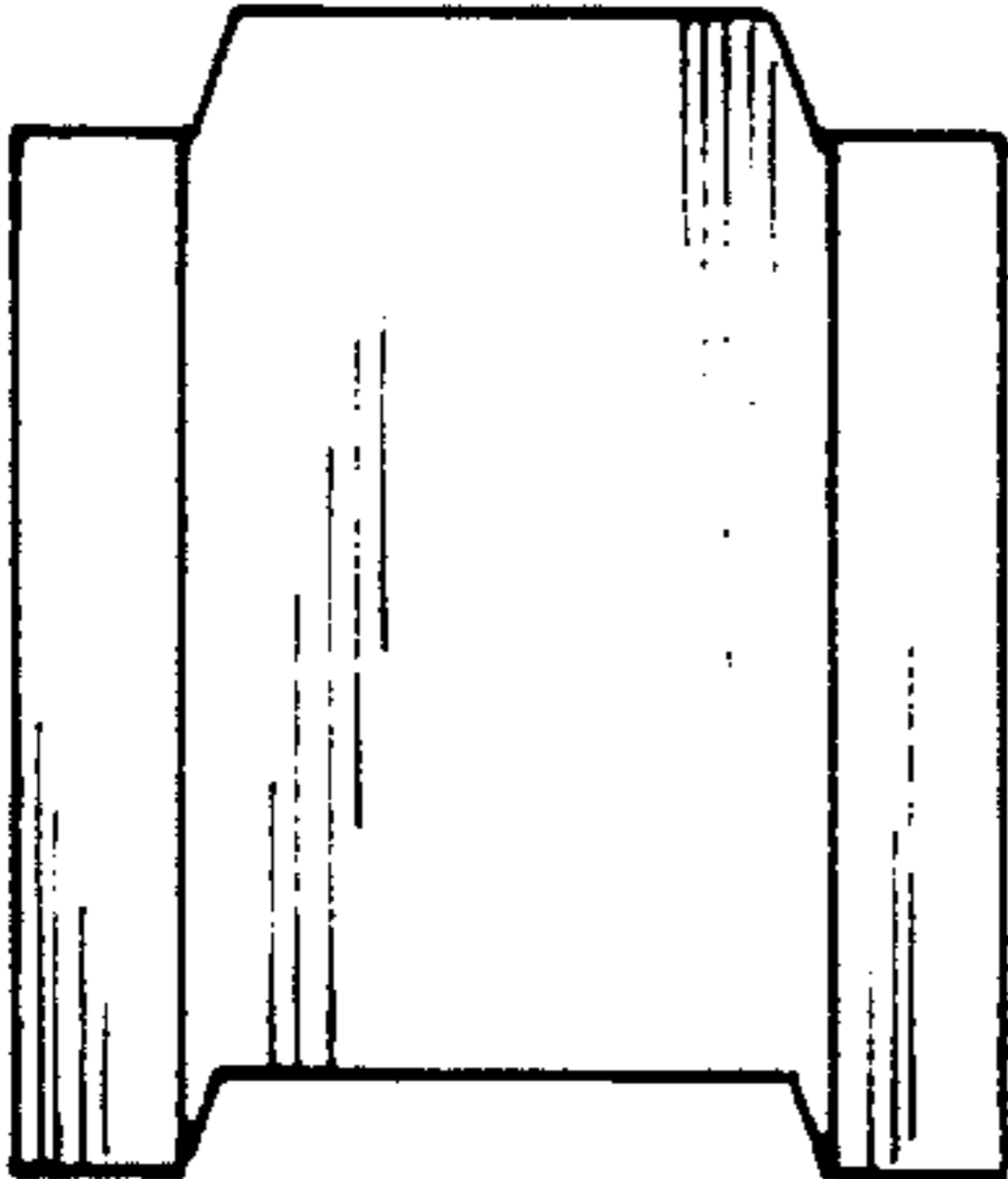

FIG-6

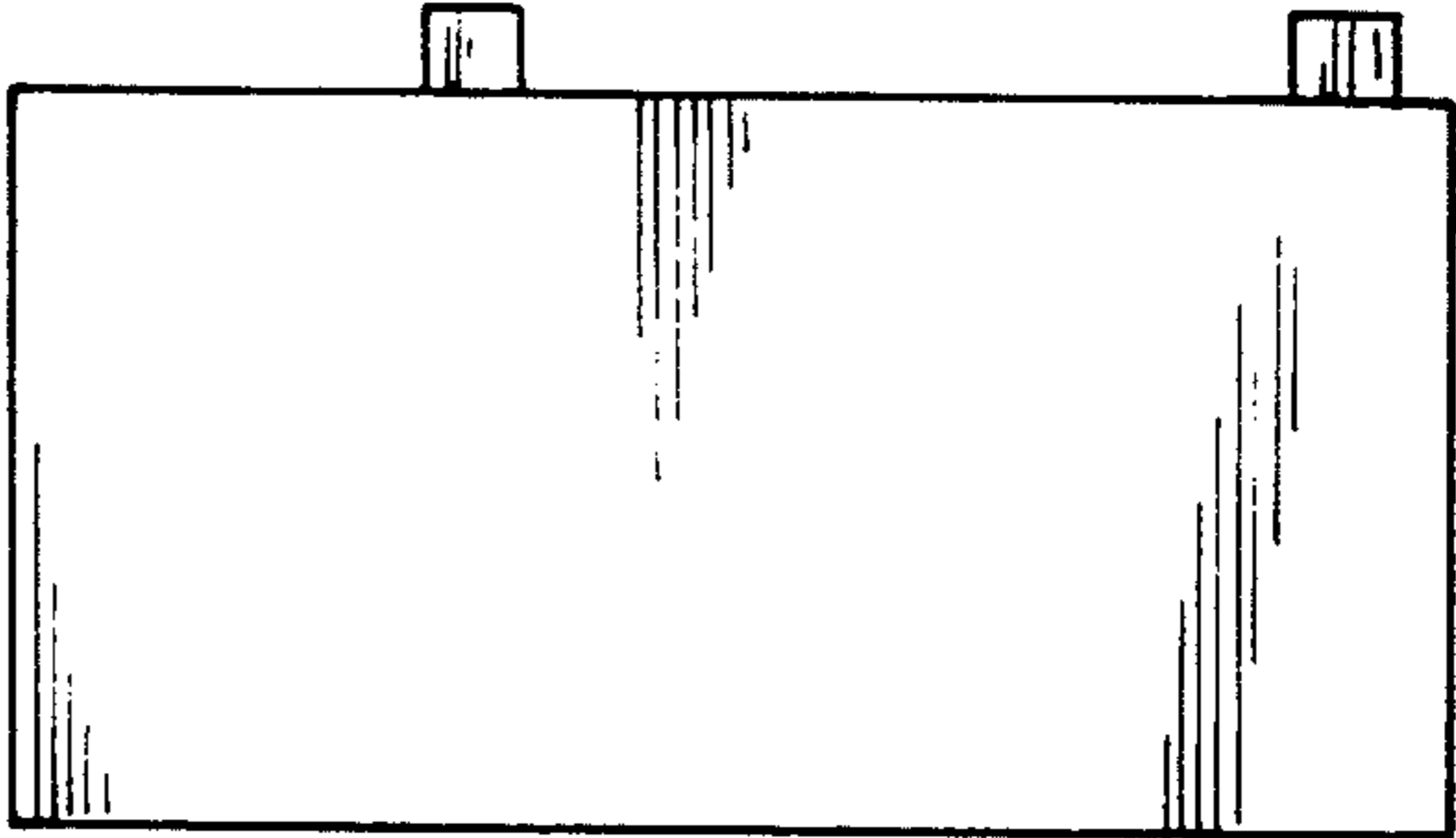

FIG-7

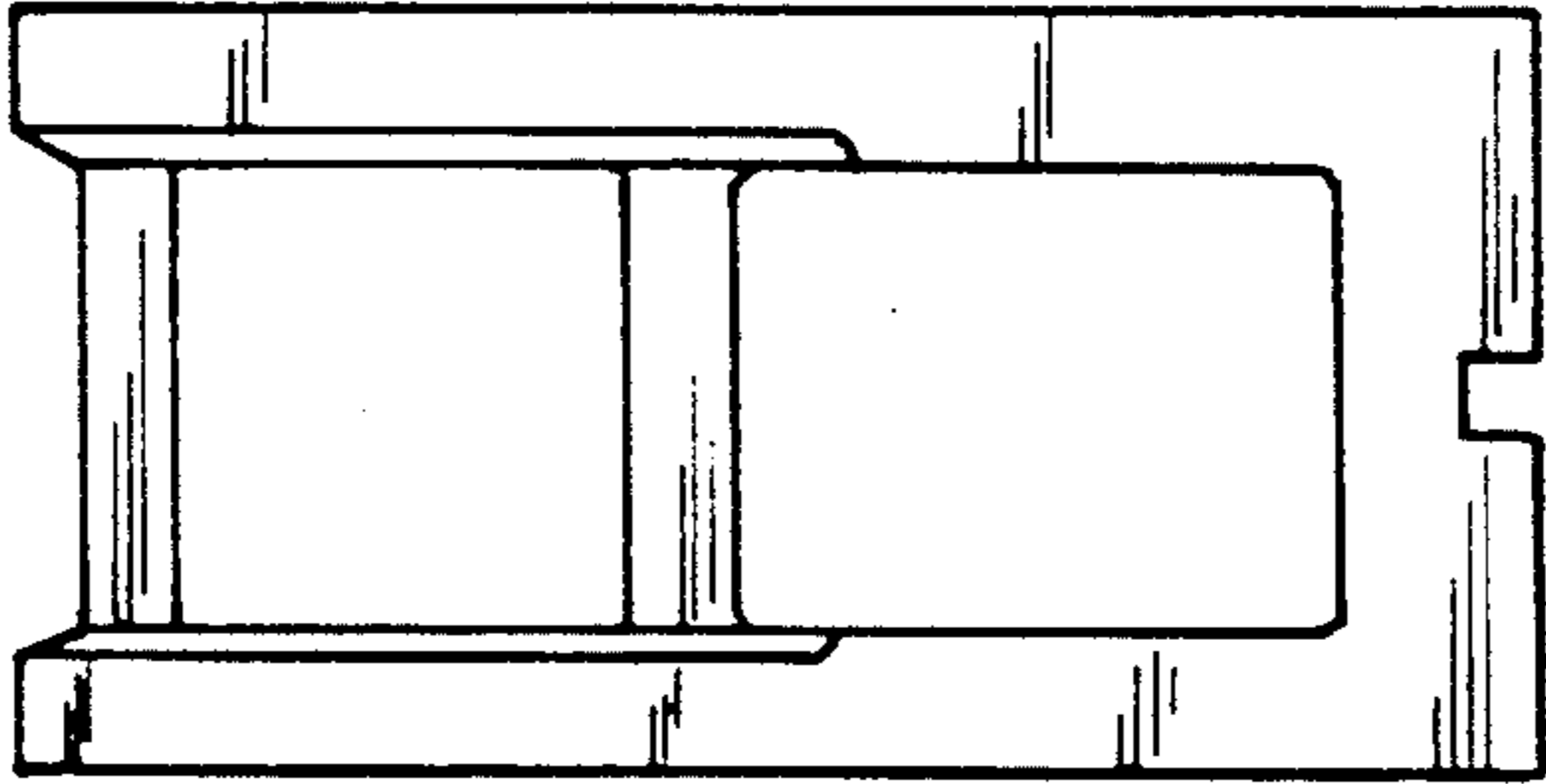

FIG-8

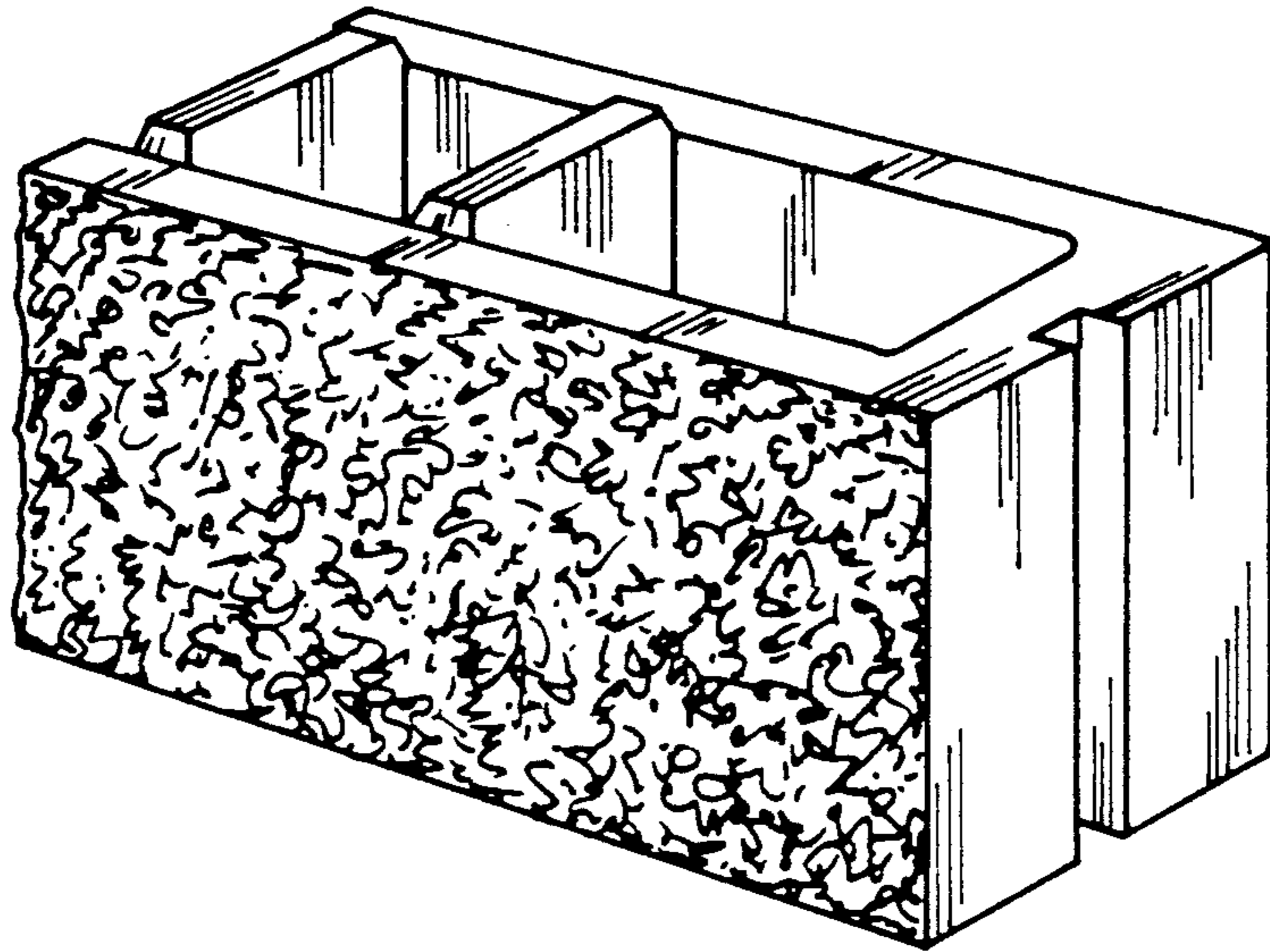

FIG - 9

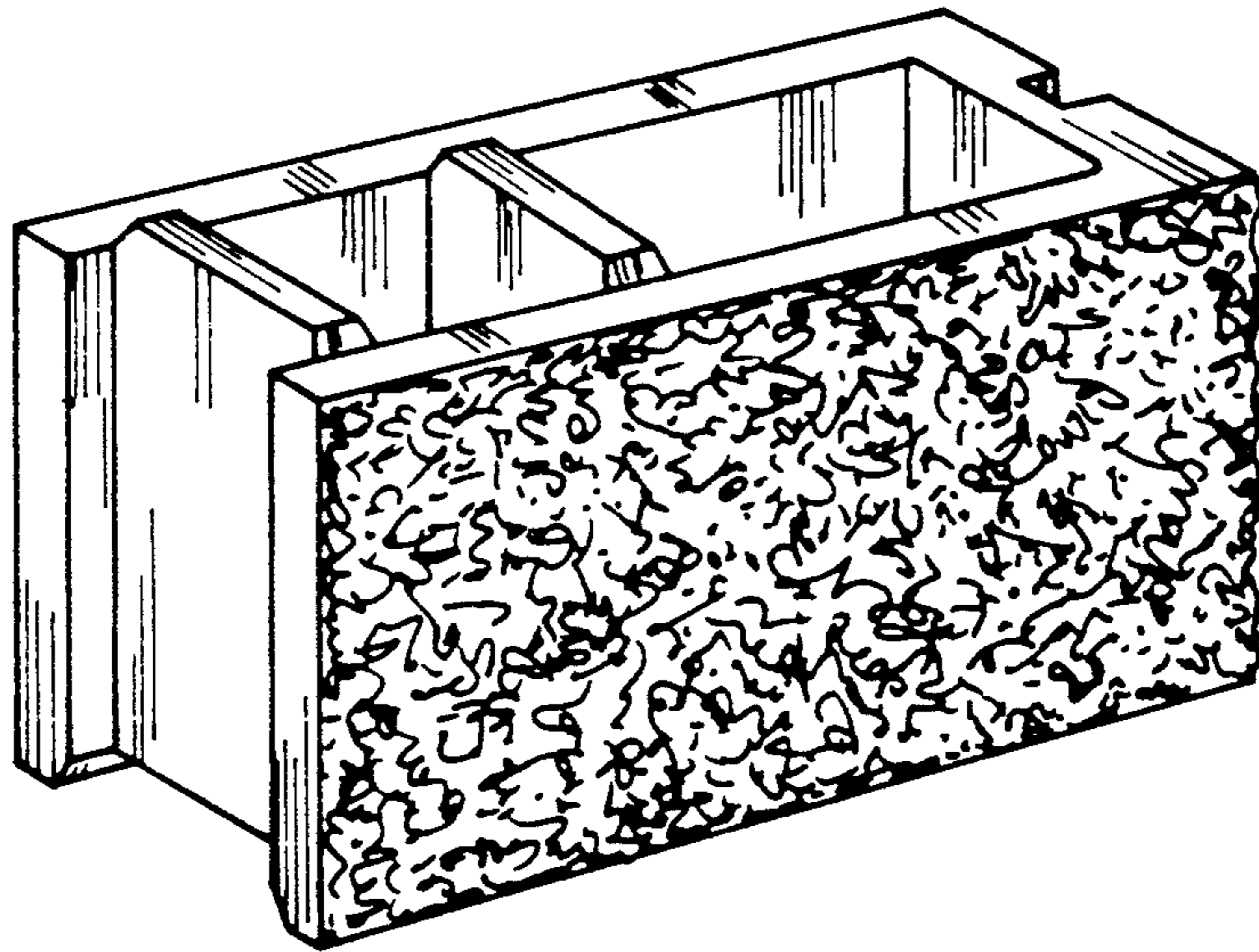

FIG - 10

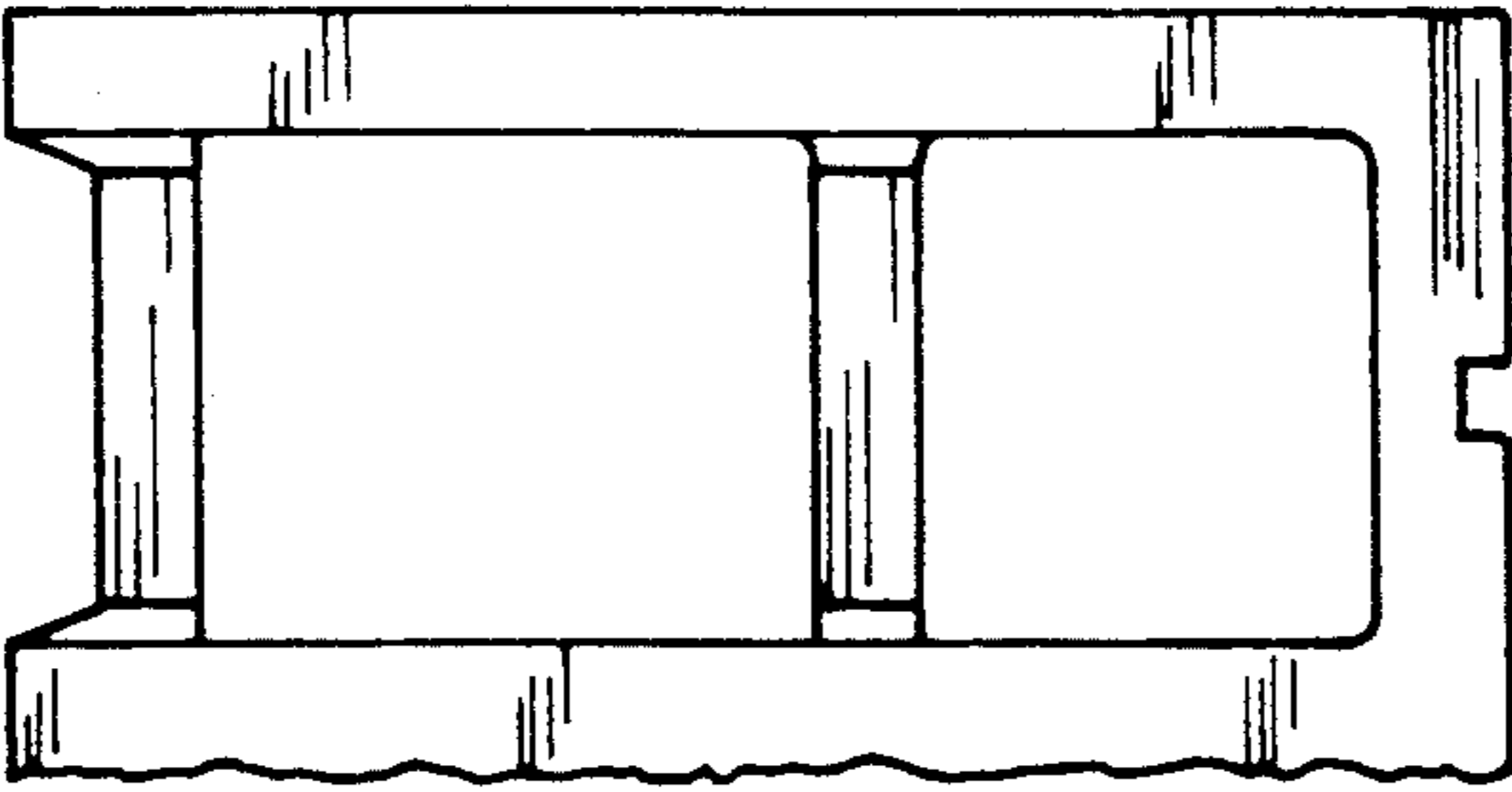

FIG-11

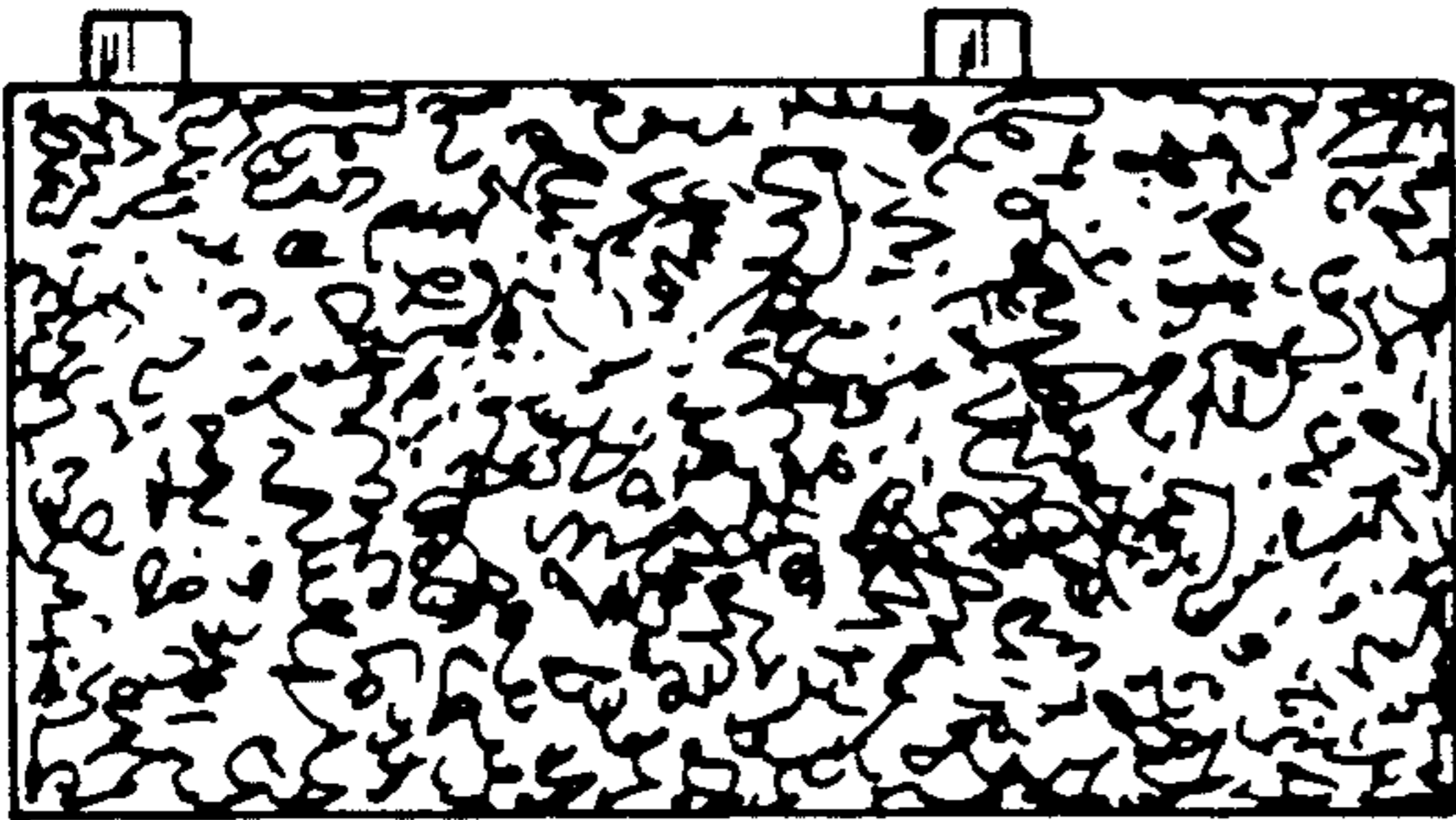

FIG-12

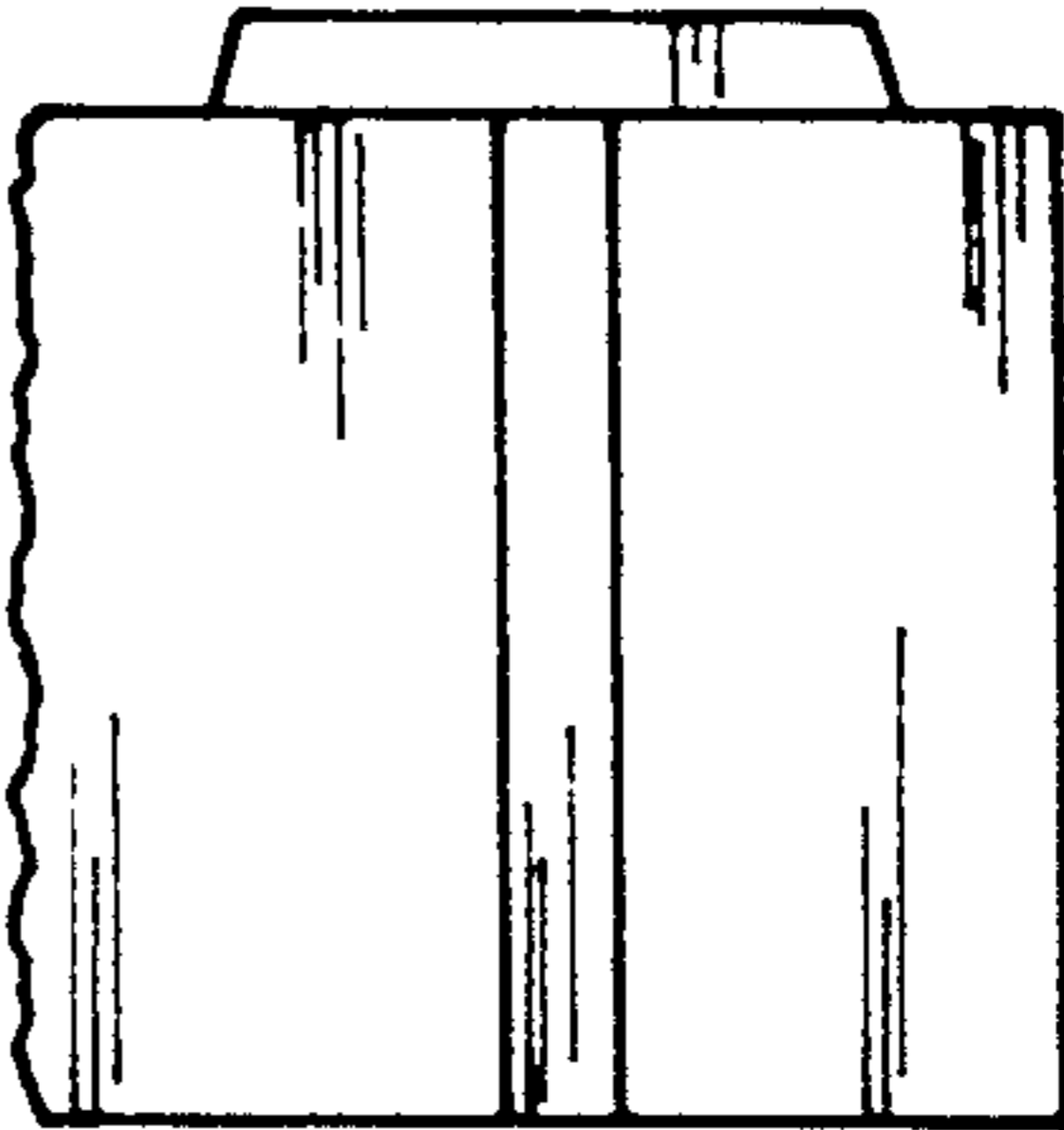

FIG-13

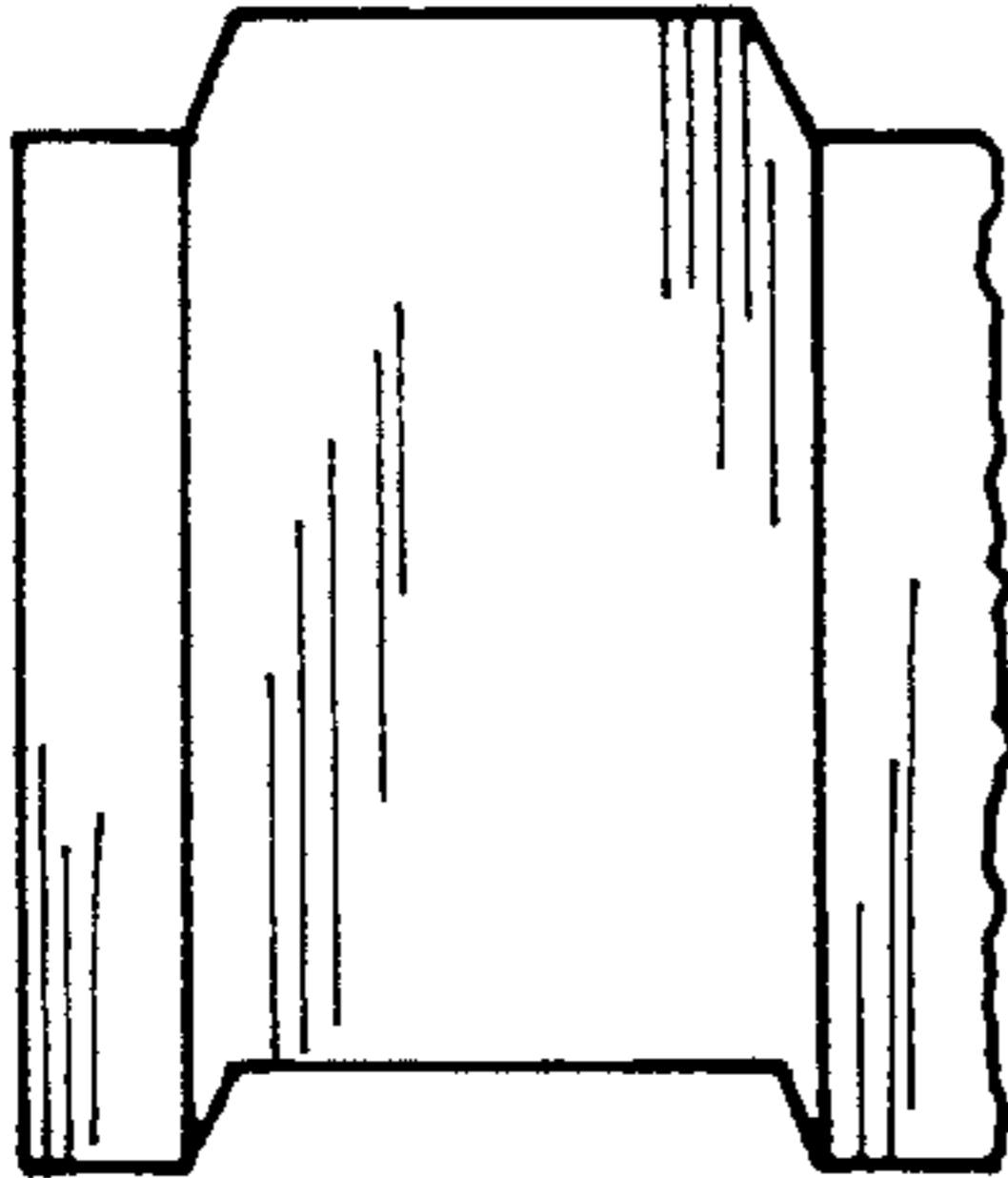

FIG-14

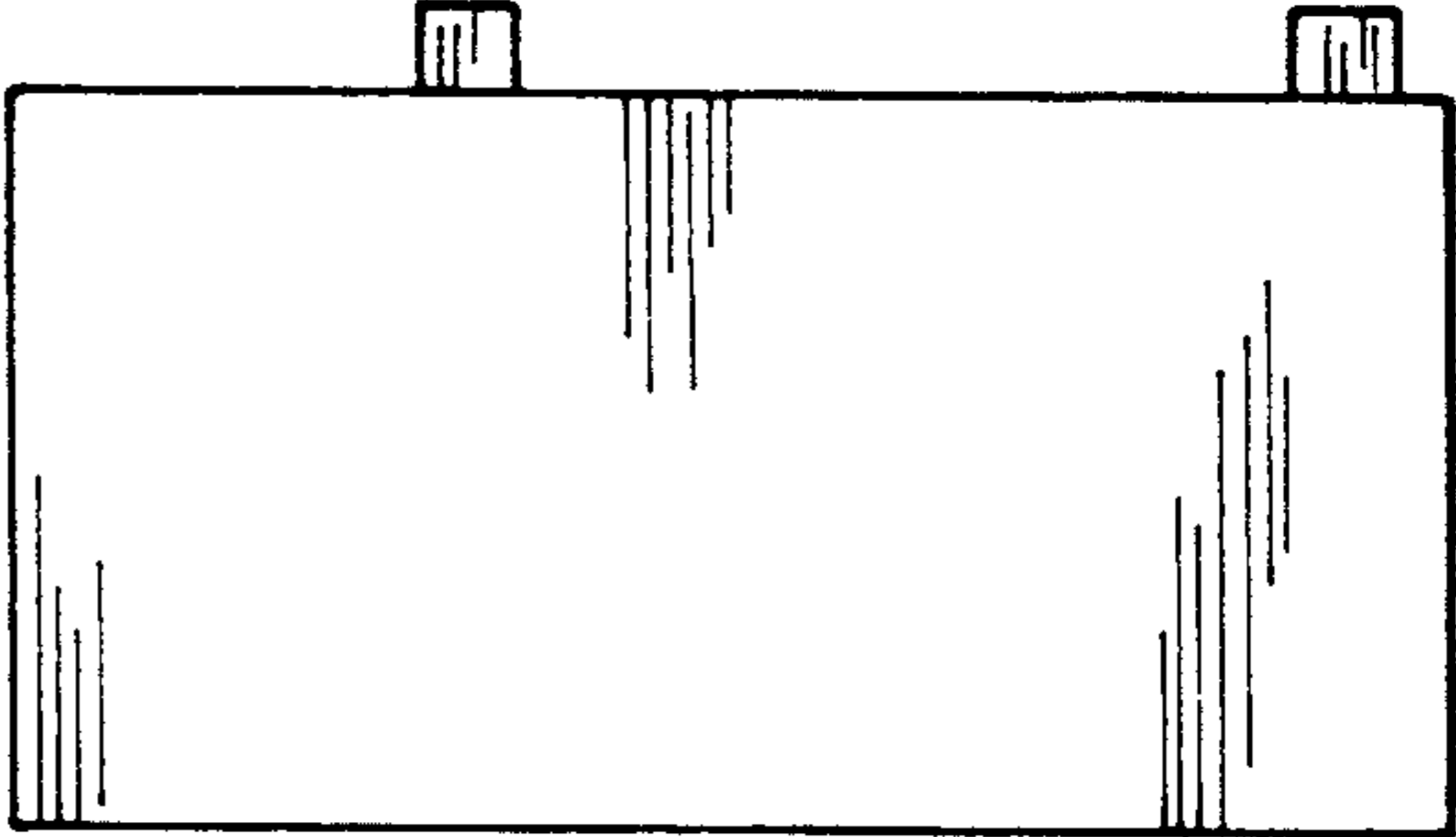

FIG-15

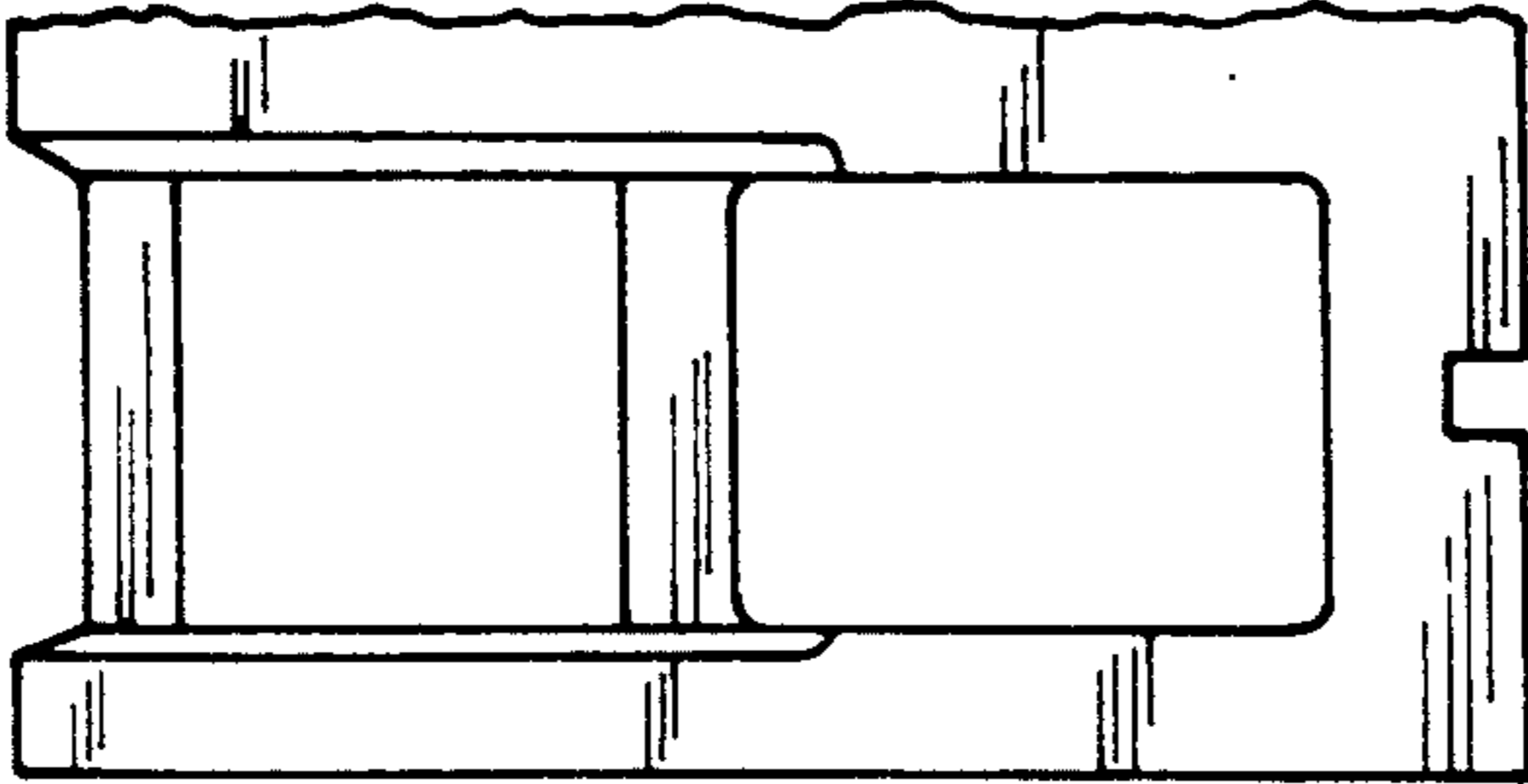

FIG-16