



US00D340966S

# United States Patent [19]

[11] Patent Number: **Des. 340,966**

Wagner

[45] Date of Patent: **\*\* Nov. 2, 1993**

[54] LAVATORY BOWL

D. 288,354 2/1987 Smith ..... D23/285

[75] Inventor: **Sherle Wagner, New York, N.Y.**

*Primary Examiner*—James R. Lergen

[73] Assignee: **Sherle Wagner International, Inc., New York, N.Y.**

*Attorney, Agent, or Firm*—Edgar A. Zarins; Malcolm L. Sutherland

[\*\*] Term: **14 Years**

### [57] CLAIM

[21] Appl. No.: **692,021**

The ornamental design for a lavatory bowl, as shown and described.

[22] Filed: **Apr. 26, 1991**

### DESCRIPTION

[52] U.S. Cl. .... **D23/285**

FIG. 1 is a top plan view of a lavatory bowl showing my new design;

[58] Field of Search ..... **D23/271-275, D23/284-294; 4/619, 630-636, 639, 640, 642, 650-660**

FIG. 2 is a front elevational view thereof;

FIG. 3 is a left side elevational view thereof, the right side being a mirror image of the left side;

FIG. 4 is a rear elevational view thereof;

FIG. 5 is a cross-sectional view taken along line 5—5 of FIG. 1;

FIG. 6 is a cross-sectional view taken along line 6—6 of FIG. 1;

FIG. 7 is a cross-sectional view taken along line 7—7 of FIG. 1;

FIG. 8 is a cross-sectional view taken along line 8—8 of FIG. 1; and,

FIG. 9 is a cross-sectional view taken along line 9—9 of FIG. 1.

### [56] References Cited

#### U.S. PATENT DOCUMENTS

D. 78,257	4/1929	Bonner, Jr. ....	D23/292 X
D. 213,558	3/1969	Colborn .....	D23/285
D. 216,310	12/1969	Fortuno .....	D23/285
D. 241,846	10/1976	Ribits et al. ....	D23/285
D. 242,859	12/1976	Gruber .....	D23/285
D. 243,325	2/1977	Krause et al. ....	D23/285
D. 260,551	9/1981	Tang .....	D23/294
D. 261,929	11/1981	Primault .....	D23/292
D. 288,353	2/1987	Smith .....	D33/285

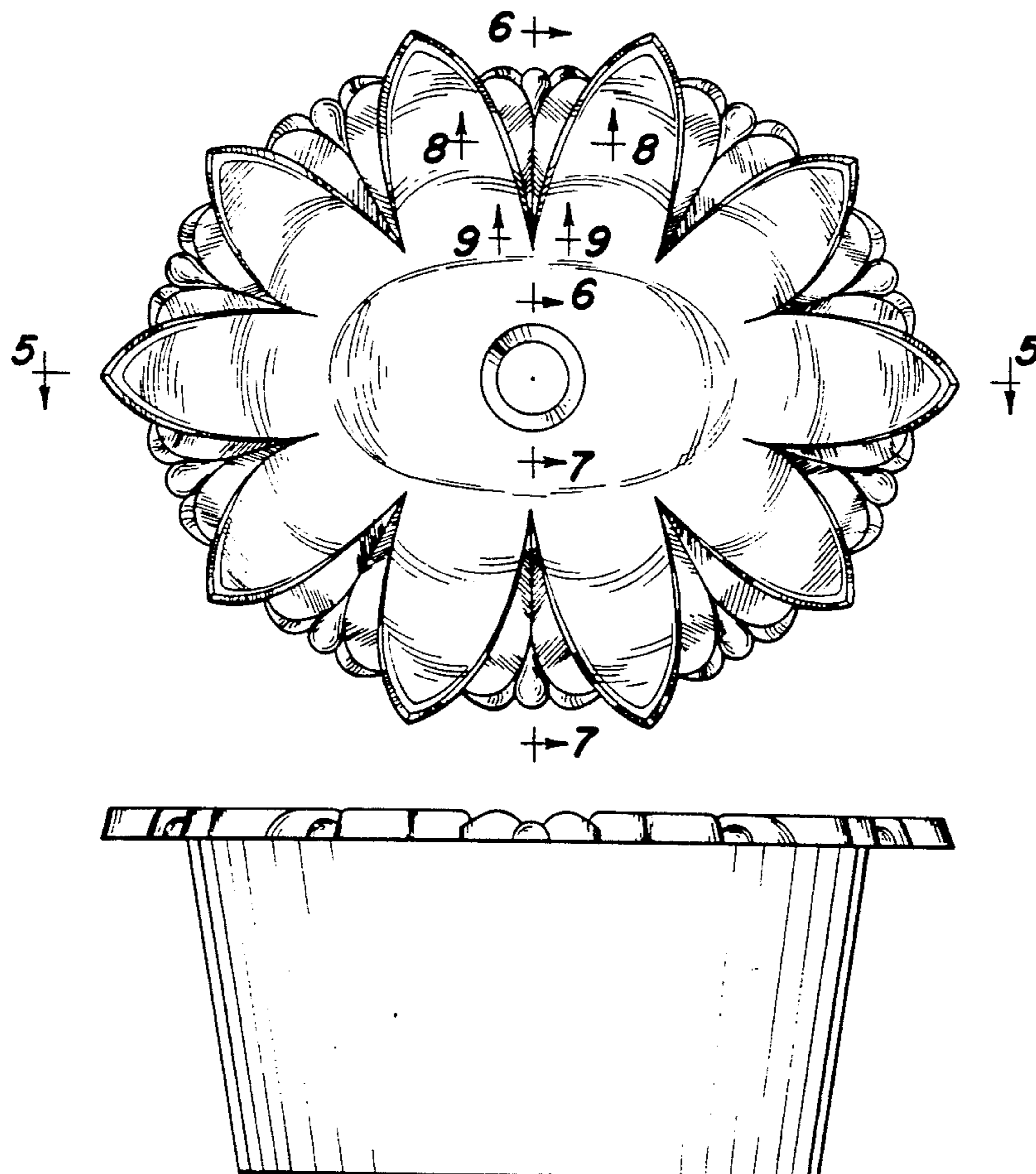

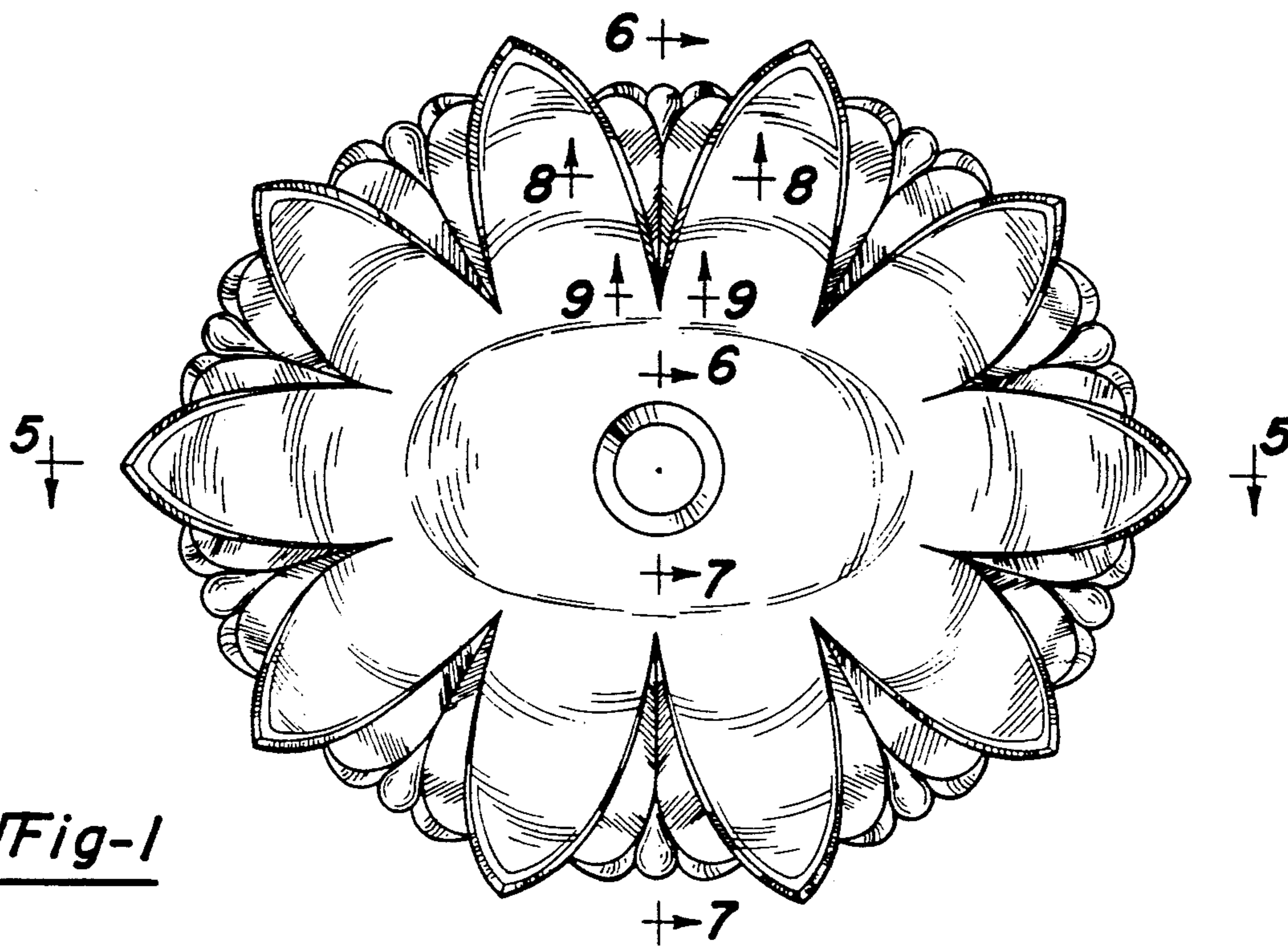

Fig-1

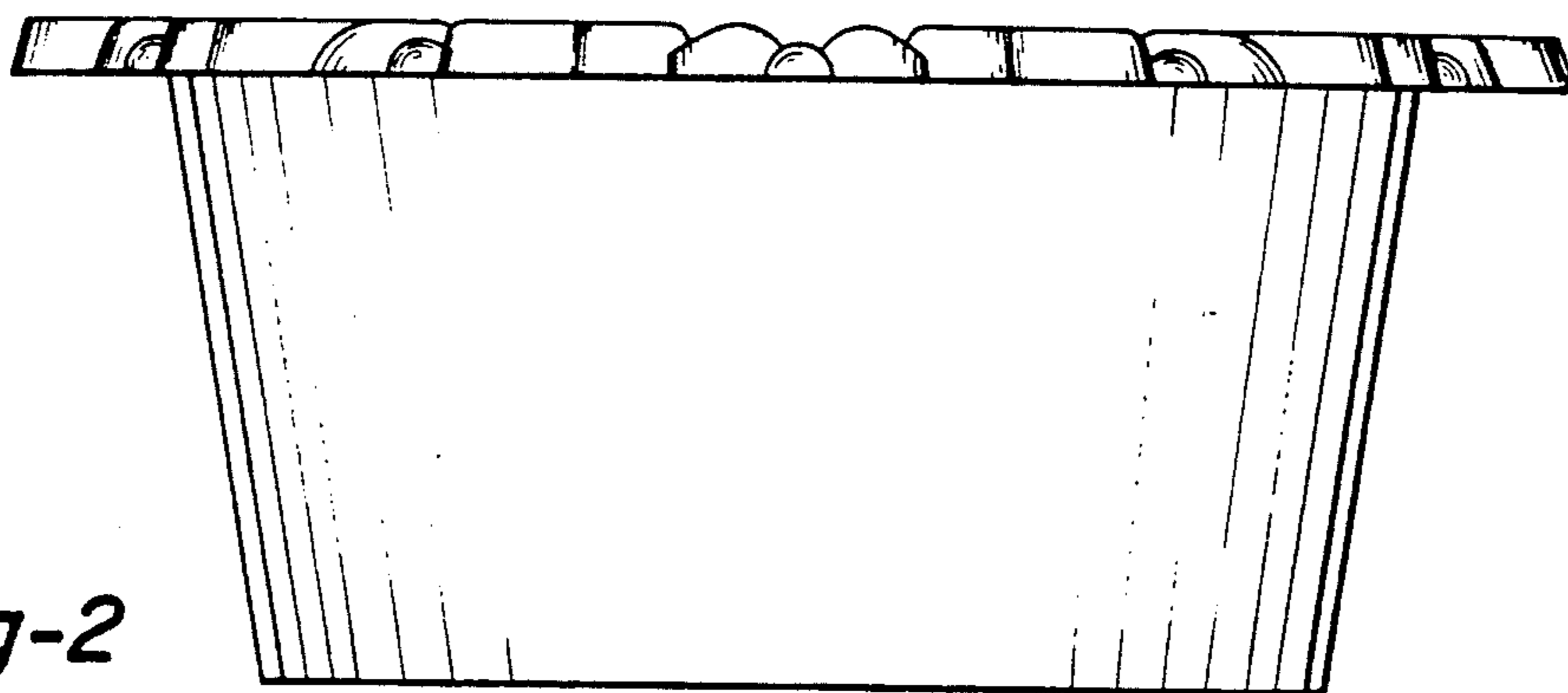

Fig-2

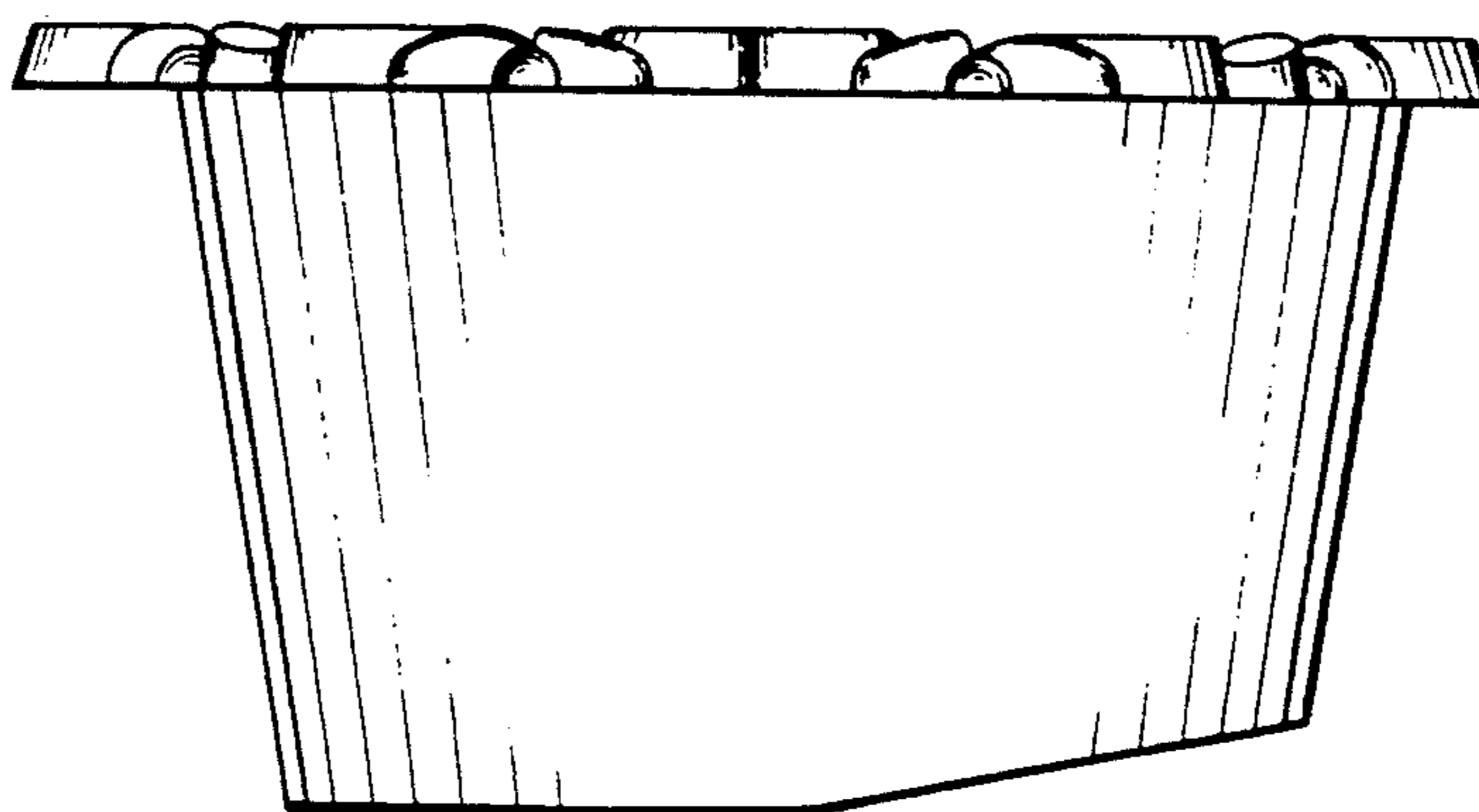

Fig-3

Fig-4

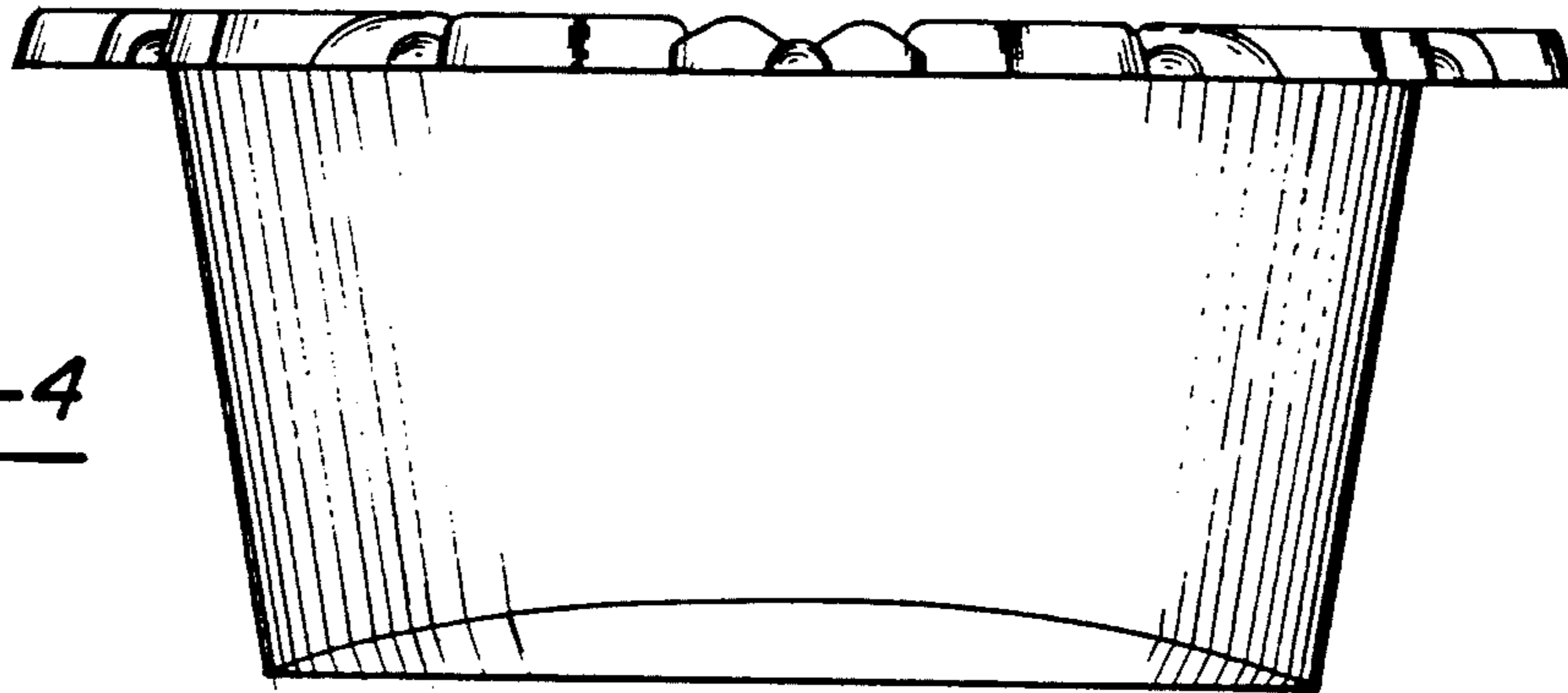

Fig-5

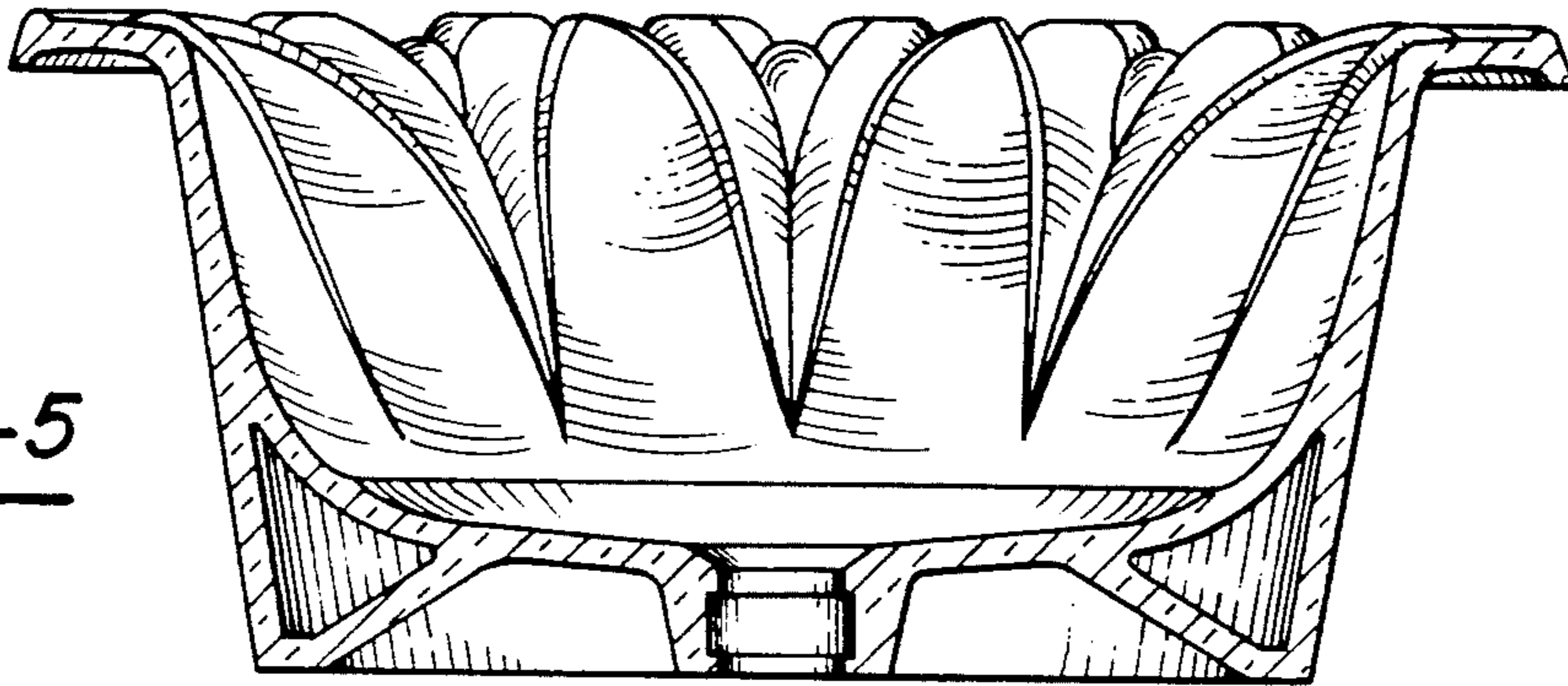

Fig-6

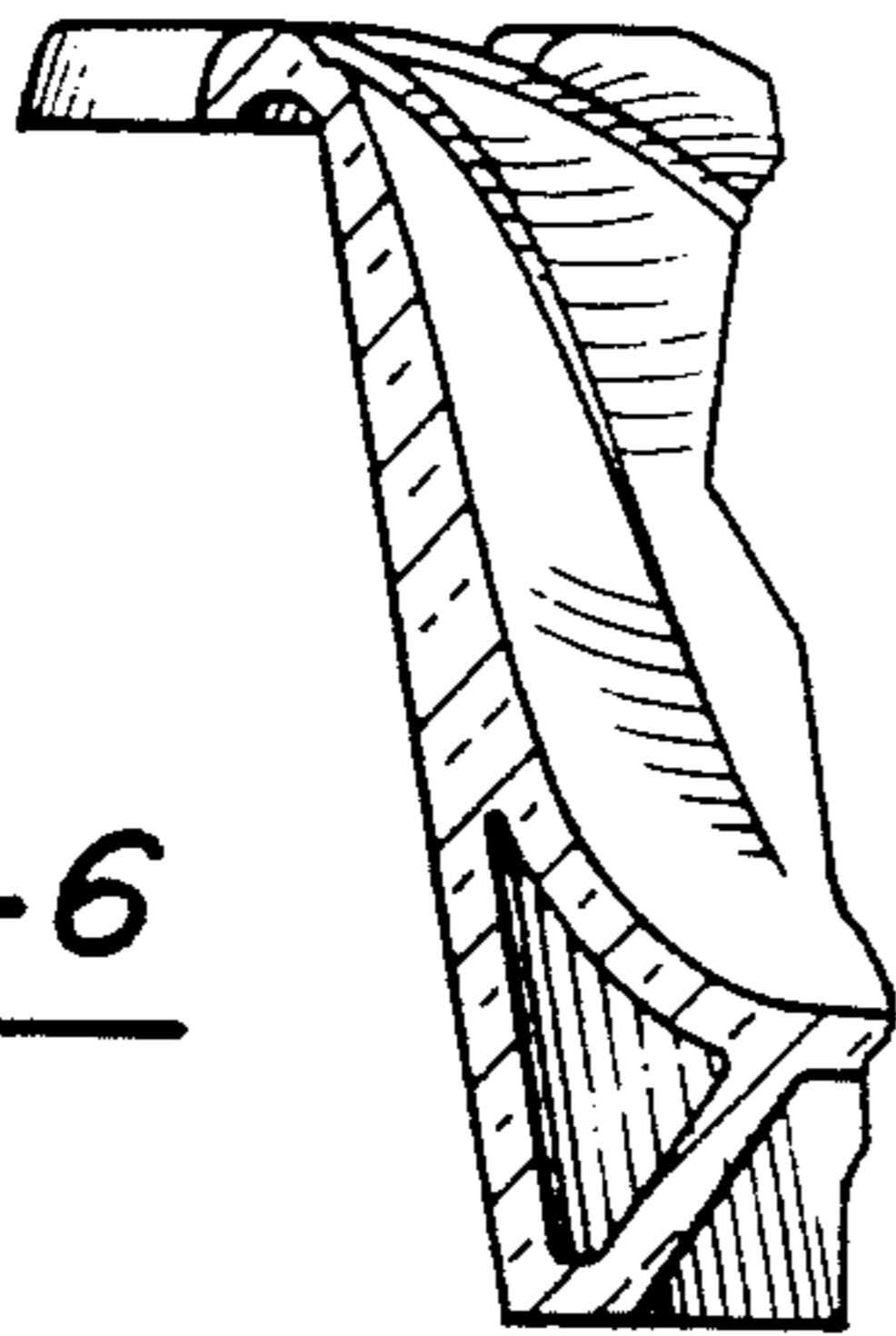

Fig-7

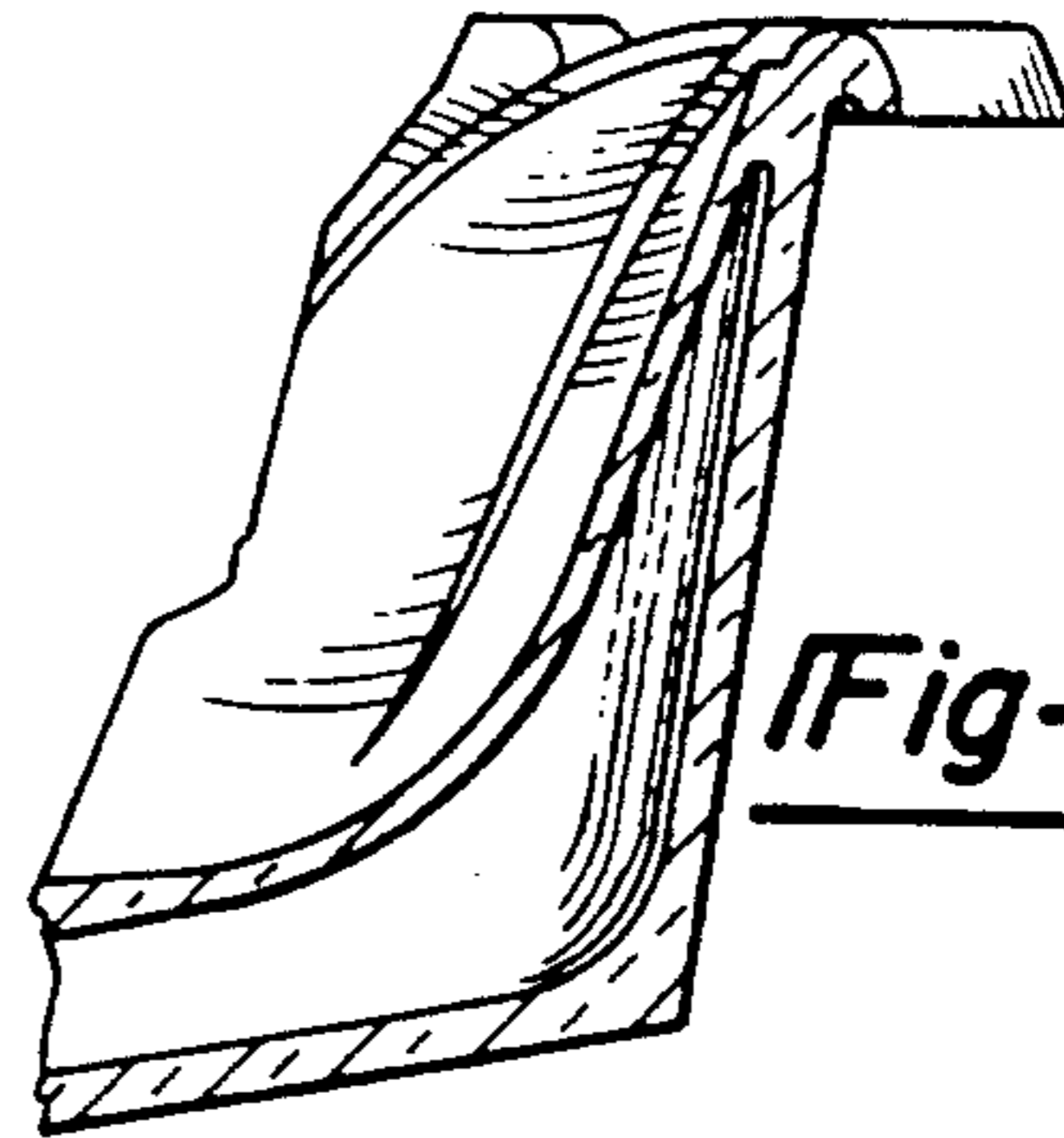

Fig-8



Fig-9

