



US00D340928S

United States Patent [19]

Knoedler et al.

[11] Patent Number: **Des. 340,928**

[45] Date of Patent: **** Nov. 2, 1993**

[54] **BABY MONITOR RECEIVER**

[75] Inventors: **Roy E. Knoedler; Ted F. Kelley**, both of Boulder; **Jack W. Renforth**, Aurora, all of Colo.

[73] Assignee: **Gerry Baby Products Company**, Denver, Colo.

[**] Term: **14 Years**

[21] Appl. No.: **753,696**

[22] Filed: **Sep. 3, 1991**

[52] U.S. Cl. **D14/159**

[58] Field of Search **D14/124, 137-139, D14/157, 159, 191, 218, 251, 257-258, 299; 455/73, 89, 90, 128**

[56] **References Cited**

U.S. PATENT DOCUMENTS

- D. 283,816 5/1986 Cutler D14/68
- D. 283,892 5/1986 Cutler D14/68
- D. 310,218 8/1990 Murphy D14/137
- D. 310,664 9/1990 Murphy D14/137

Primary Examiner—Terry A. Pfeffer
Attorney, Agent, or Firm—Biebel & French

[57] **CLAIM**

The ornamental design for a baby monitor receiver, as shown.

DESCRIPTION

FIG. 1 is a front, left side perspective view of the baby monitor receiver showing our new design;
 FIG. 2 is a top plan view thereof;
 FIG. 3 is a left side elevational view thereof;
 FIG. 4 is a right side elevational view thereof;
 FIG. 5 is a bottom plan view thereof;
 FIG. 6 is a rear elevational view thereof; and,
 FIG. 7 is a front elevational view thereof.

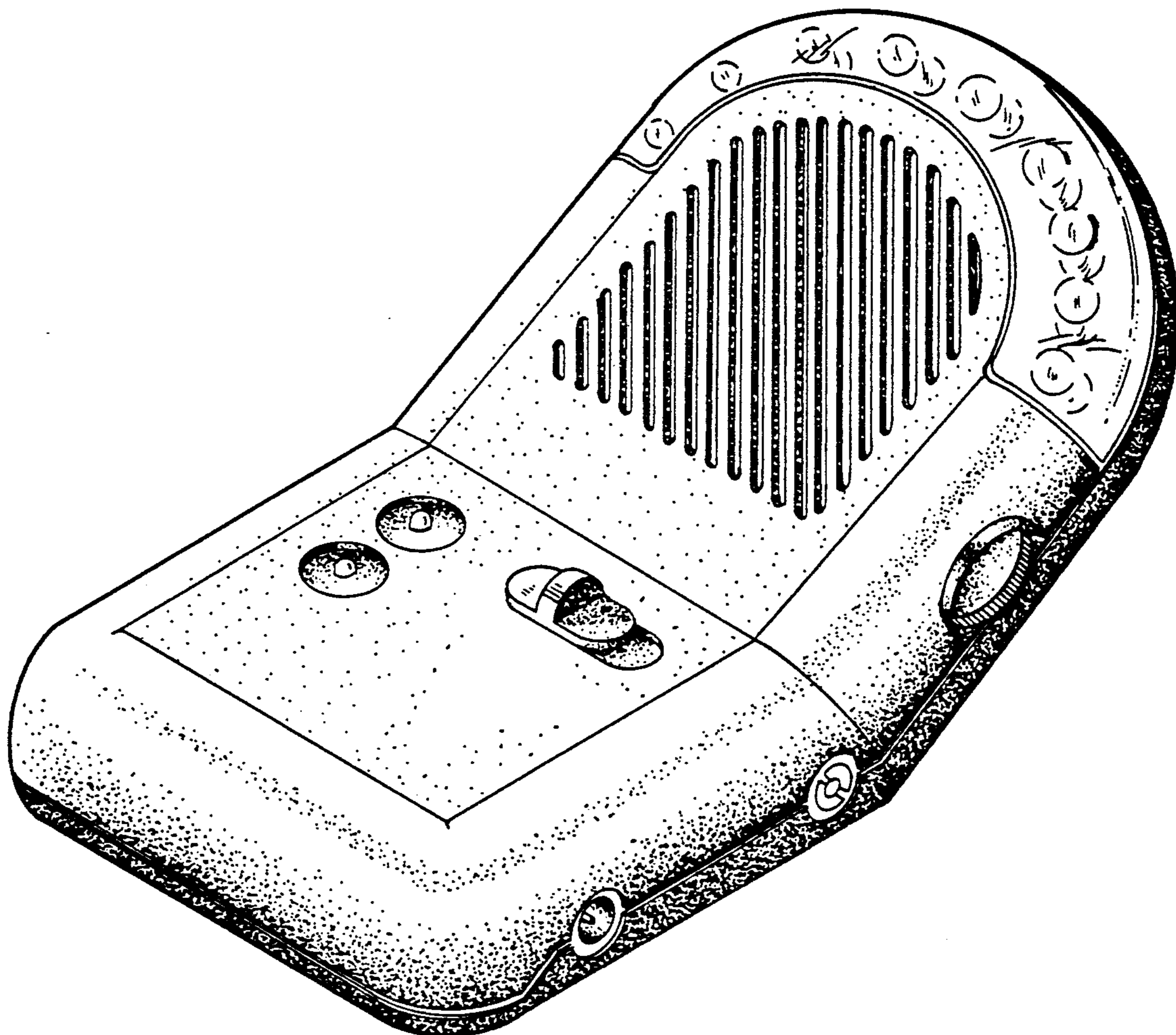

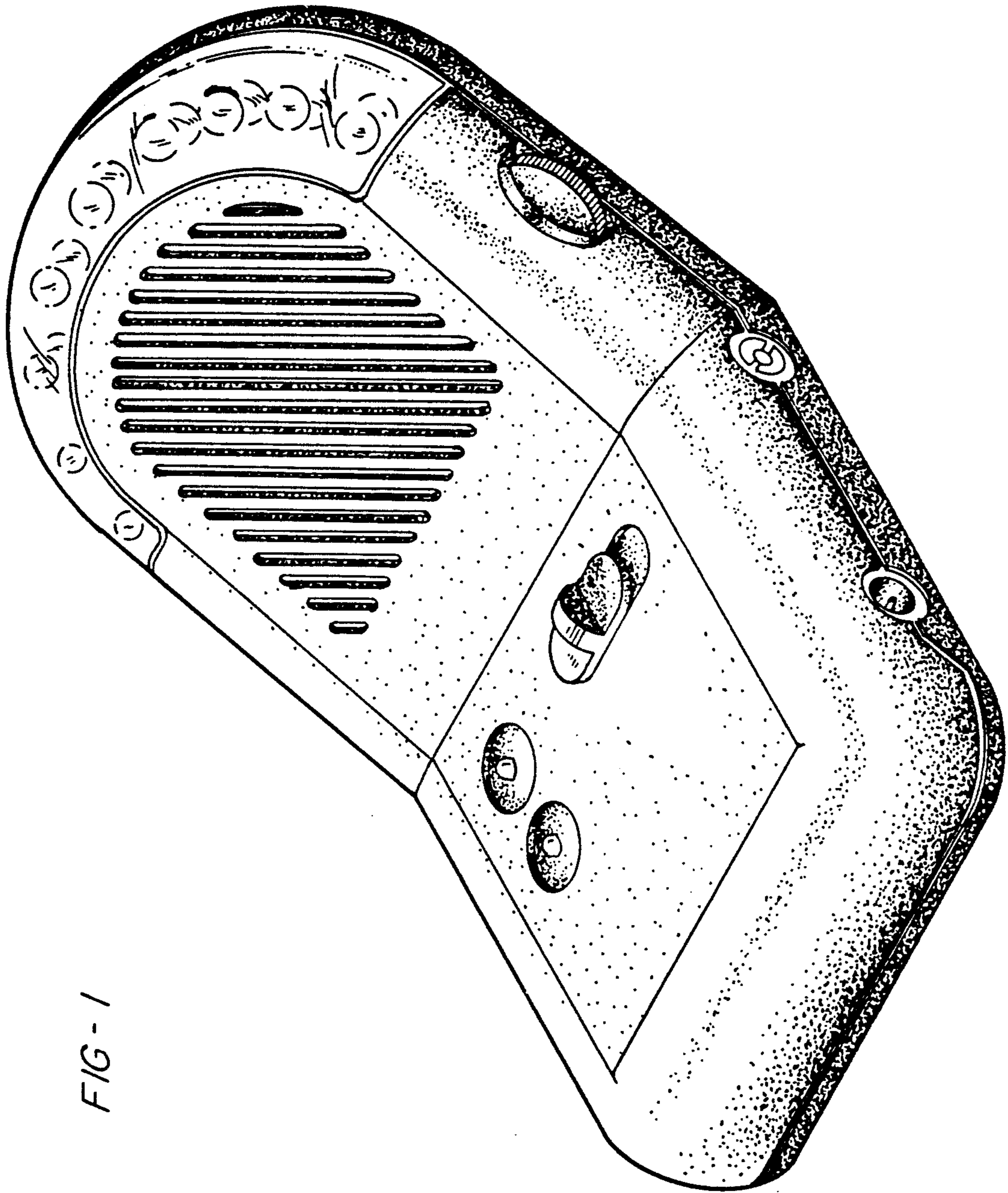
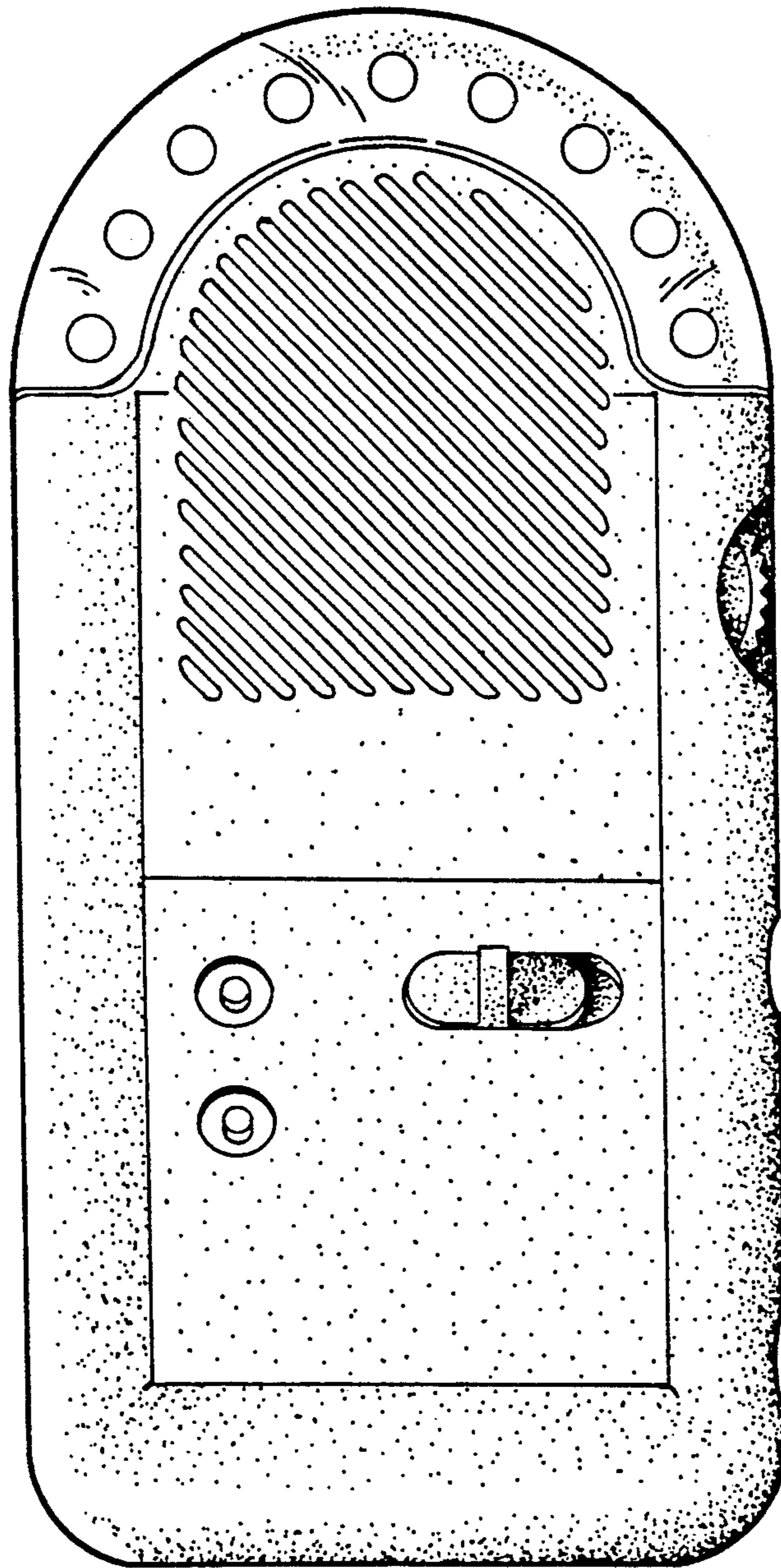

FIG-1

FIG - 2



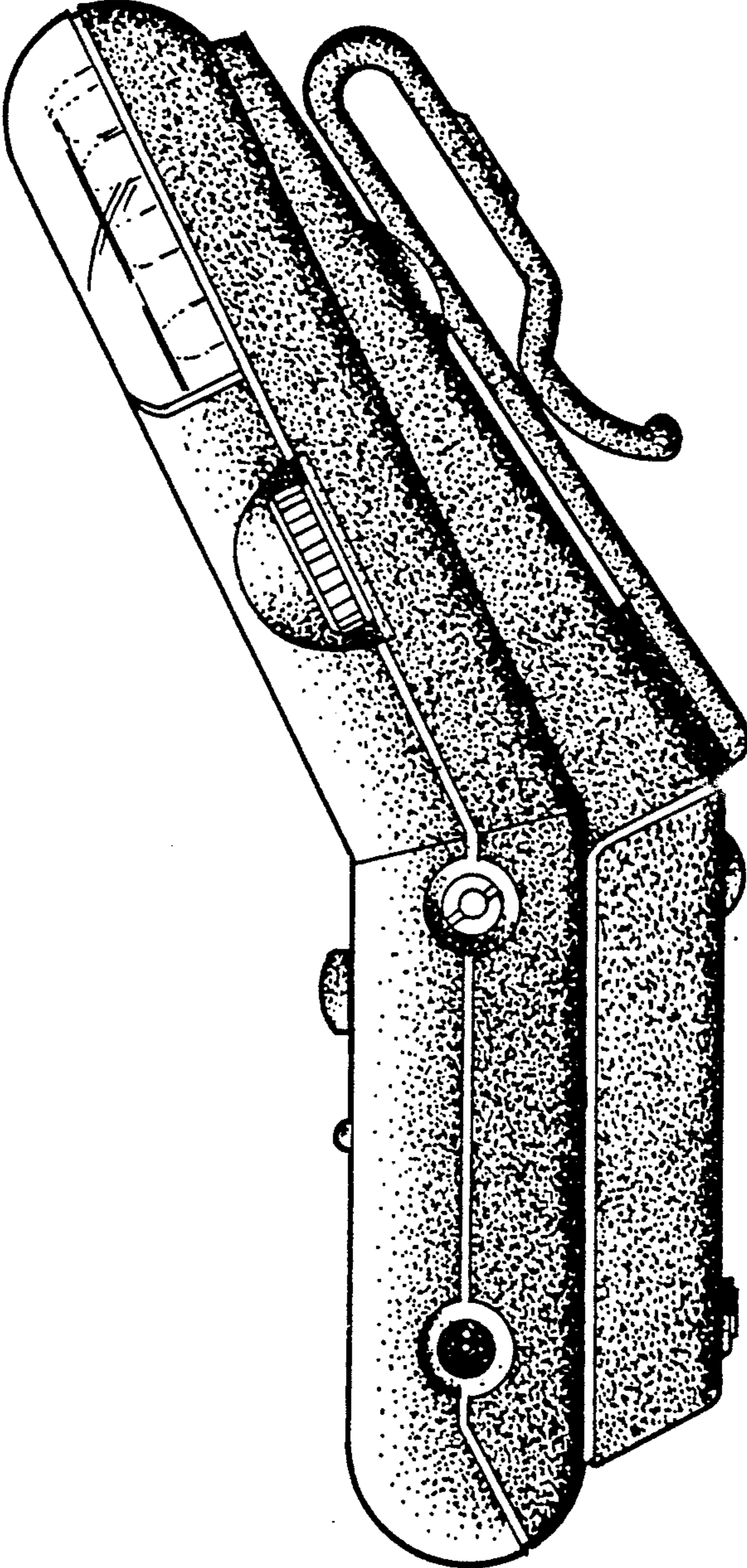

FIG - 3

FIG - 4

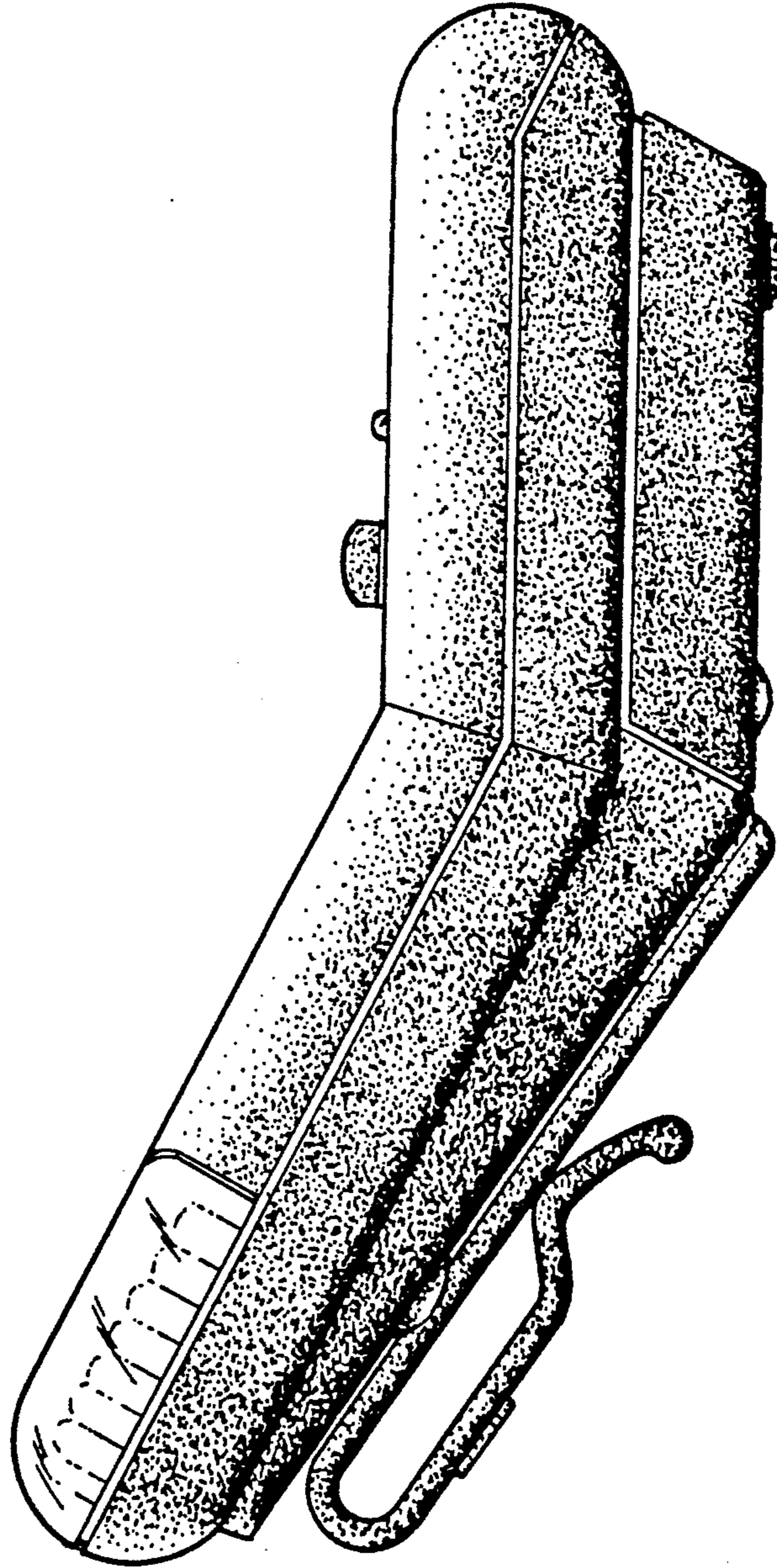

FIG - 5

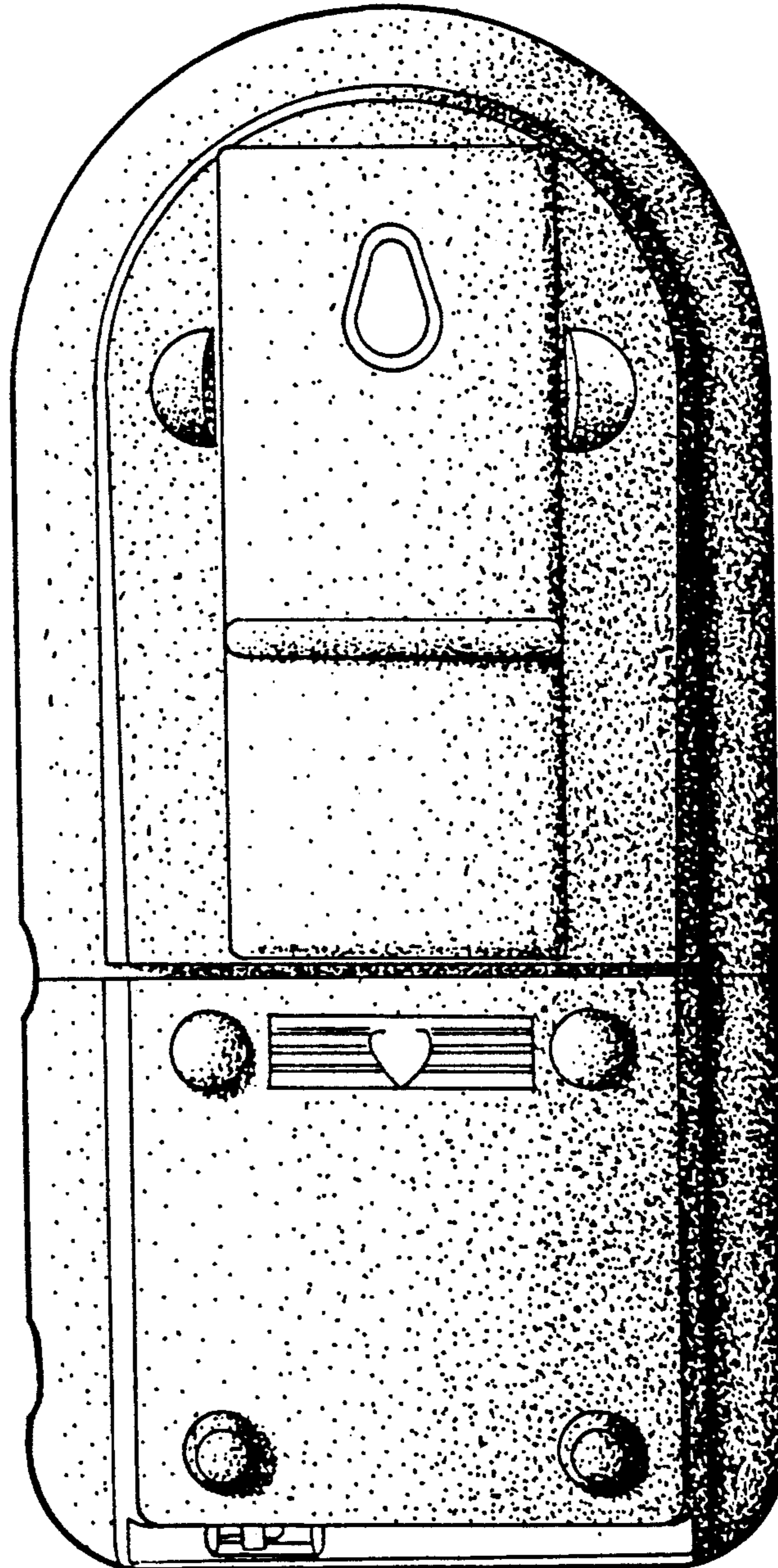

FIG - 6

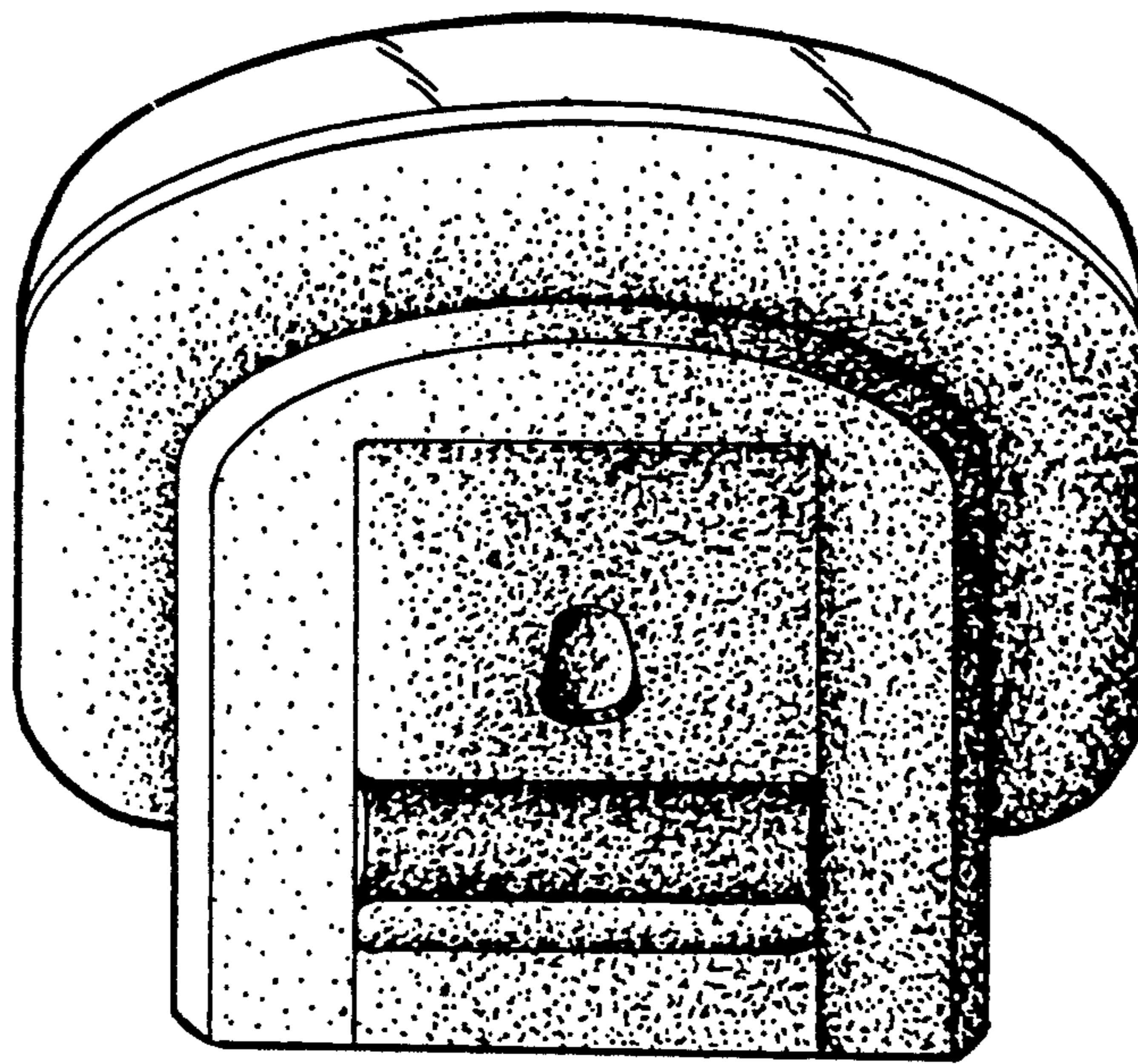

FIG - 7

