



US00D340850S

# United States Patent [19]

[11] Patent Number: **Des. 340,850**

**Tang**

[45] Date of Patent: **\*\* Nov. 2, 1993**

[54] **TAG ATTACHMENT APPARATUS**

[75] Inventor: **Kwok Y. Tang**, Tsuen Wan New Territories, Hong Kong

[73] Assignee: **Central Notion Co., Inc.**, Brooklyn, N.Y.

[\*\*] Term: **14 Years**

[21] Appl. No.: **818,962**

[22] Filed: **Jan. 10, 1992**

[52] U.S. Cl. .... **D8/68**

[58] Field of Search ..... **D8/61, 68; 140/123.6, 140/93.2, 152, 93.4**

[56] **References Cited**

**U.S. PATENT DOCUMENTS**

D. 273,171	3/1984	Bone	.....	D8/68
D. 297,399	8/1988	Furutsu	.....	D8/68
4,934,416	6/1990	Tonkiss	.....	140/93.2
5,137,060	8/1992	Wolcott	.....	140/123.6

*Primary Examiner*—Alan P. Douglas  
*Assistant Examiner*—J. H. Musgrove  
*Attorney, Agent, or Firm*—Malina & Wolson

[57] **CLAIM**

The ornamental design for a tag attachment apparatus, as shown and described.

**DESCRIPTION**

FIG. 1 is a front right perspective view of a tag attachment apparatus in accordance with my invention;  
FIG. 2 is a top plan view of the tag attachment apparatus;  
FIG. 3 is a front elevational view of the tag attachment apparatus in FIG. 1;  
FIG. 4 is a right and left side elevational view of the tag attachment apparatus;  
FIG. 5 is a rear elevational view of the tag attachment apparatus of FIG. 1; and,  
FIG. 6 is a bottom plan view of the tag attachment apparatus of FIG. 1.

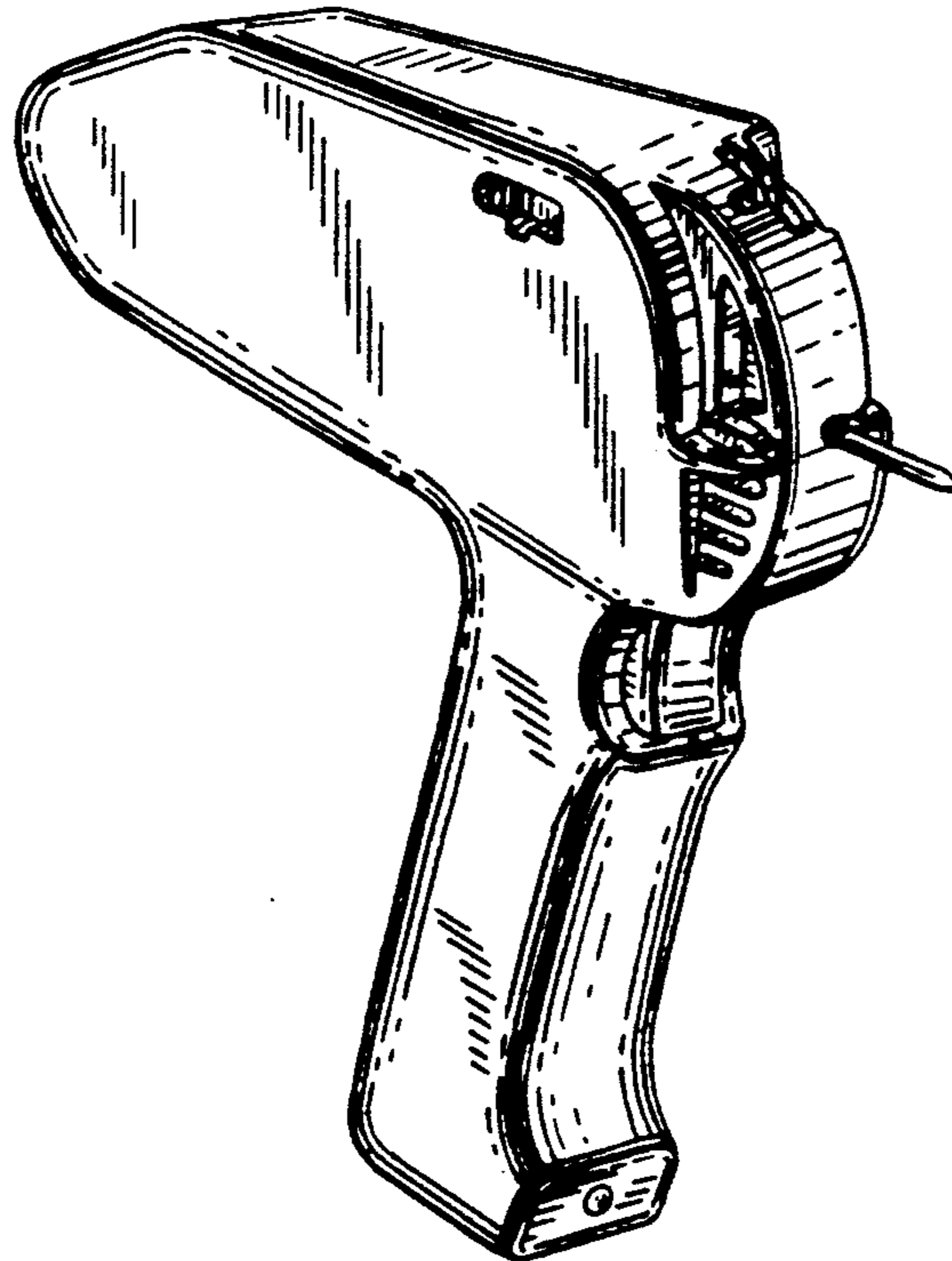

FIG. 1

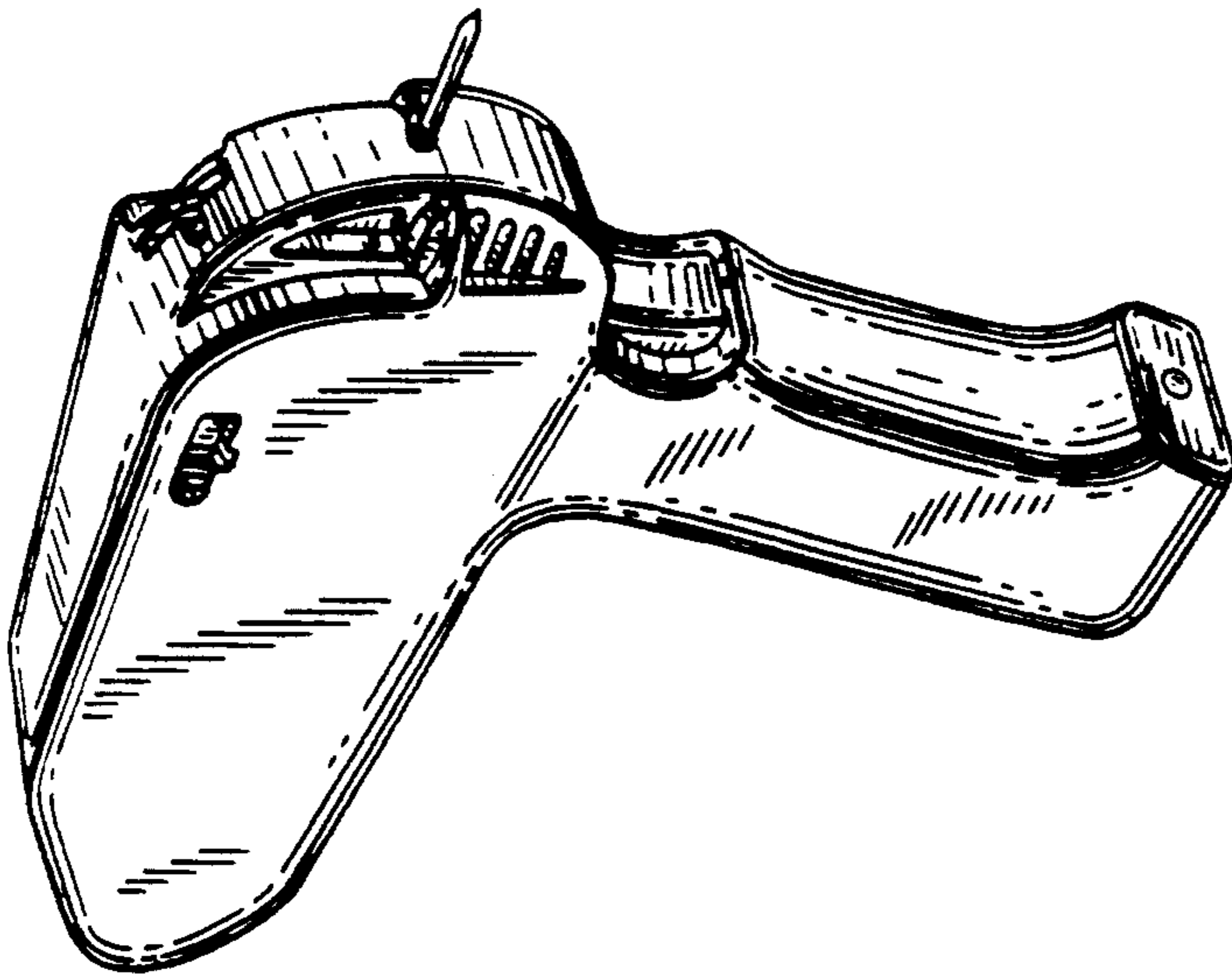
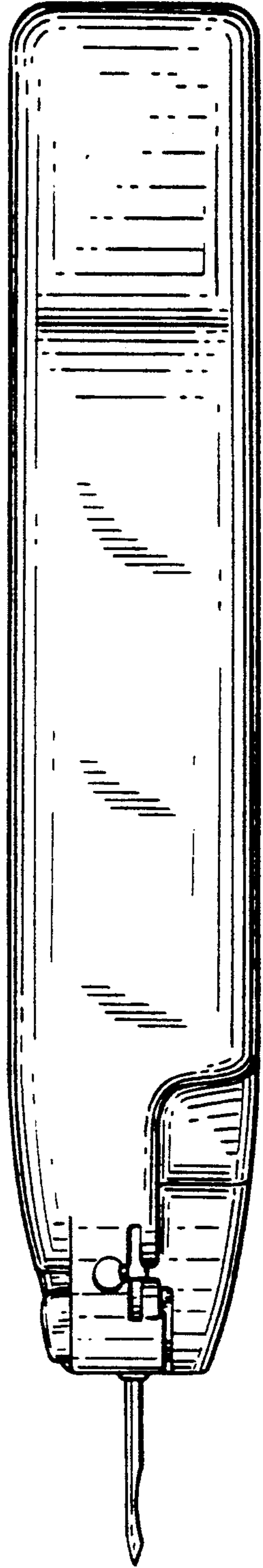

FIG. 2



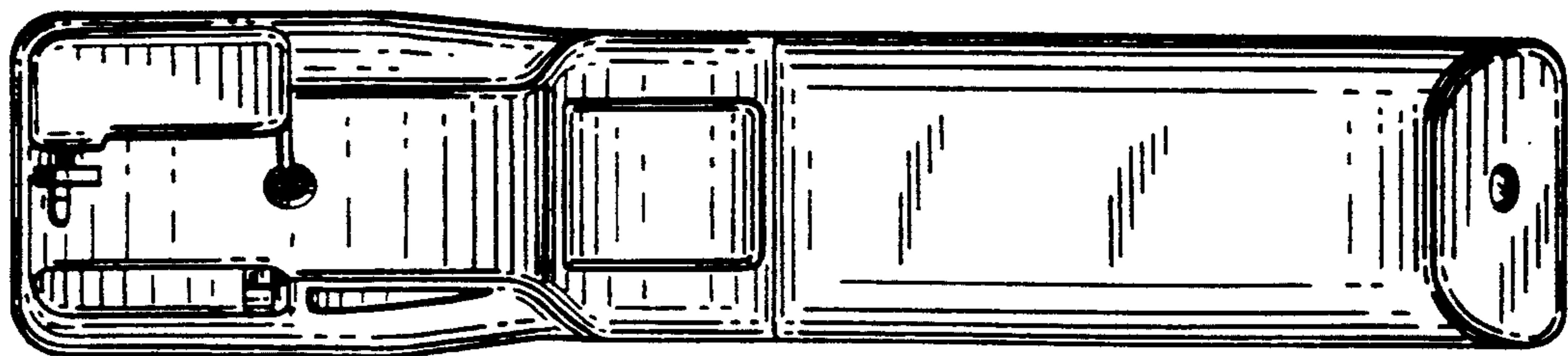
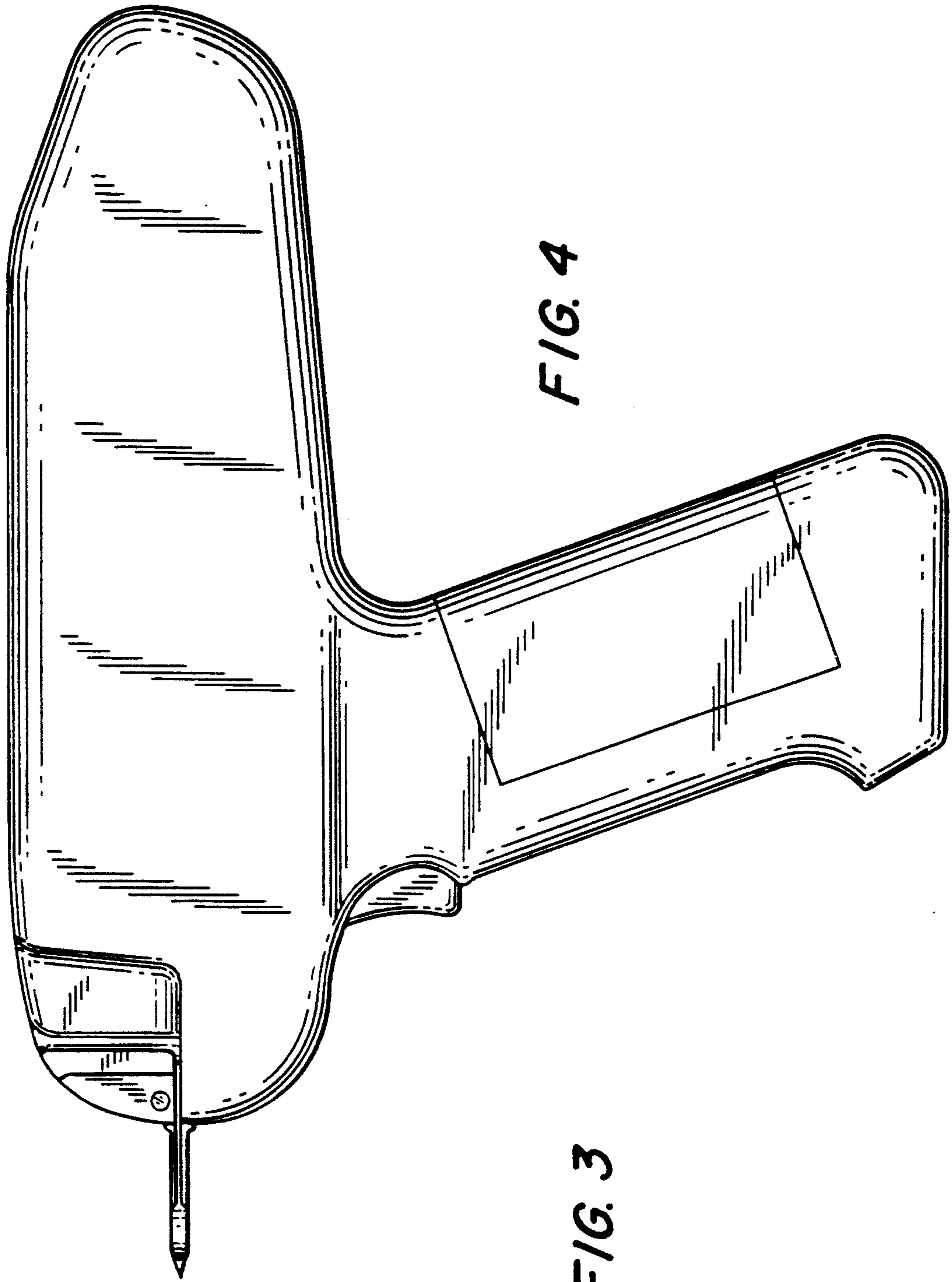

FIG. 5

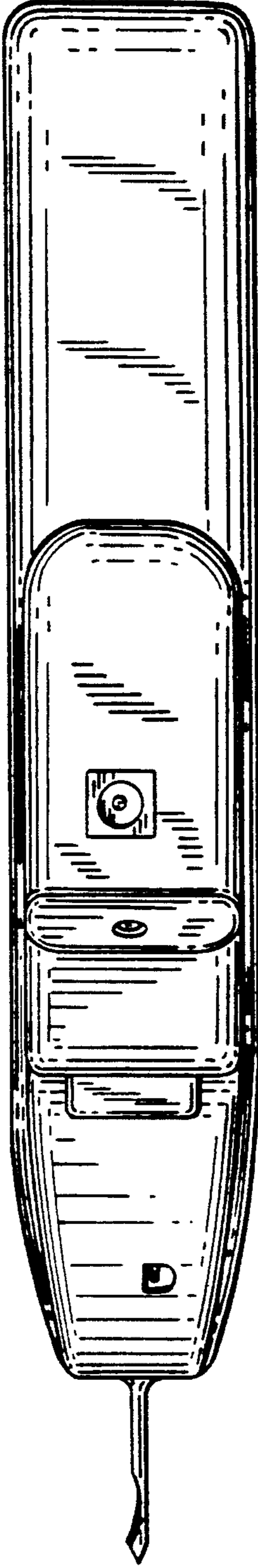
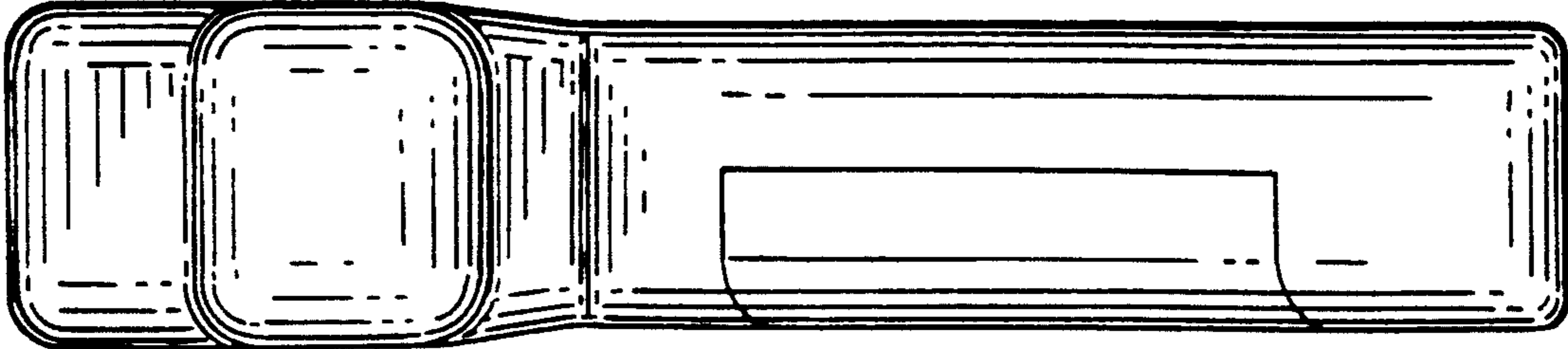

FIG. 6