



US00D340835S

# United States Patent [19]

[11] Patent Number: **Des. 340,835**

Lupa et al.

[45] Date of Patent: **\*\* Nov. 2, 1993**

[54] **BARBECUE GRILL**

[76] Inventors: **Mircea Lupa**, 14442 Fairview La.,  
Huntington Beach, Calif. 92647;  
**John Coroama**, 6691 Hazard Ave.,  
Westminster, Calif. 92683

[\*\*] Term: **14 Years**

[21] Appl. No.: **748,051**

[22] Filed: **Aug. 21, 1991**

[52] U.S. Cl. .... **D7/409; D7/402**

[58] Field of Search ..... **D7/402, 408, 409, 333-337,  
D7/323; D34/38; 99/419, 421 R, 421 H, 421  
HH, 422, 425, 426, 444, 445, 449; 126/9 R, 11,  
25 R, 27, 29, 30, 51, 214 C, 333, 337 R, 339**

[56] **References Cited**

**U.S. PATENT DOCUMENTS**

D. 243,144	1/1977	Jenn et al. ....	D7/337
D. 263,918	4/1982	Boyd .....	D7/336
525,723	9/1894	Schambrue .....	126/337 R X
1,435,938	11/1922	O'Dowd .....	D7/337 X
2,216,457	10/1940	Salisbury .....	126/30 X
2,511,515	6/1950	Schmitt .....	126/25 R X
3,027,887	4/1962	Krohncke .....	126/25 R
3,092,015	6/1963	Tucker et al. ....	99/446
3,308,747	3/1967	Spagnolo .....	99/446
3,443,510	5/1969	Norton .....	99/446
3,552,301	1/1971	McNeff .....	99/446 X
3,853,046	12/1974	Pretorius .....	99/446 X
3,989,028	11/1976	Berger .....	99/446 X
4,493,308	1/1985	Hurley et al. ....	99/445 X
4,597,339	7/1986	McCaffrey et al. ....	D34/38 X
4,598,634	7/1986	Van Horn .....	99/446 X
4,608,917	9/1986	Faaborg .....	99/446 X
4,628,896	12/1986	Baynes .....	126/333 X
4,784,109	11/1988	Korpan .....	126/25 R

*Primary Examiner*—Alan P. Douglas  
*Assistant Examiner*—Caron D. Veynar  
*Attorney, Agent, or Firm*—Knobbe, Martens, Olson &  
Bear

[57] **CLAIM**

The ornamental design for a barbecue grill, as shown  
and described.

**DESCRIPTION**

FIG. 1 is a rear perspective view of the upper grill half

of a barbecue grill showing my new design, the upper  
barbecue grill shown separately for ease of illustration;  
FIG. 2 is a right side elevational view of the upper grill  
half of FIG. 1;  
FIG. 3 is a rear plan view of the upper grill half of FIG.  
1;  
FIG. 4 is a top plan view of the upper grill half of FIG.  
1;  
FIG. 5 is a front perspective view of the upper grill half  
of FIG. 1;  
FIG. 6 is a bottom plan view of the upper grill half of  
FIG. 1;  
FIG. 7 is a left side view of the upper grill half of FIG.  
1;  
FIG. 8 is a partial cross section view of the upper grill  
half of FIG. 1 taken along line 8—8 in FIG. 4;  
FIG. 9 is a front perspective view of the lower grill half  
shown separately for ease of illustration;  
FIG. 10 is a right side elevational view of the lower grill  
half of FIG. 9;  
FIG. 11 is a rear elevational view of the lower grill half  
of FIG. 9;  
FIG. 12 is a top plan view of the lower grill half of FIG.  
9;  
FIG. 13 is a front elevational view of the lower grill half  
of FIG. 9;  
FIG. 14 is a bottom plan view of the lower grill half of  
FIG. 9;  
FIG. 15 is a left side elevational view of the lower grill  
half of FIG. 9;  
FIG. 16 is a partial cross section view of the lower grill  
half of FIG. 9 taken along line 16—16 of FIG. 12;  
FIG. 17 is a top plan view of the assembled barbecue  
grill;  
FIG. 18 is a bottom plan view of the assembled barbe-  
cue grill of FIG. 17;  
FIG. 19 is a left side elevational view of the assembled  
barbecue grill of FIG. 17;  
FIG. 20 is a right side elevational view of the assembled  
barbecue grill of FIG. 17;  
FIG. 21 is a rear elevational view of the assembled  
barbecue grill of FIG. 17;  
FIG. 22 is a front elevational view of the assembled  
barbecue grill of FIG. 17; and,  
FIG. 23 is a partial cross section view of the assembled  
barbecue grill of FIG. 17 taken along line 23—23 of  
FIG. 17.

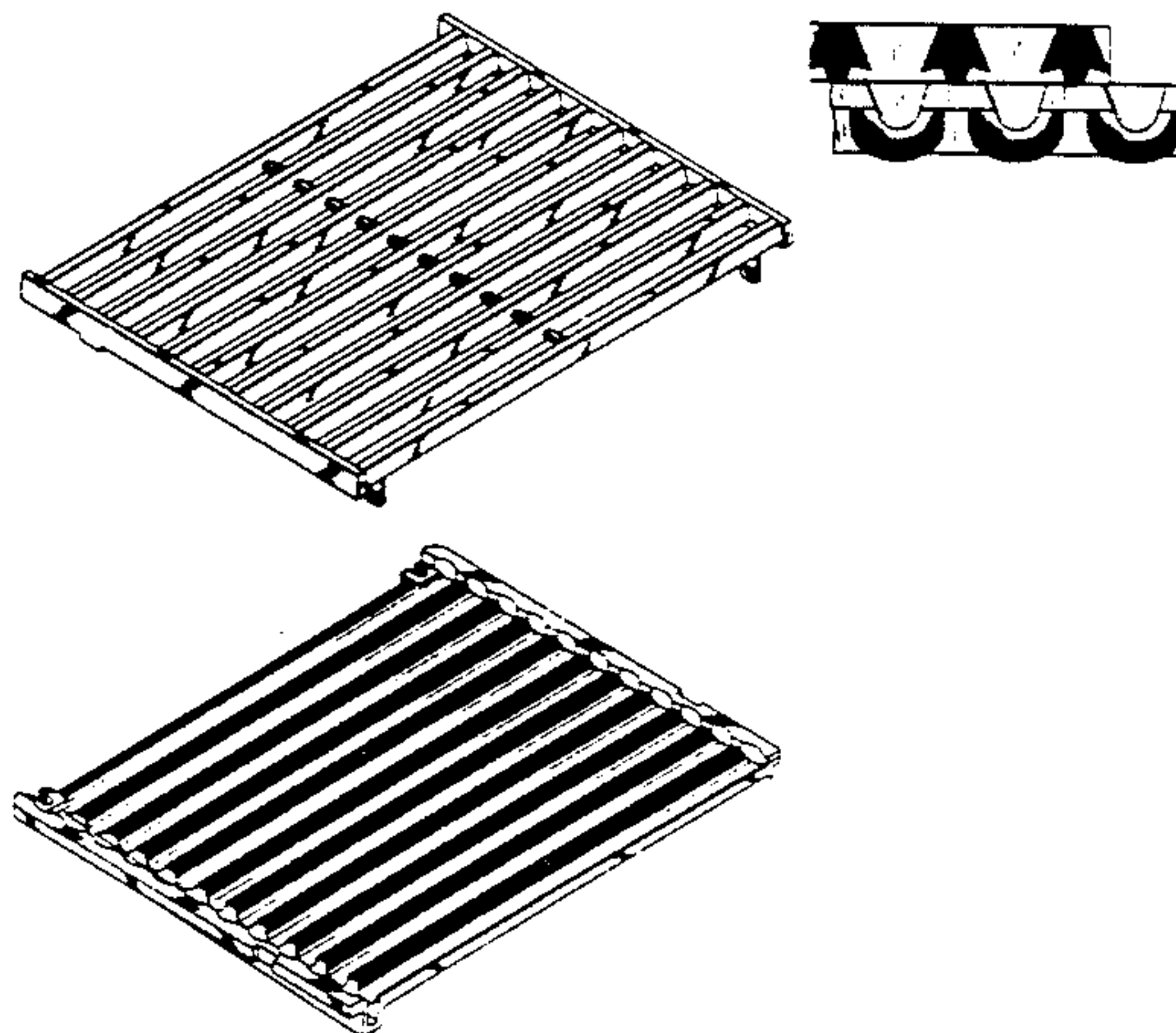



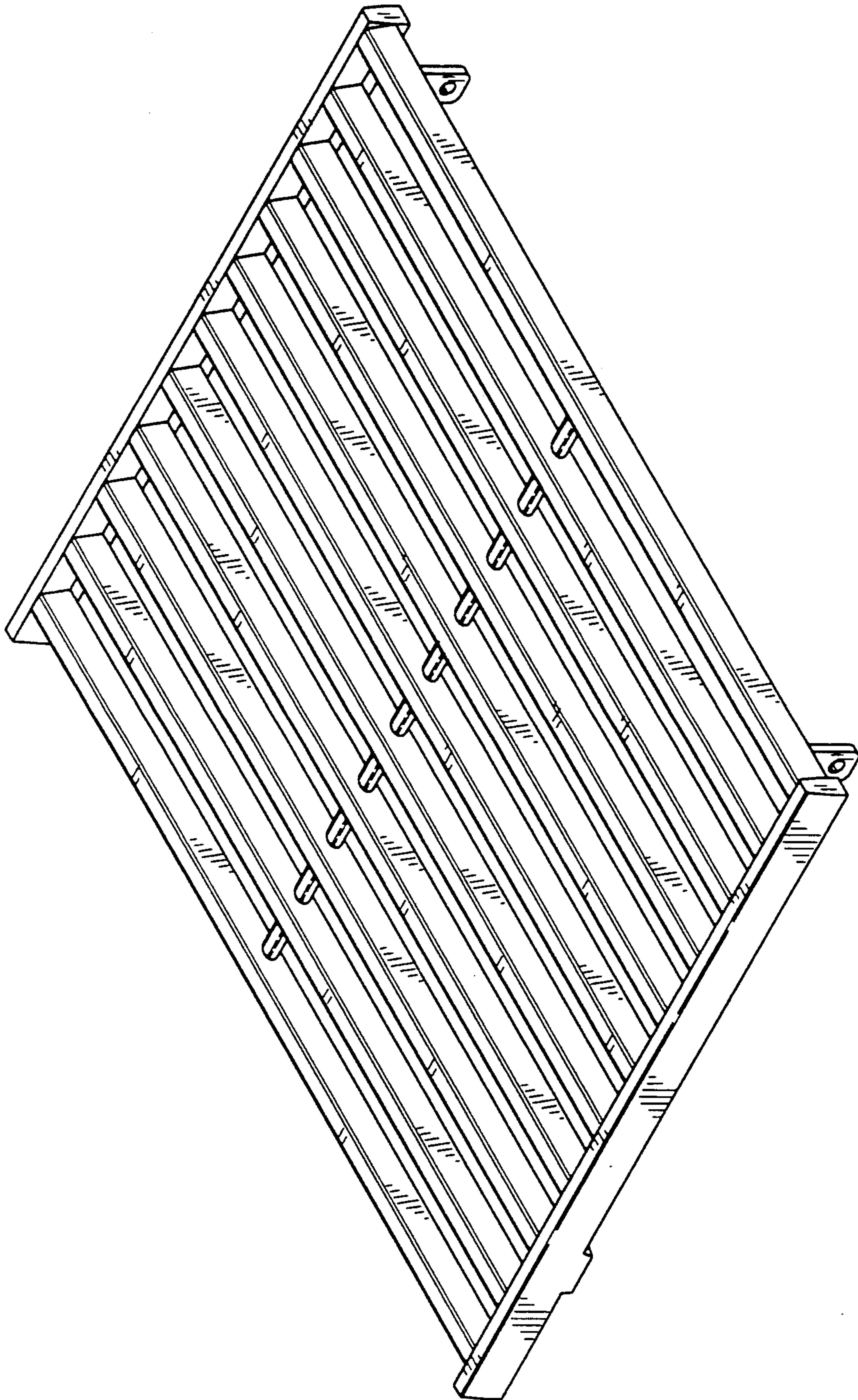

FIG. 1

FIG. 2



FIG. 3

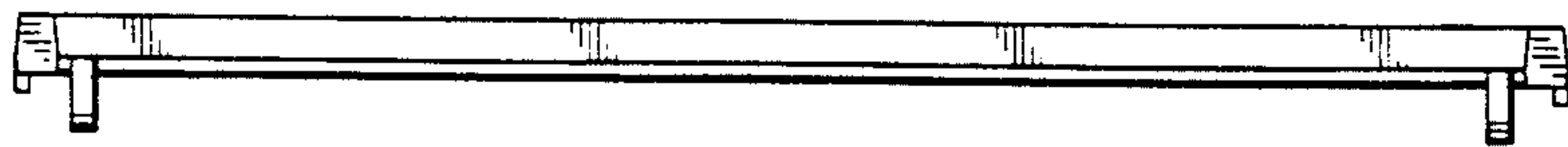

FIG. 4

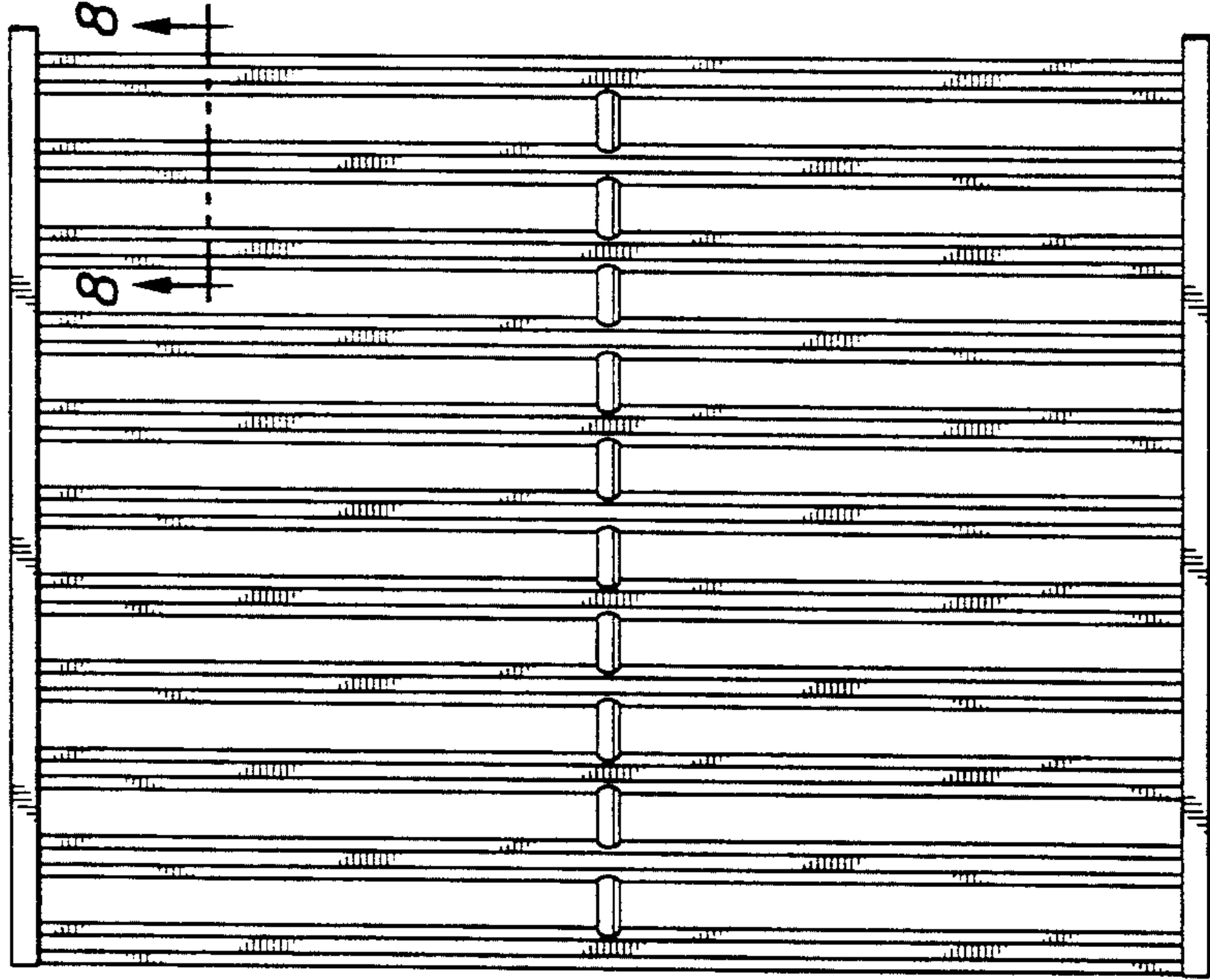

FIG. 5

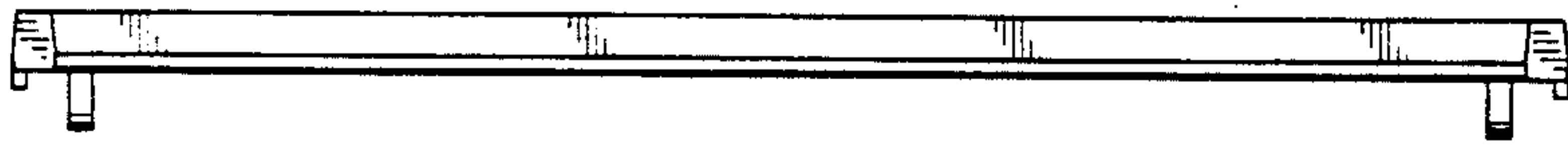

FIG. 8



FIG. 6

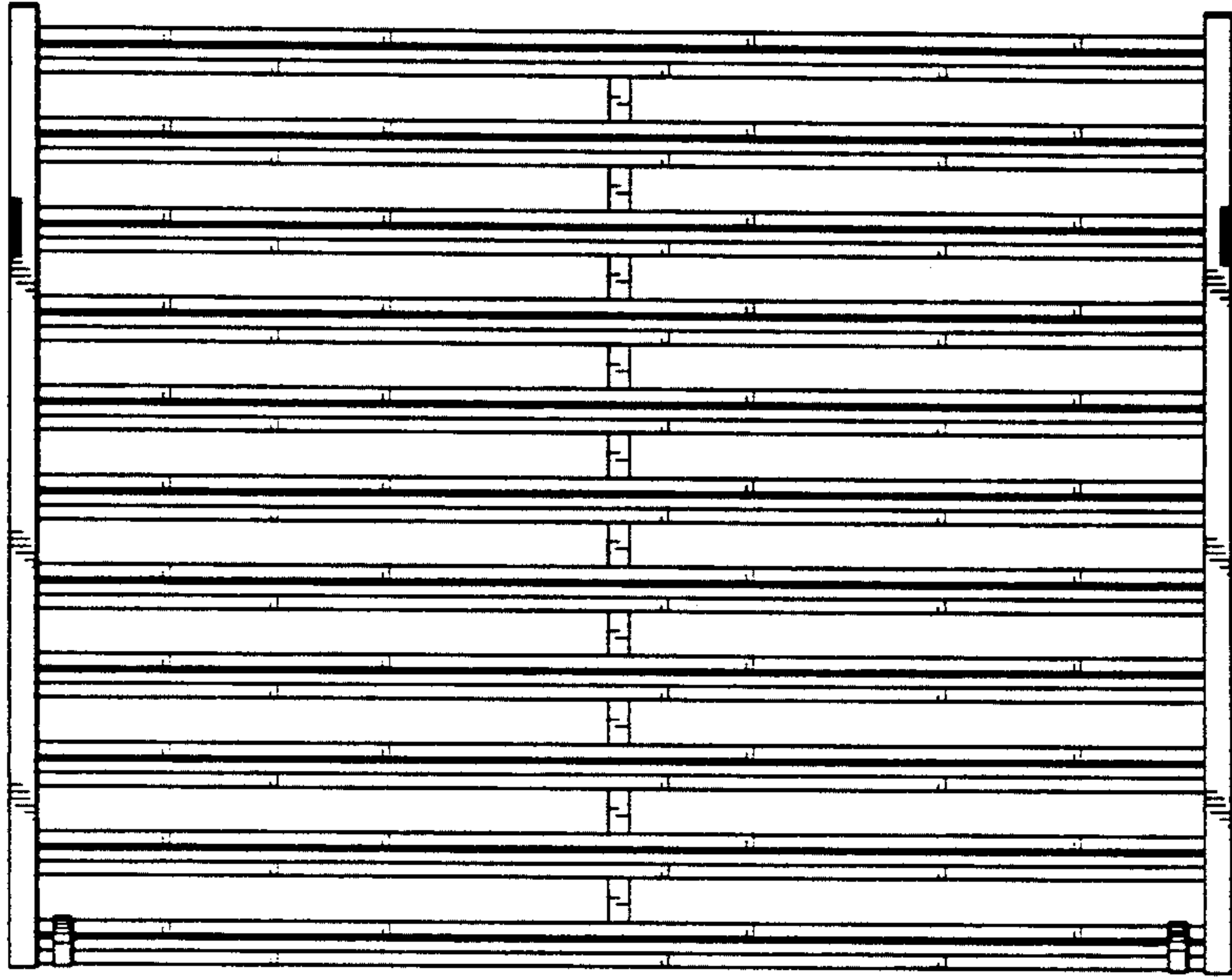
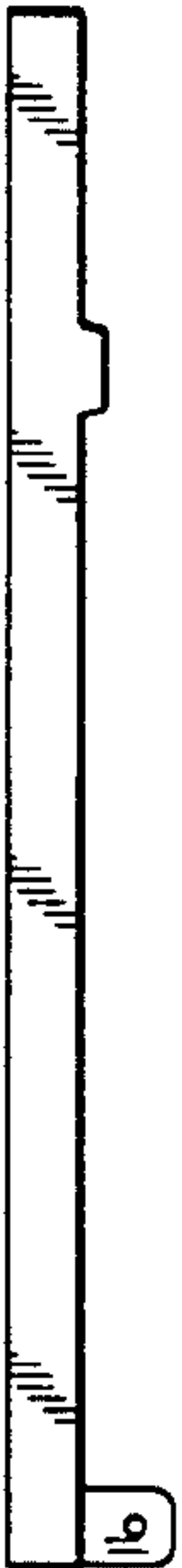

FIG. 7





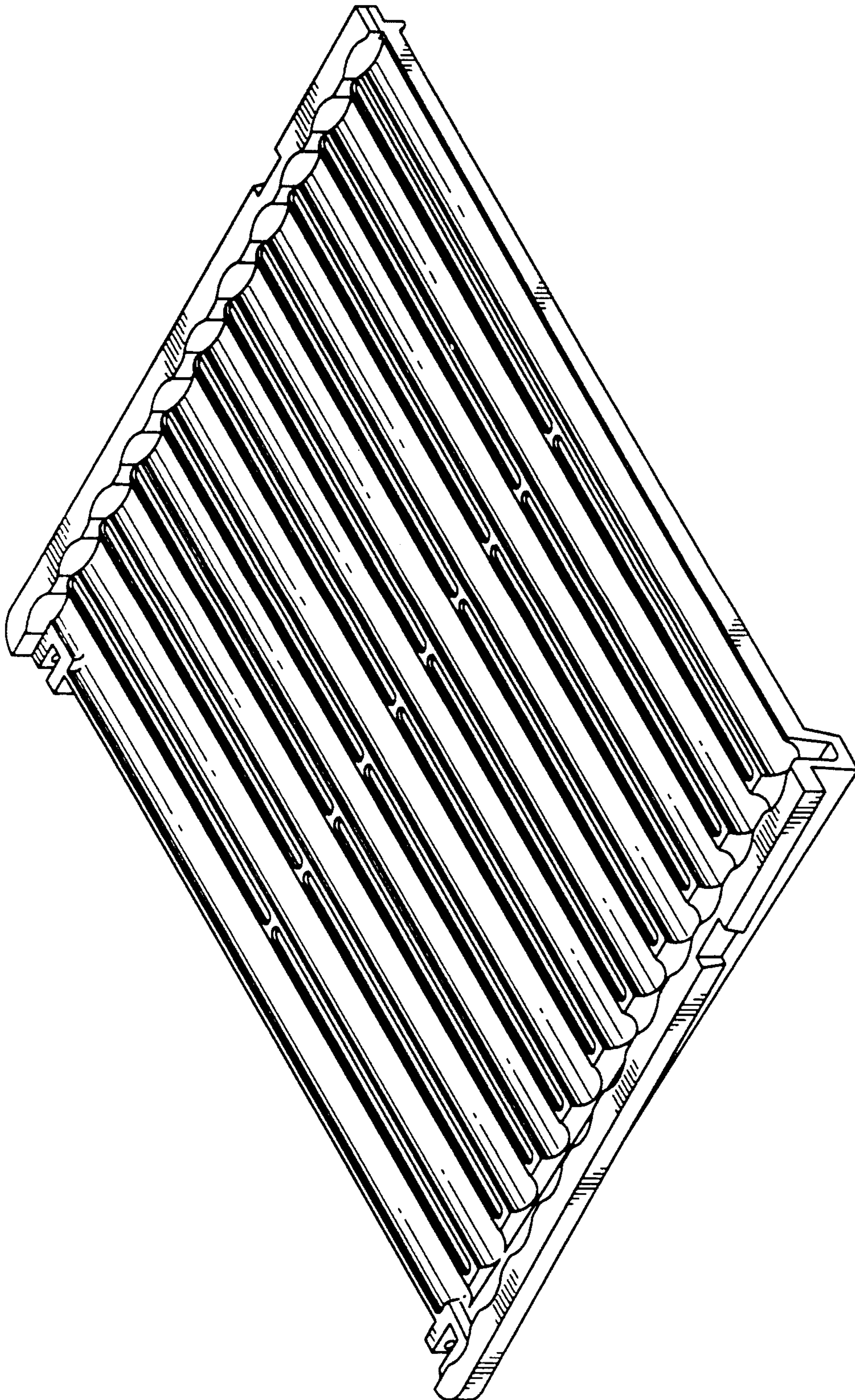

FIG. 9

FIG.10

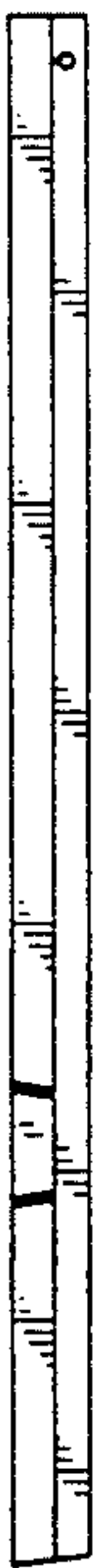

FIG.16



FIG.11



FIG.12

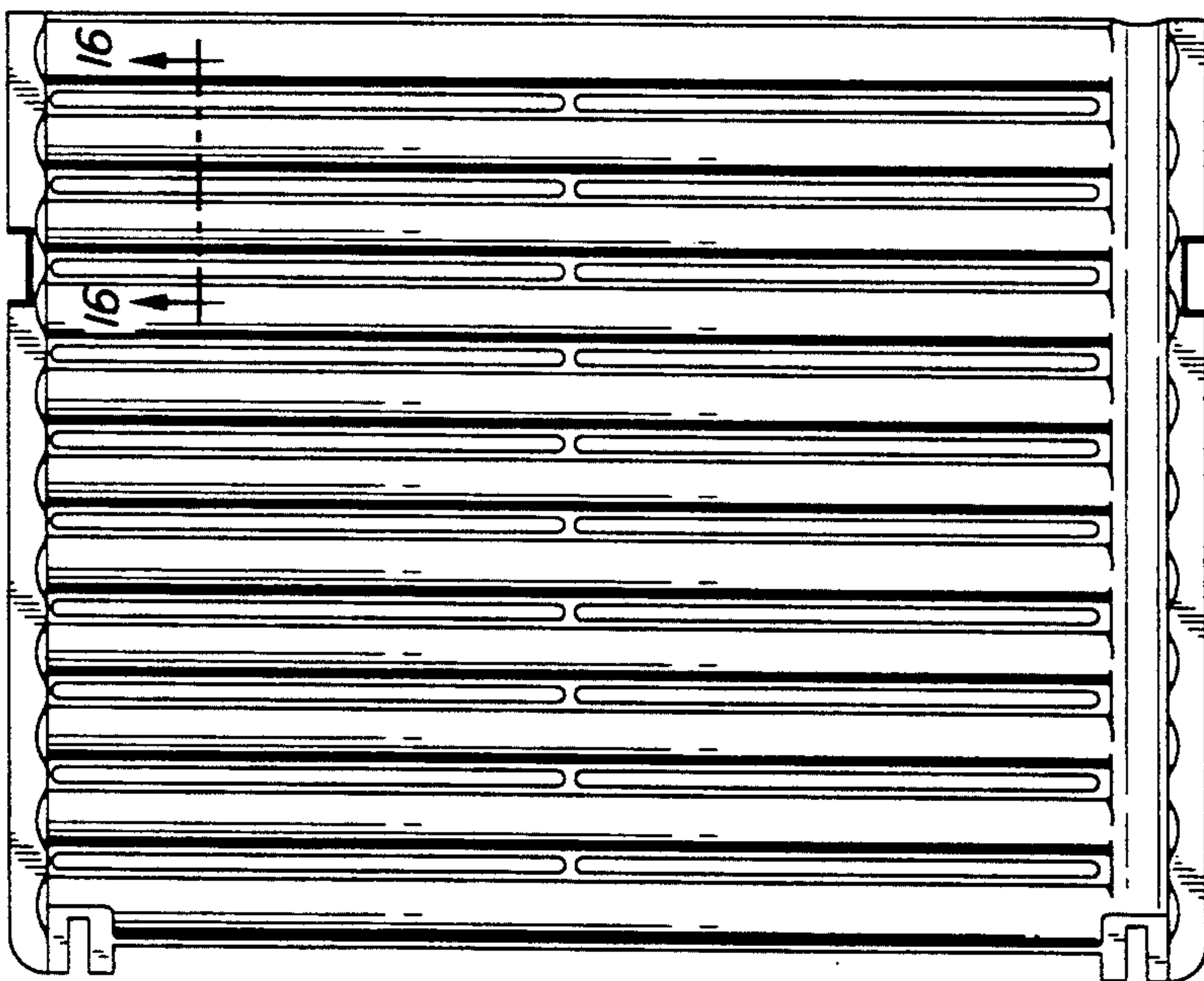

FIG.13

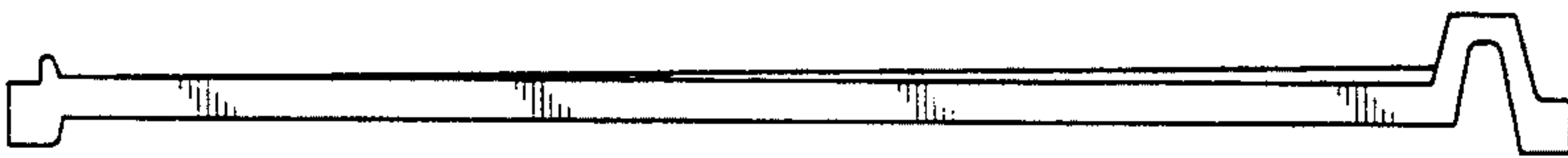

FIG.14

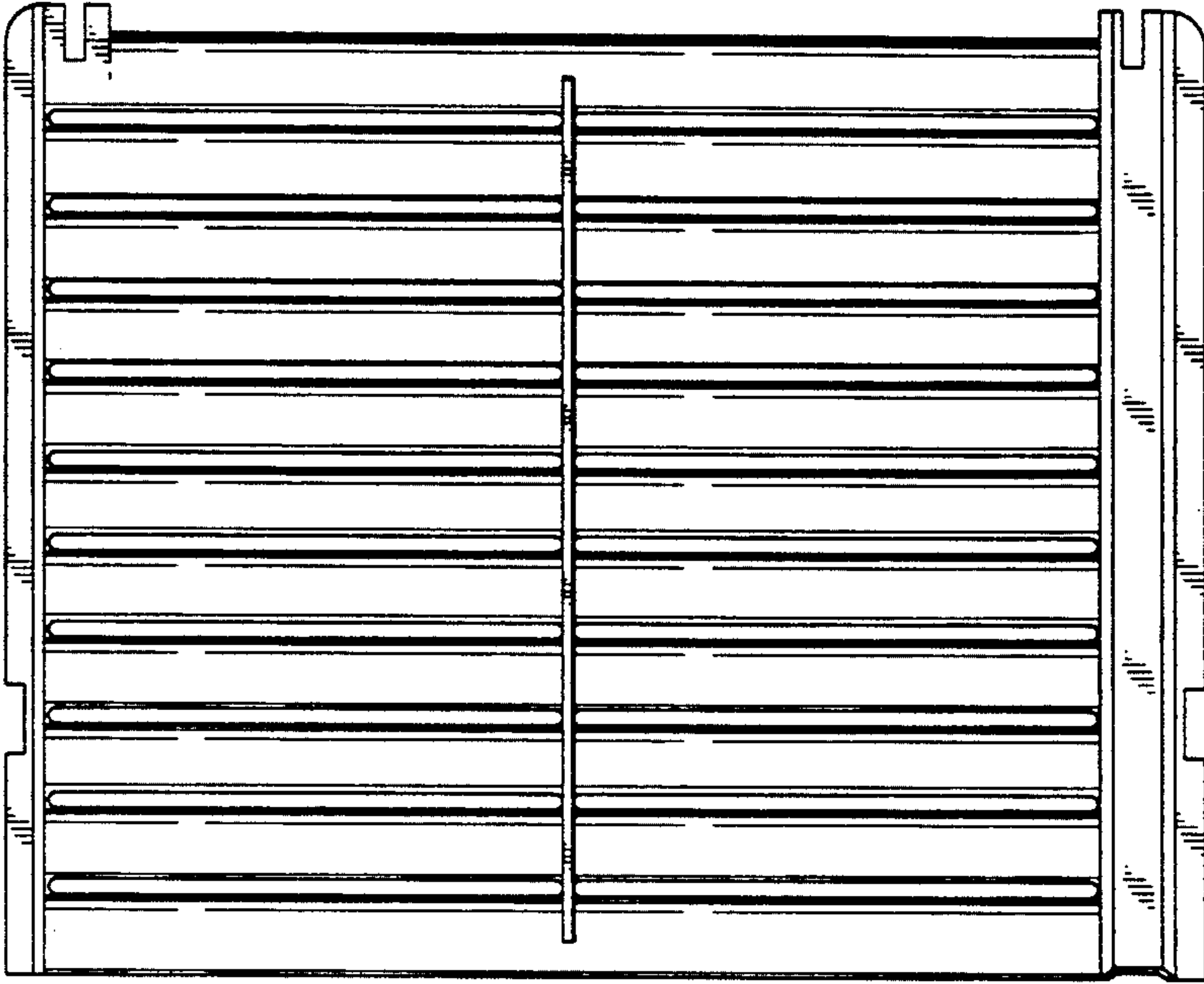

FIG.15





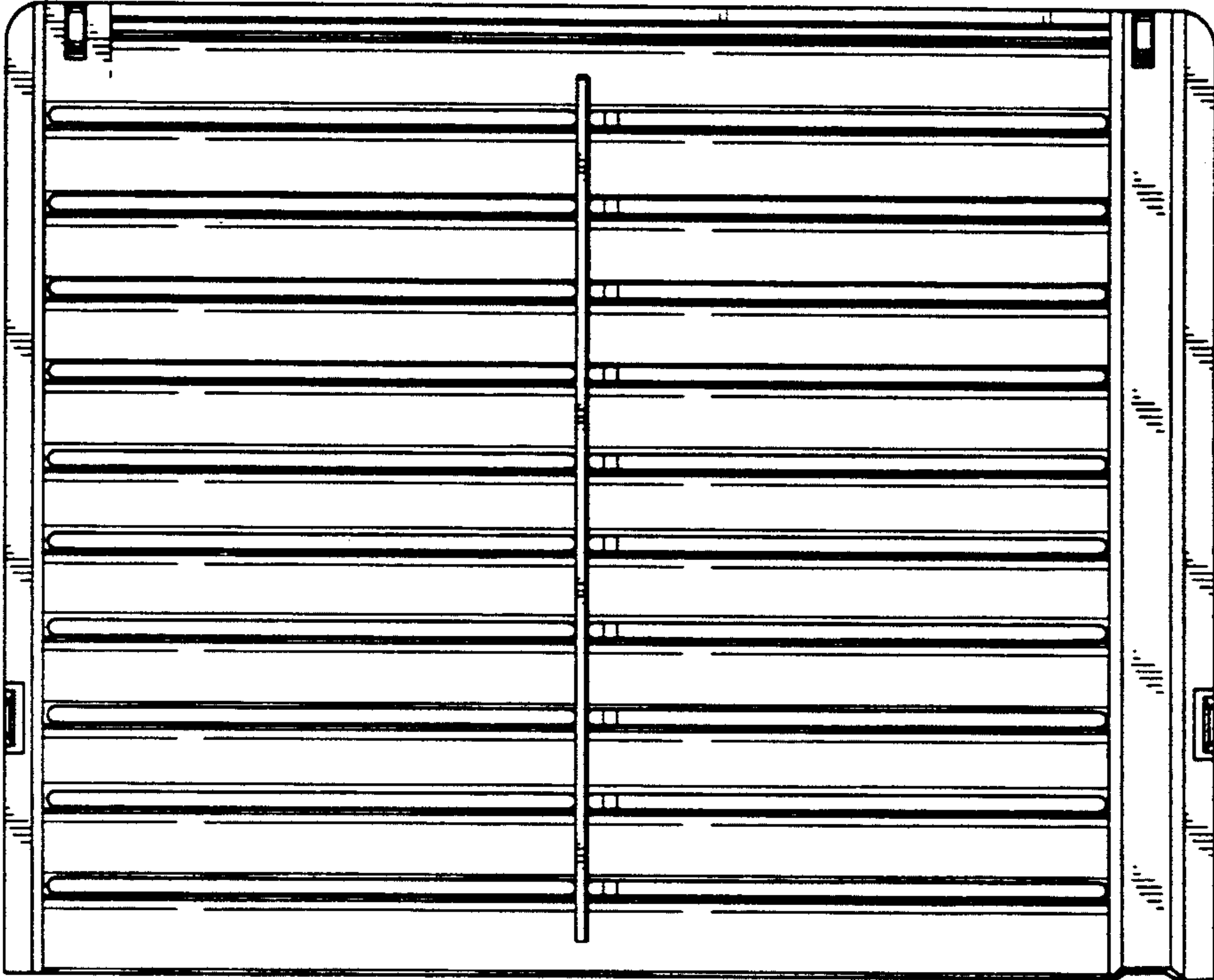

FIG. 18

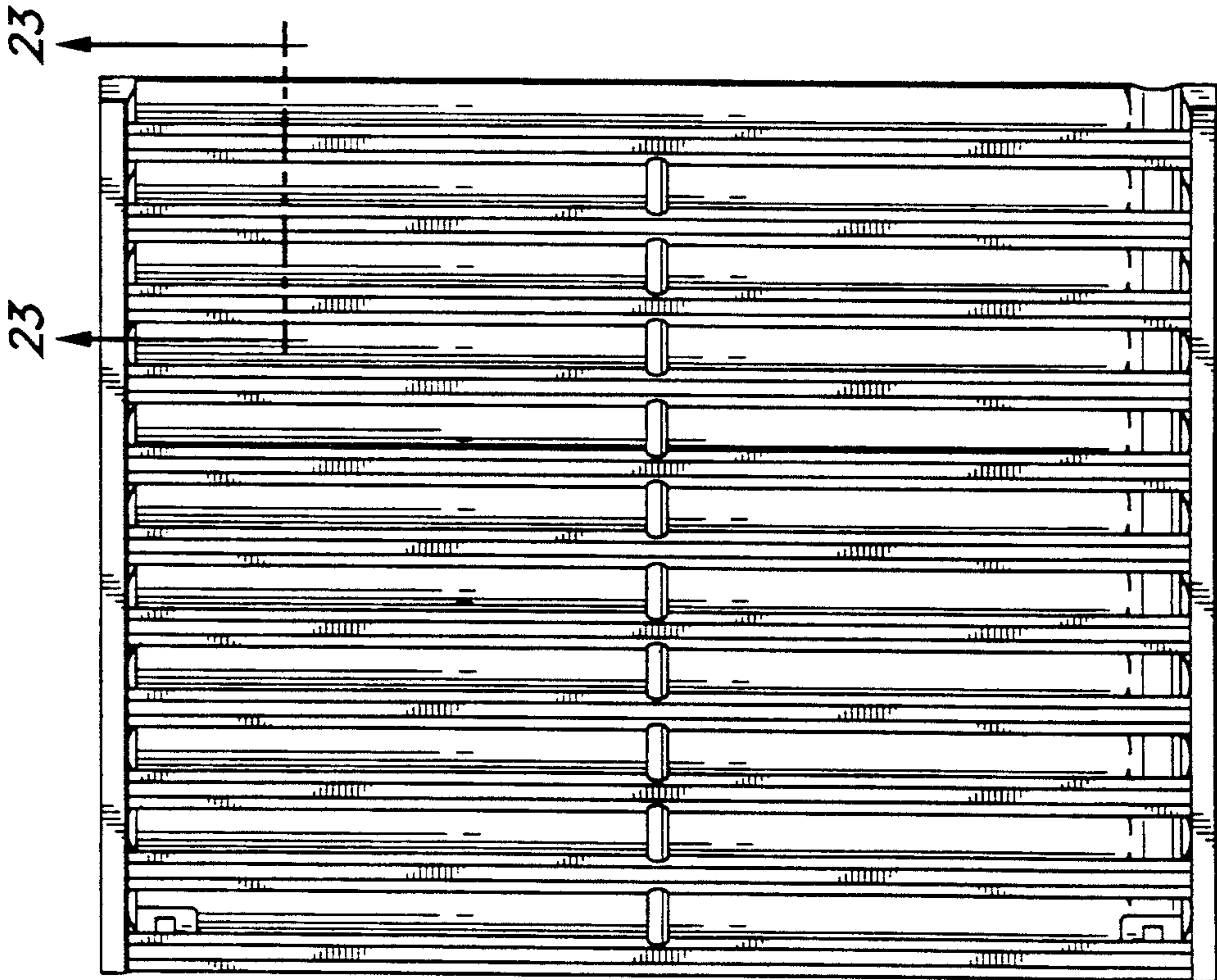

FIG. 17

FIG. 19

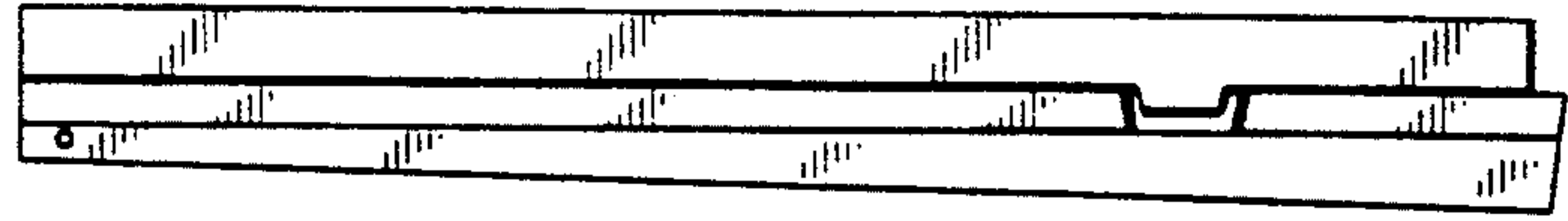

FIG. 20

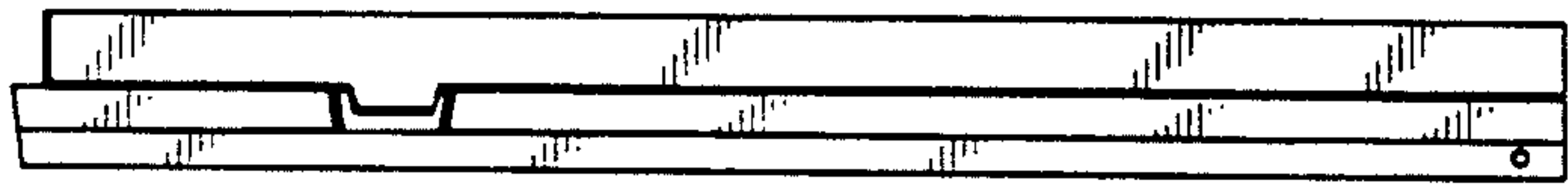

FIG. 21



FIG. 22

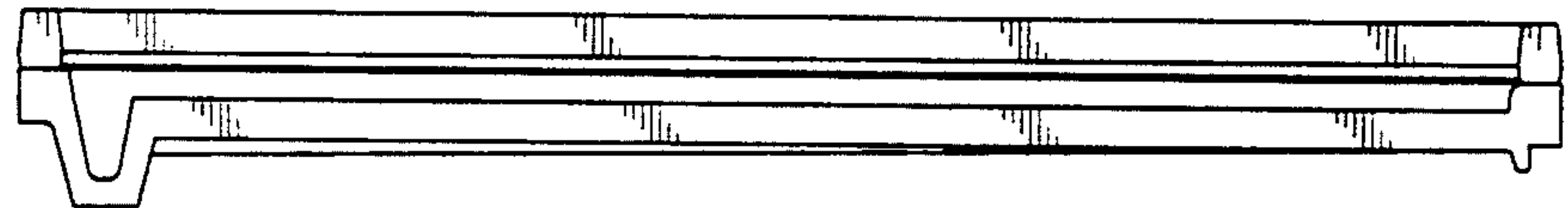

FIG. 23

