



US00D340719S

United States Patent [19]

[11] Patent Number: **Des. 340,719**

Yoder

[45] Date of Patent: **** Oct. 26, 1993**

[54] **ANTENNA MOUNTING CLAMP**

[57] **CLAIM**

[75] Inventor: **Ronald L. Yoder, Topeka, Ind.**

The ornamental design for an antenna mounting clamp, as shown and described.

[73] Assignee: **Universal Consolidated Methods, Inc., Topeka, Ind.**

DESCRIPTION

[**] Term: **14 Years**

FIG. 1 is a front, bottom and right perspective view of an antenna mounting clamp illustrating my new design; FIG. 2 is a right side elevational view of the side shown in FIG. 1 with the view from the opposite side being substantially the mirror image thereof; FIG. 3 is a top plan view thereof; FIG. 4 is a bottom plan view thereof; FIG. 5 is a front elevation view thereof; FIG. 6 is a rear elevation view thereof; FIG. 7 is a top plan view of a second embodiment of the antenna mounting clamp illustrated in FIG. 1; FIG. 8 is a bottom plan view of the embodiment disclosed in FIG. 7; FIG. 9 is a front elevation view thereof; FIG. 10 is a rear elevation view thereof; FIG. 11 is a top plan view of a third embodiment of the antenna mounting clamp illustrated in FIG. 1; FIG. 12 is a bottom plan view of the embodiment disclosed in FIG. 11; FIG. 13 is a front elevation view thereof; FIG. 14 is a rear elevation view thereof; and, FIG. 15 is a right side elevational view of the embodiments of FIGS. 7-14 with the views from the opposite sides being substantially the mirror images thereof.

[21] Appl. No.: **588,957**

[22] Filed: **Sep. 26, 1990**

[52] U.S. Cl. **D14/238; D8/396**

[58] Field of Search **D14/230-238, D14/124, 217, 219; 343/711-713, 715, 872, 900, 906, 741, 748, 882, 720, 808, 805, 878, 795, 912, 873, 745, 749, 901, 903; D8/376, 380, 396**

[56] References Cited

U.S. PATENT DOCUMENTS

D. 221,928	9/1971	Zucconi	D8/396
D. 279,473	7/1985	Hochstetler et al.	D14/238
D. 294,702	3/1988	Yoder	D14/238
D. 311,189	10/1990	Lazzeroni et al.	D8/396 X
3,967,275	6/1976	Wagman	343/715 X
5,020,765	6/1991	Evans et al.	343/715 X

Primary Examiner—Theodore M. Shooman
Attorney, Agent, or Firm—Roger M. Rickert

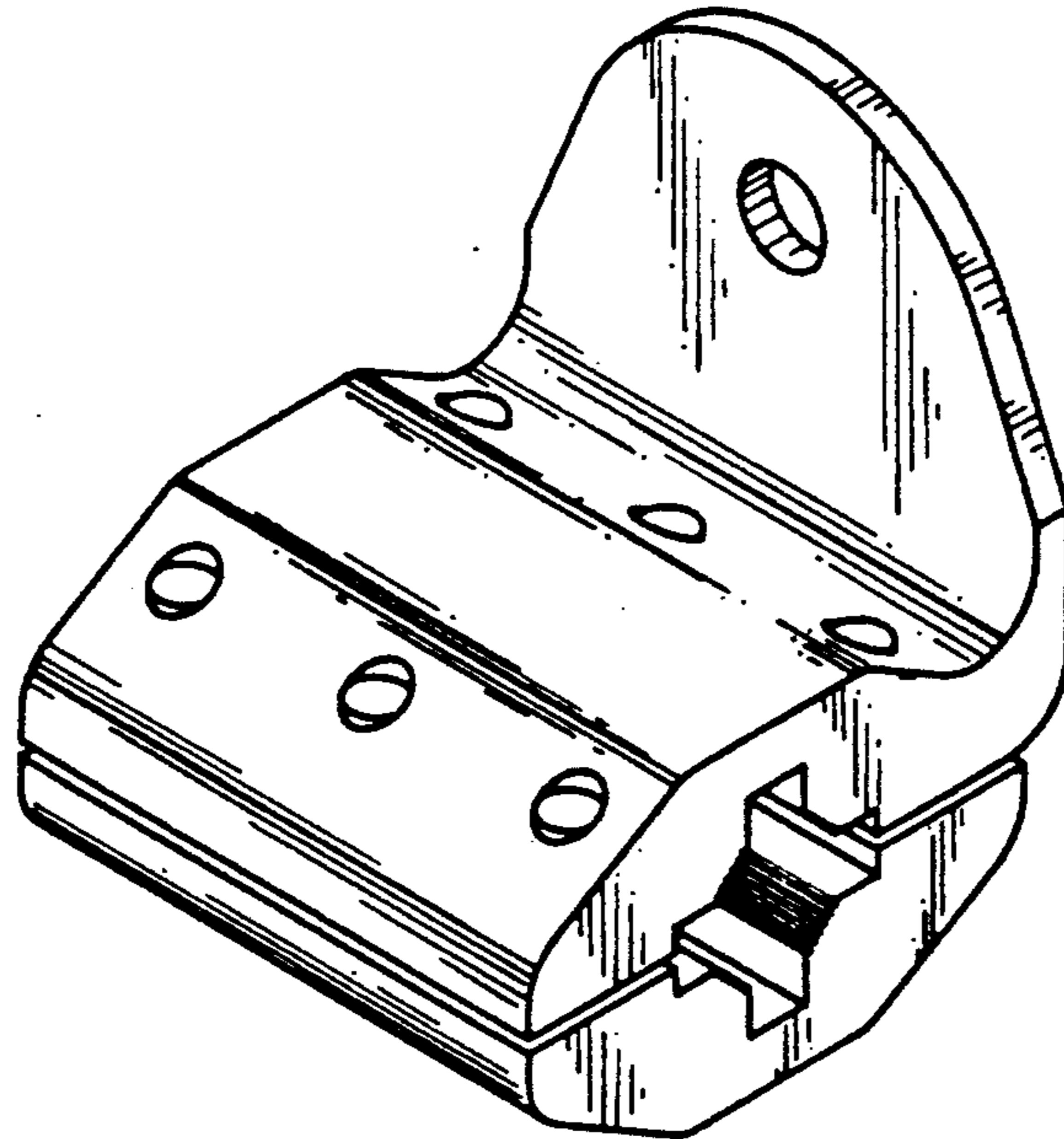

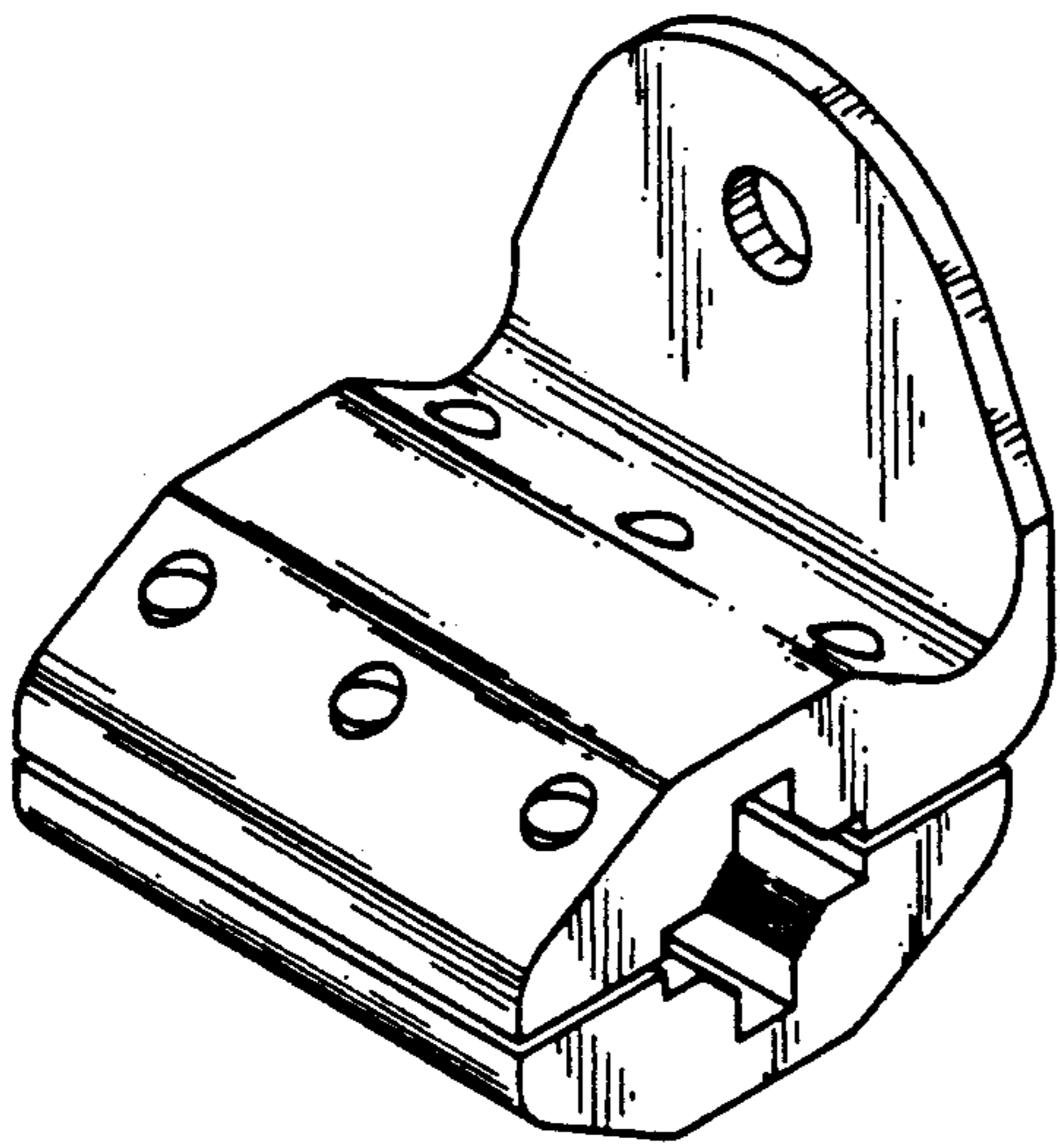

FIG. 1

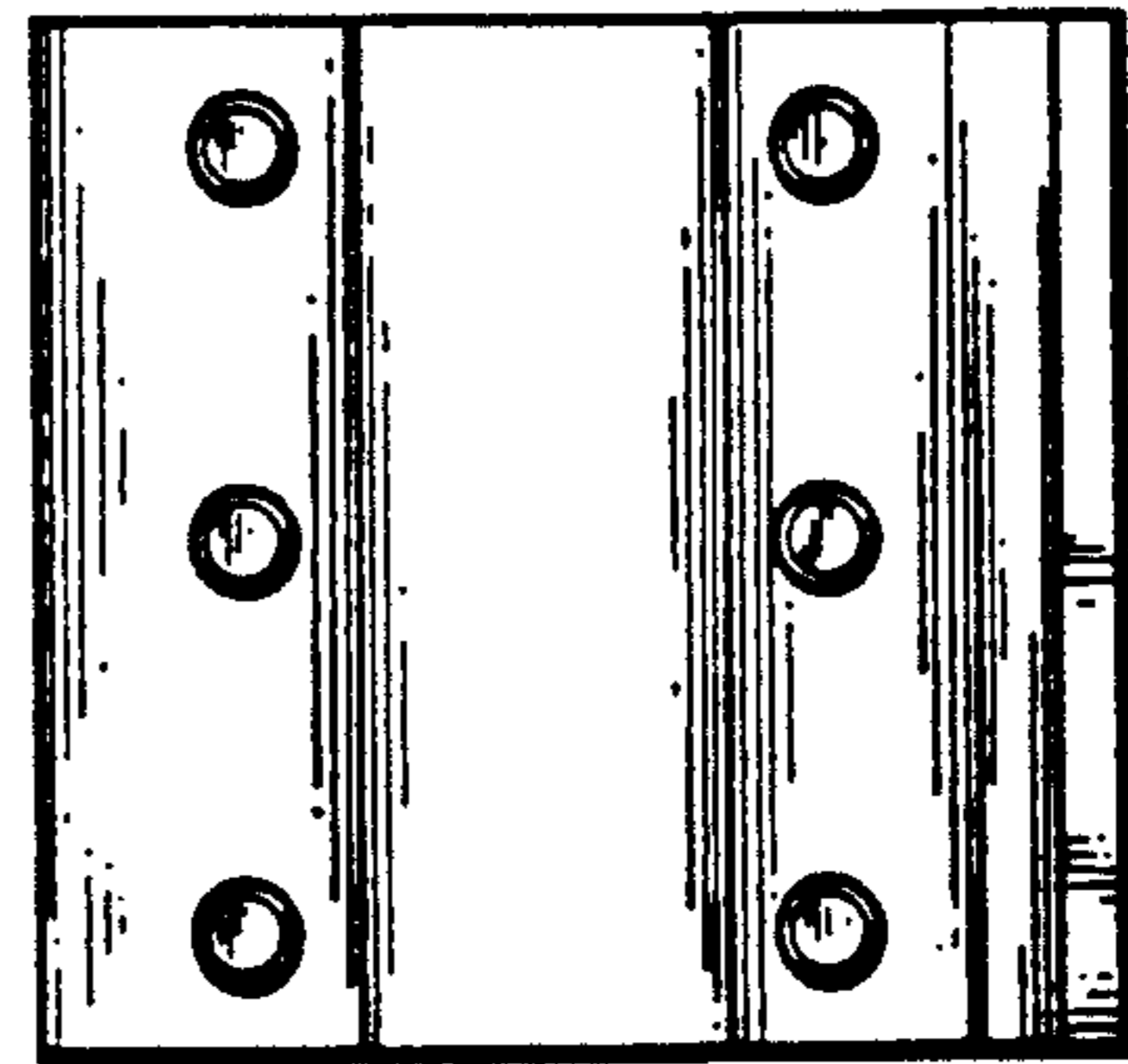

FIG. 5

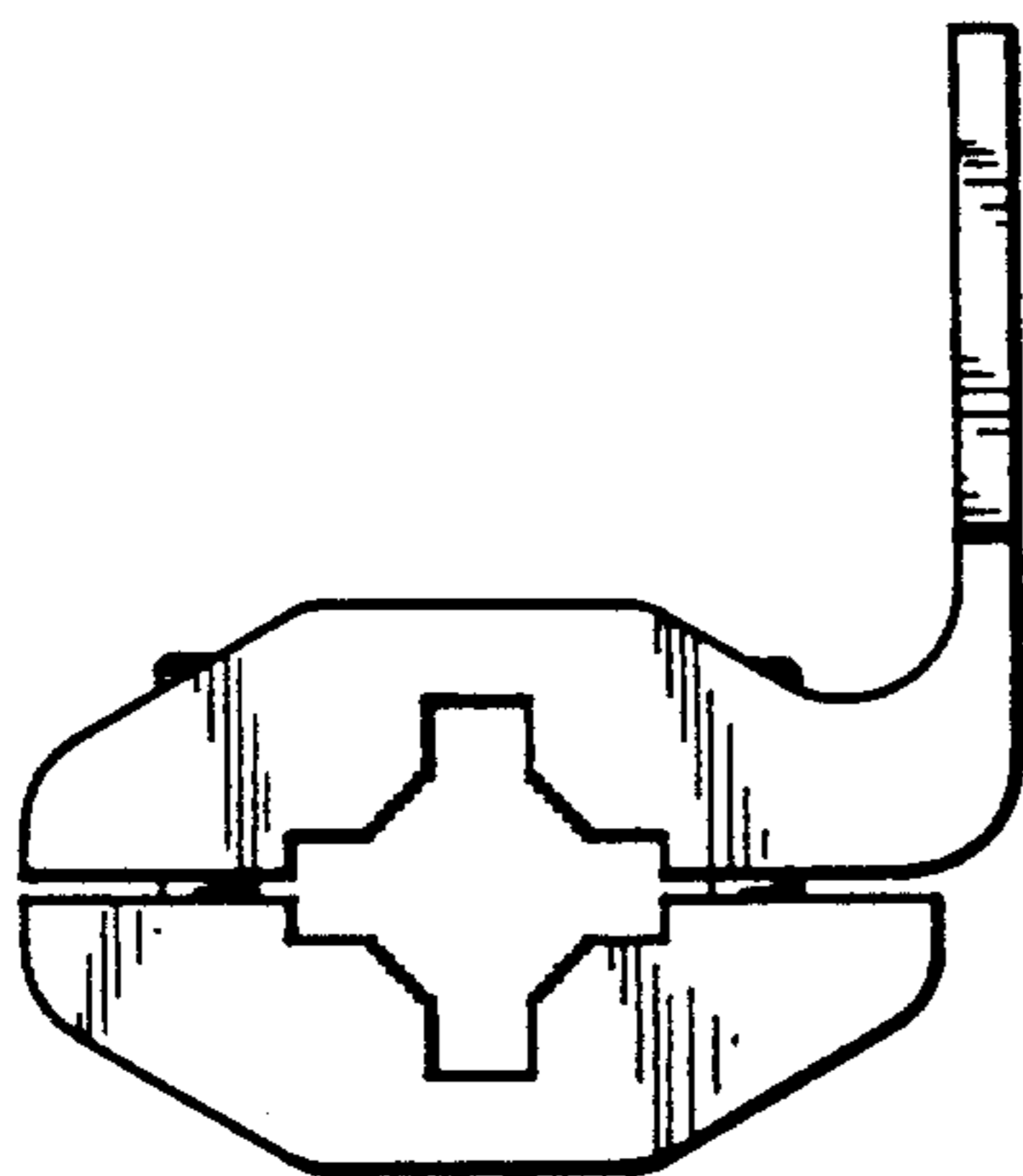

FIG. 2

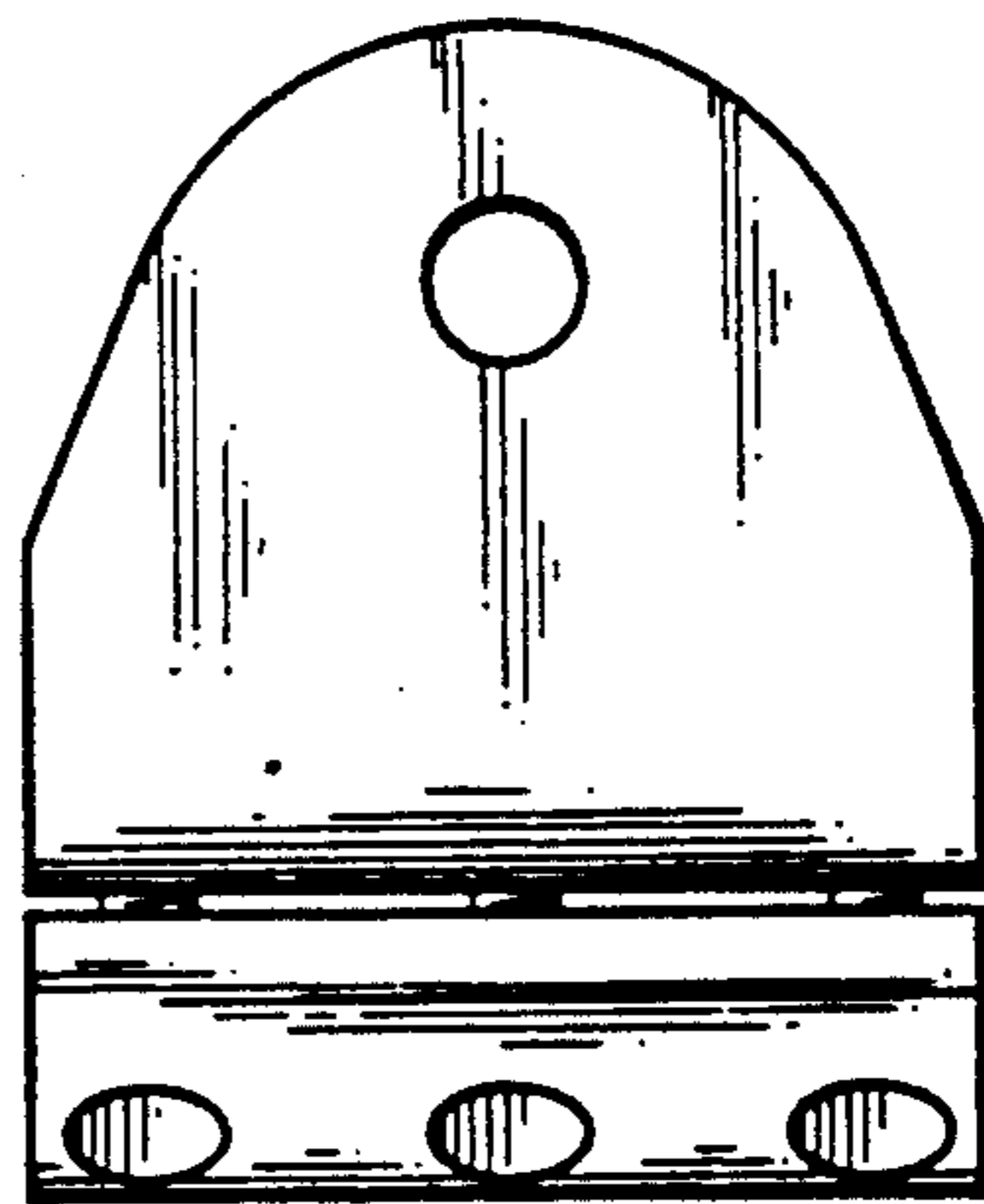

FIG. 3

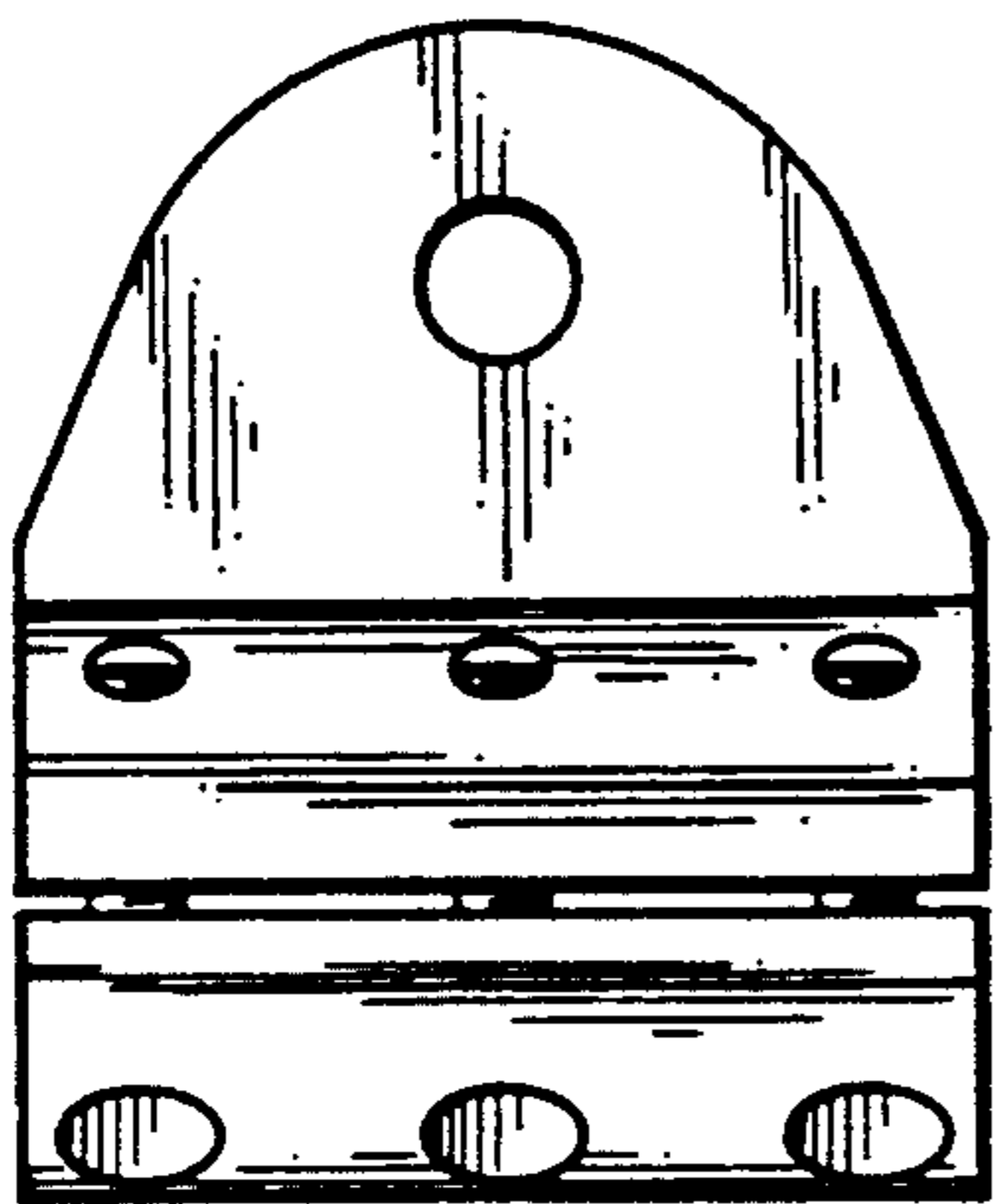

FIG. 4

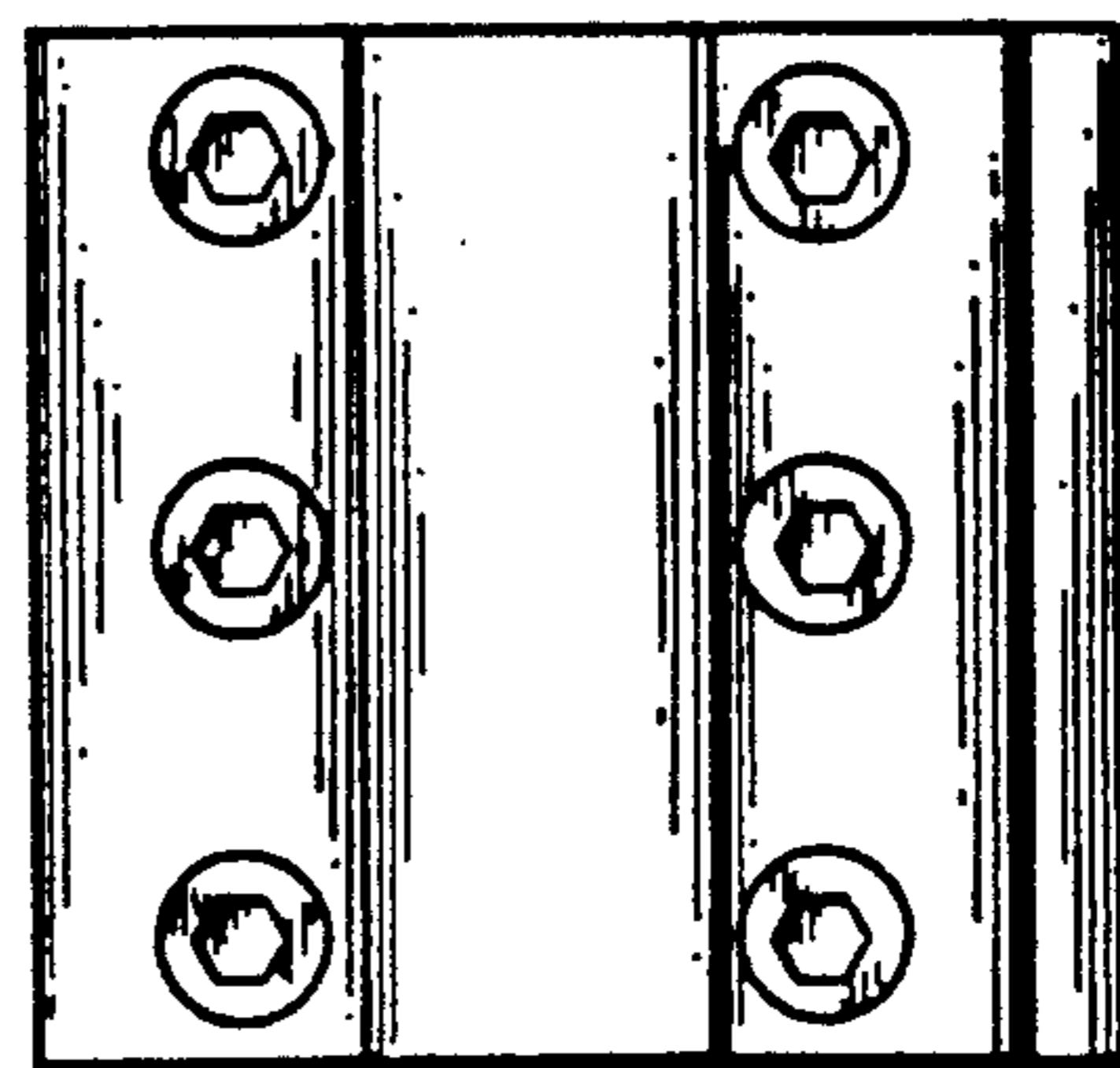

FIG. 6

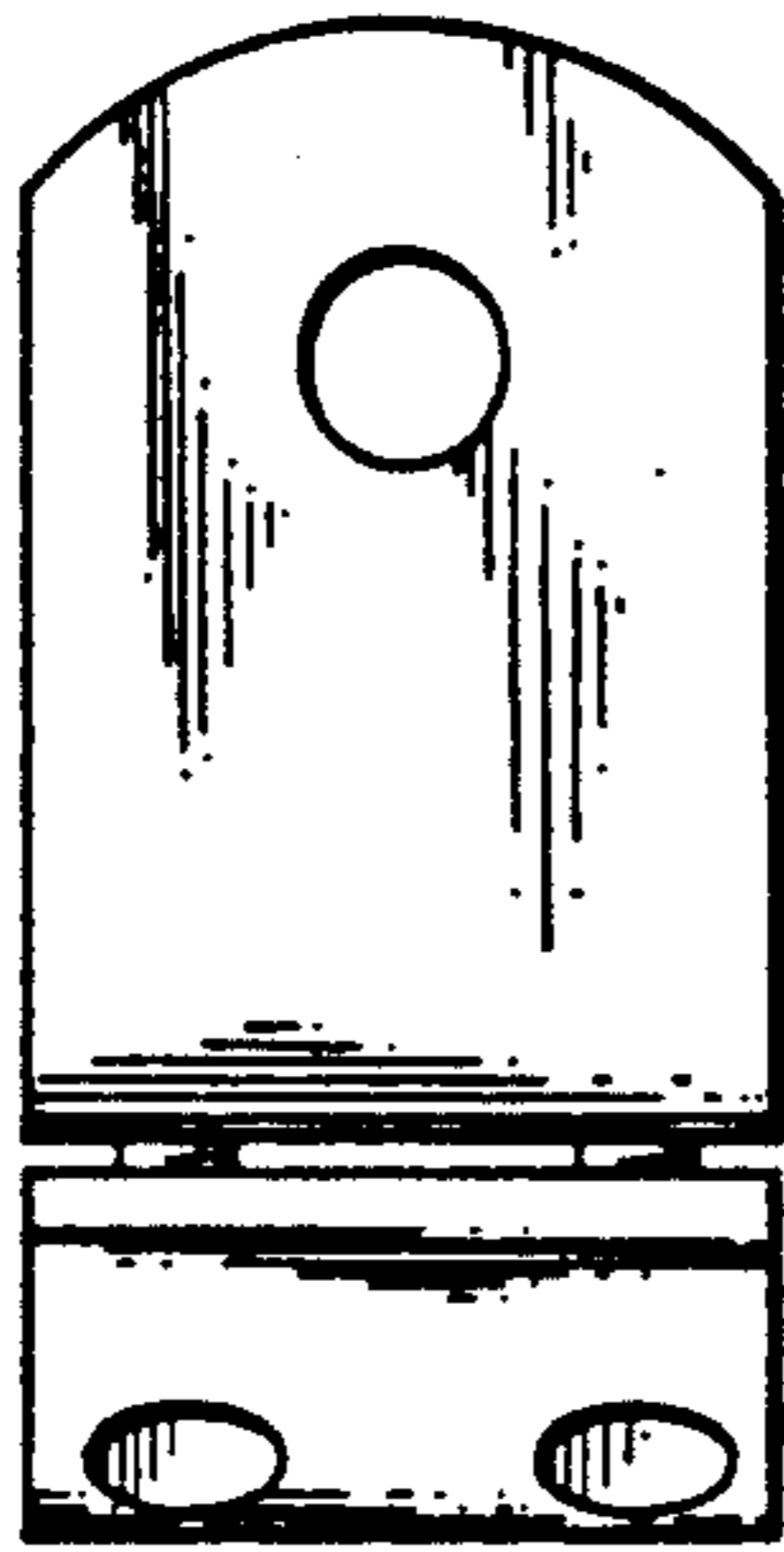

FIG. 7

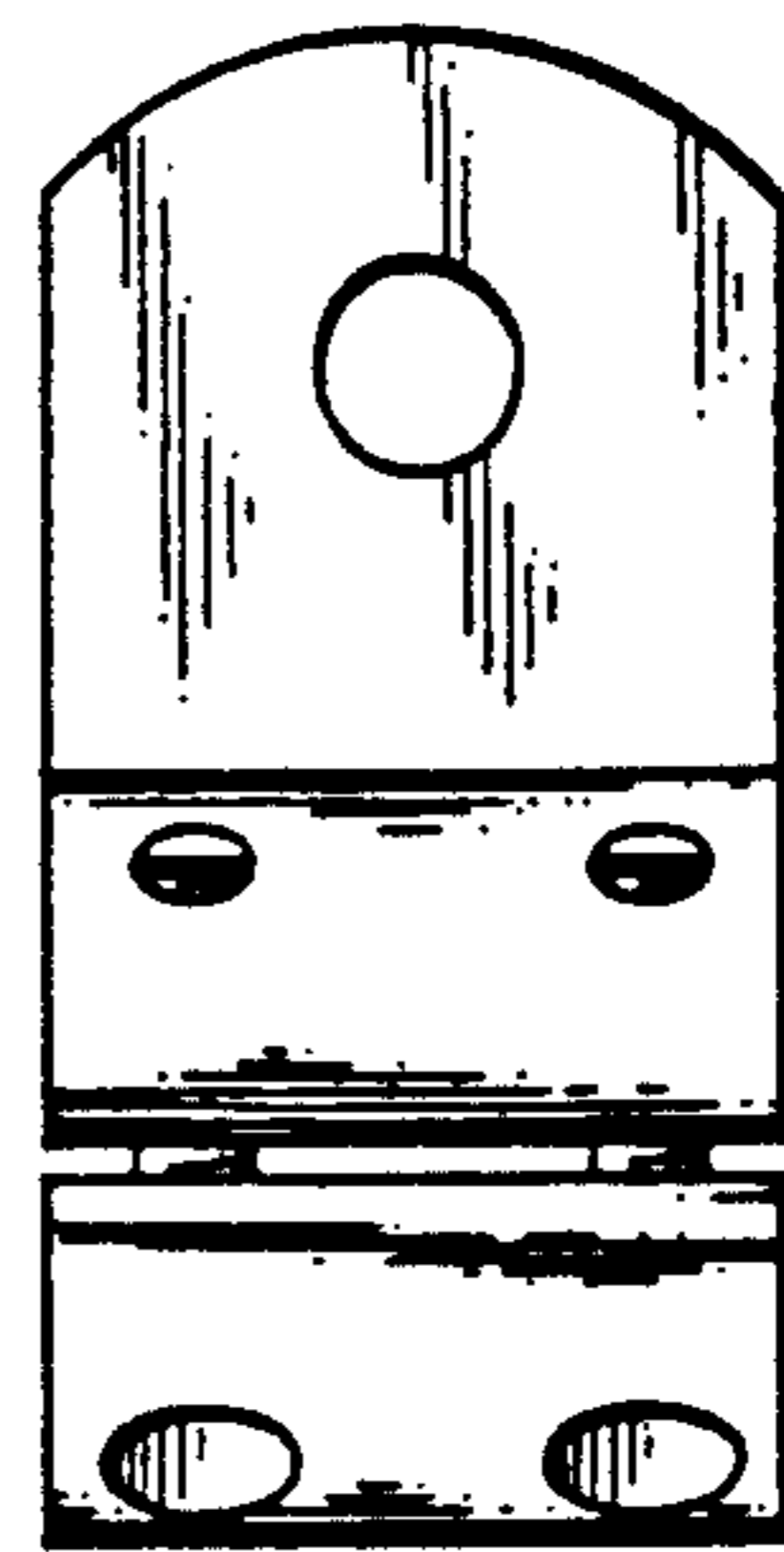

FIG. 8

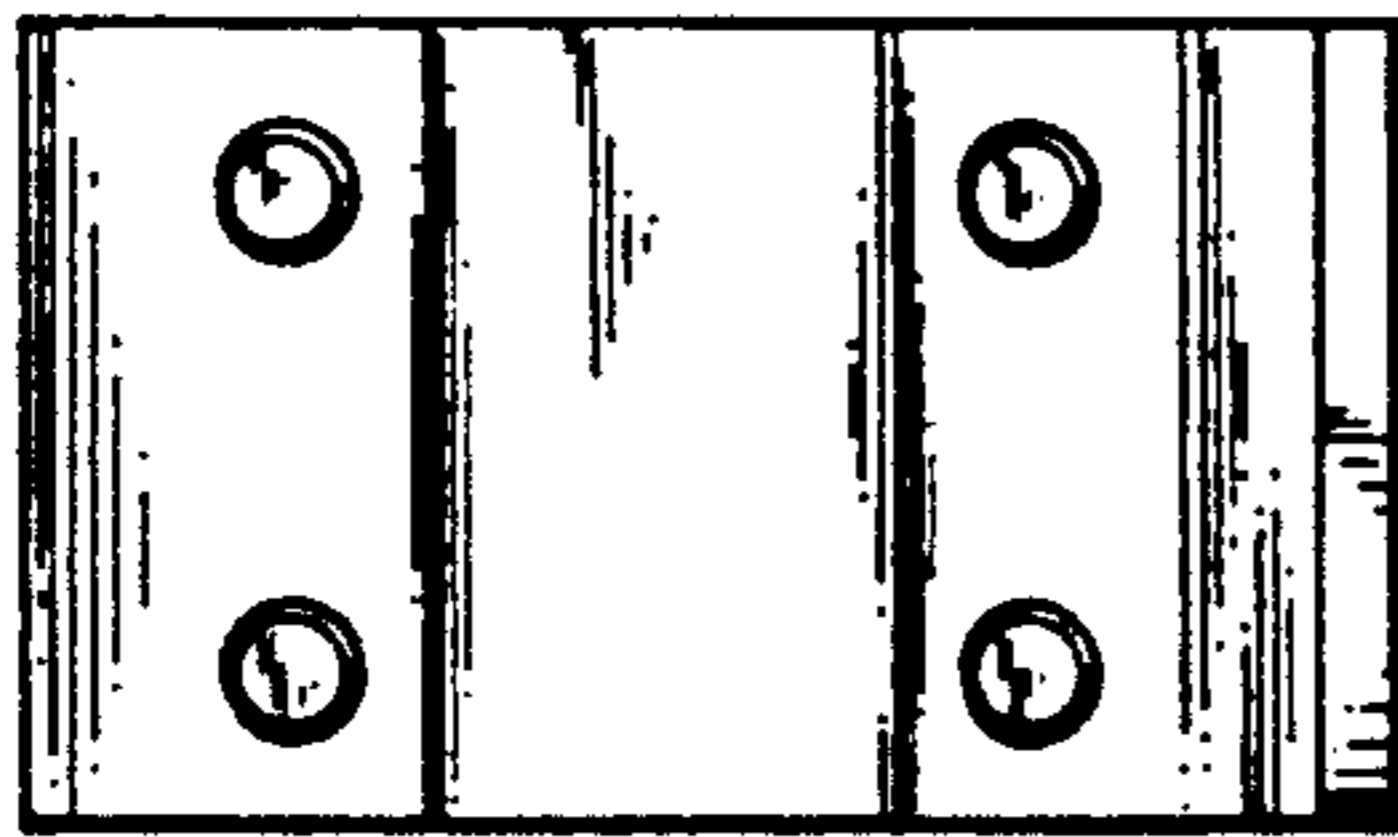

FIG. 9

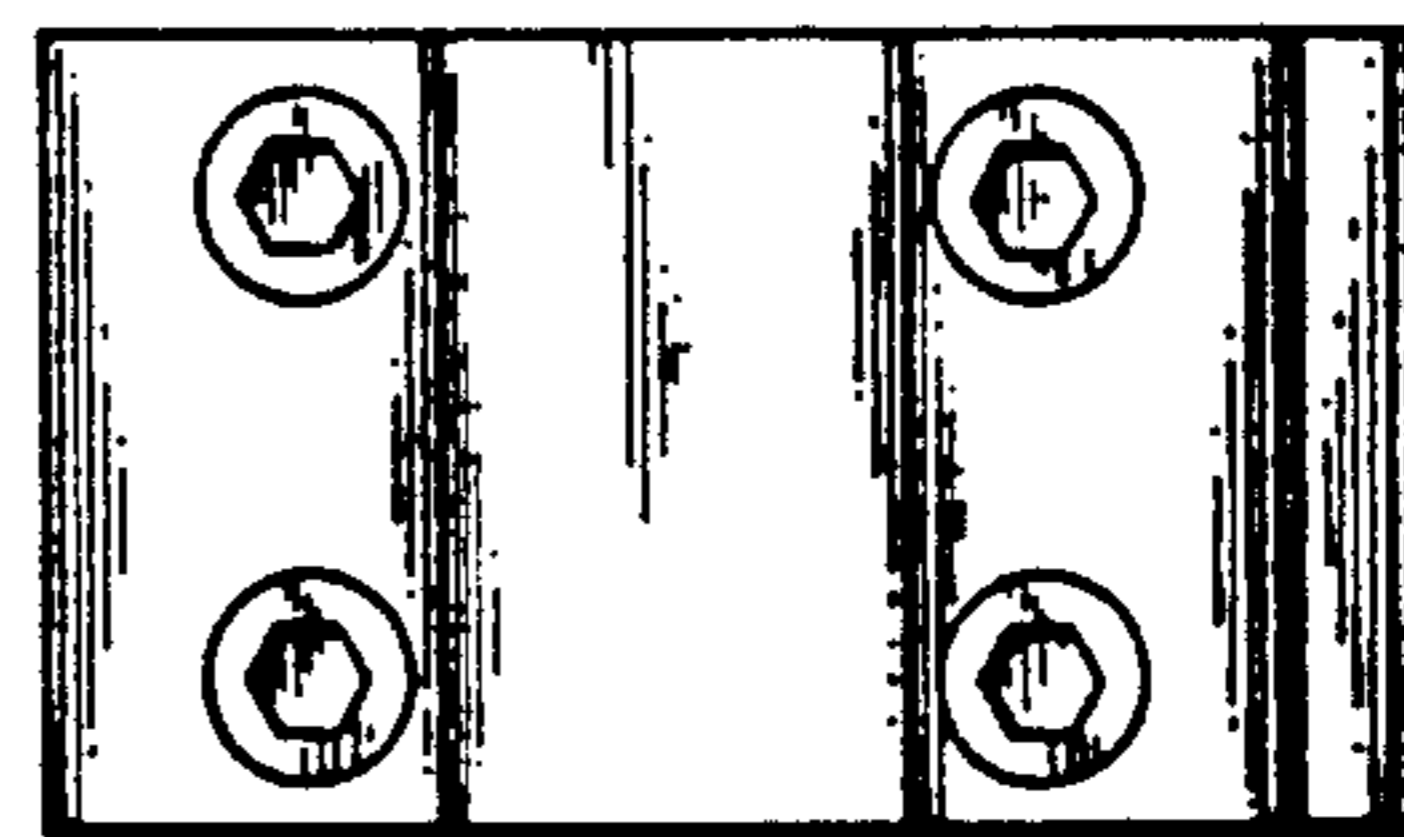

FIG. 10



FIG. 11

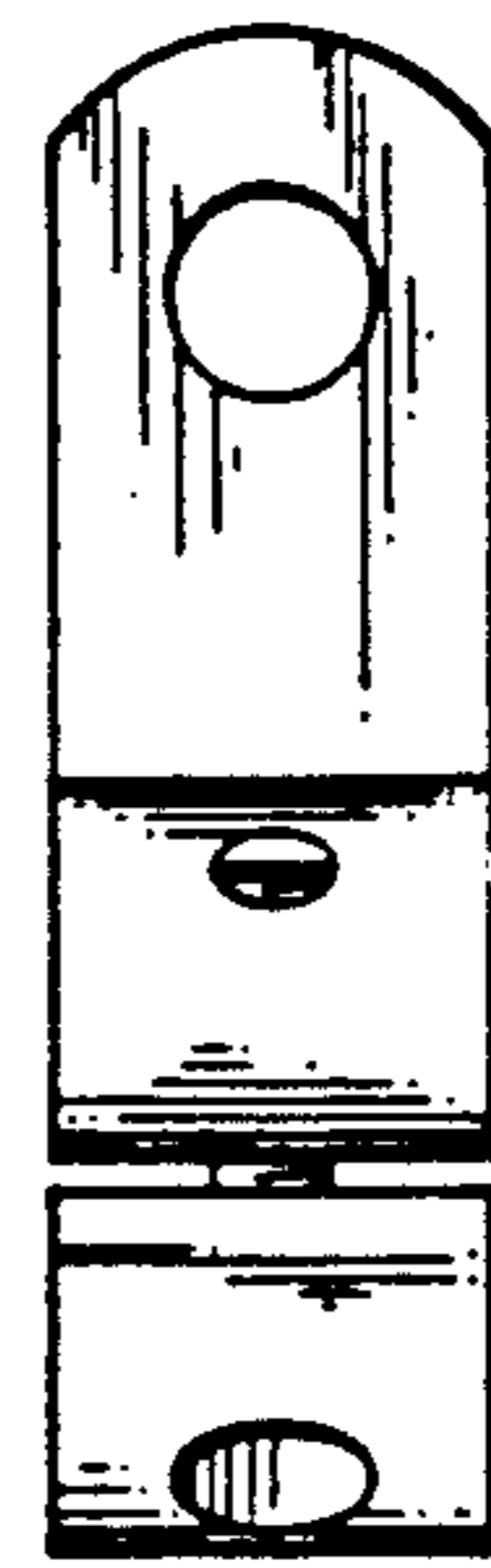

FIG. 12

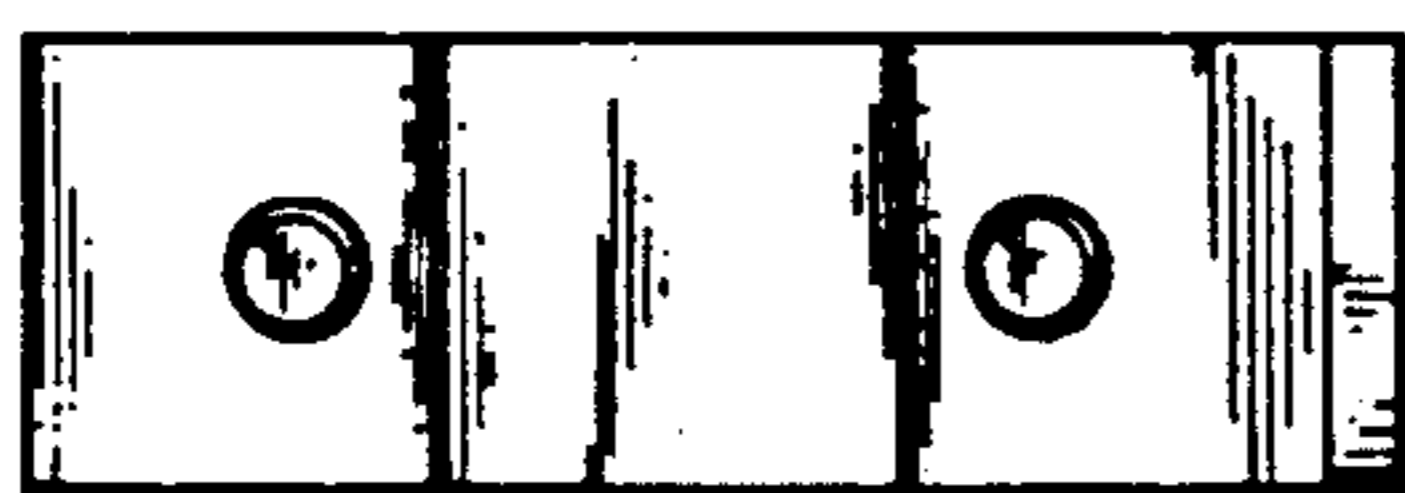

FIG. 13

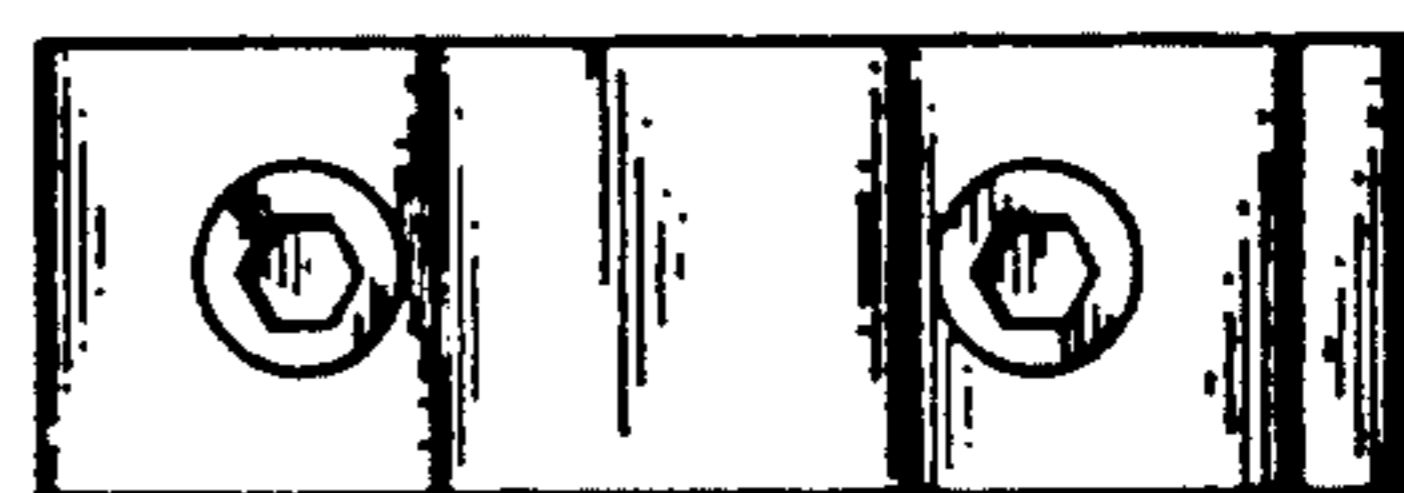

FIG. 14

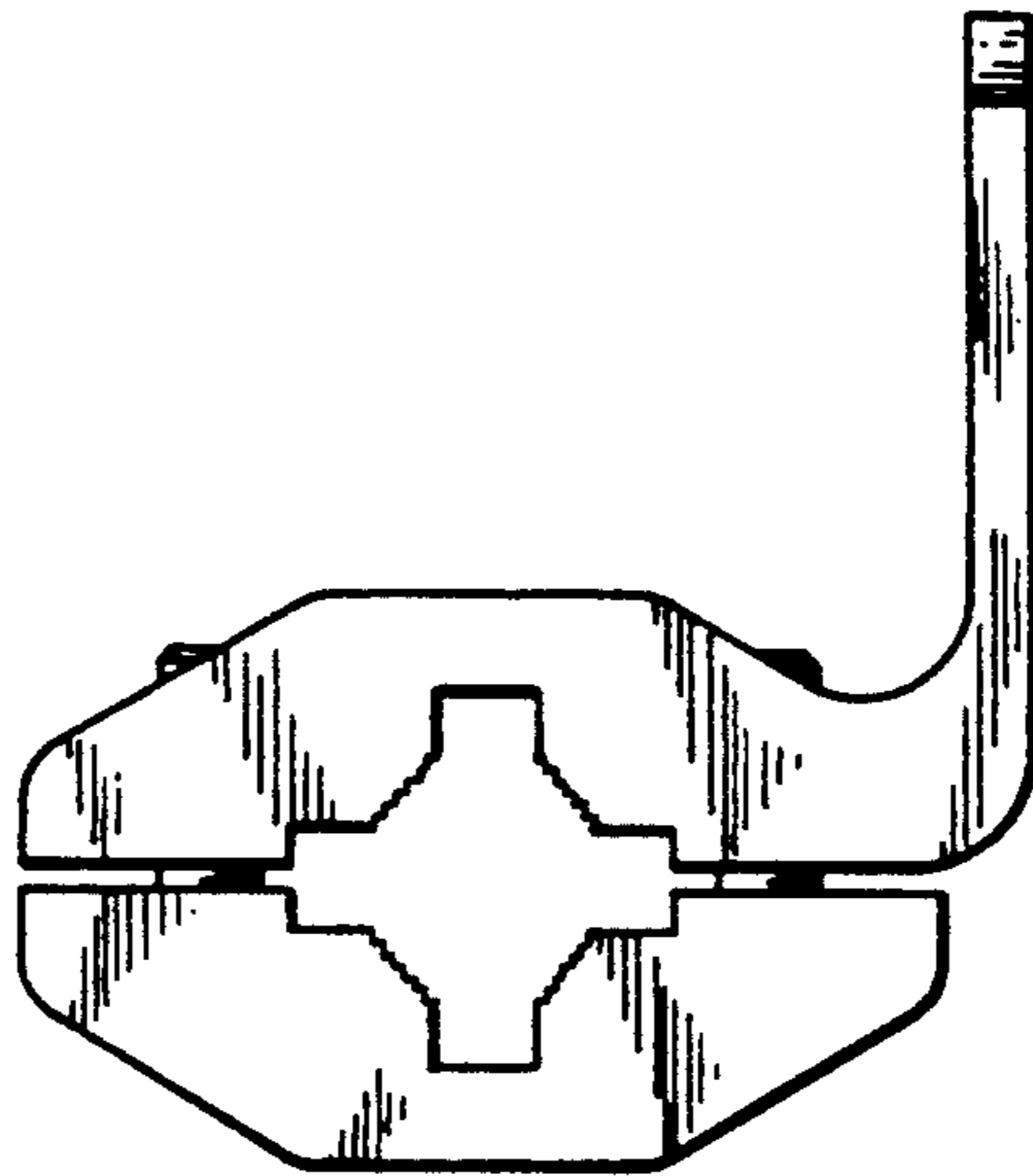

FIG. 15