



US00D340695S

United States Patent [19]

[11] Patent Number: **Des. 340,695**

Merriman et al.

[45] Date of Patent: **** Oct. 26, 1993**

[54] **RETAINER FOR A CONNECTED ELECTRICAL EXTENSION CORD**

2605810 4/1988 France 439/369

[76] Inventors: **Daniel S. Merriman; Marianne Merriman**, both of 9545 Farmington Dr., Lakeside, Calif. 92040

OTHER PUBLICATIONS

Apple Talk clips on p. 23 of 1988 *Business Land* catalog.

[**] Term: **14 Years**

Primary Examiner—Wallace R. Burke

Assistant Examiner—Joel Sincavage

Attorney, Agent, or Firm—Leon Gilden

[21] Appl. No.: **880,974**

[57] CLAIM

[22] Filed: **May 11, 1992**

The ornamental design for a retainer for a connected electrical extension cord, as shown and described.

[52] U.S. Cl. **D13/154**

DESCRIPTION

[58] Field of Search **D13/154, 137; D8/356; 439/369, 533**

FIG. 1 is a front elevational view of the retainer for a connected electrical extension cord showing my new design;

[56] References Cited

U.S. PATENT DOCUMENTS

D. 332,940	2/1993	Finlay	D13/154
2,761,109	8/1956	Hacker	439/369
4,206,961	6/1980	Cifalde	439/369
4,925,399	5/1990	Bosworth et al.	439/369 X
4,998,891	3/1991	Bresko	D13/137 X

FIG. 2 is a rear elevational view thereof;

FIG. 3 is a left side elevational view thereof;

FIG. 4 is a right side elevational view thereof;

FIG. 5 is a top plan view thereof;

FIG. 6 is a bottom plan view thereof; and,

FIG. 7 is an isometric view thereof showing the retainer in use. The broken line showing of the extension cord is included for the purpose of illustrating environmental elements only and forms no part of the claimed design.

FOREIGN PATENT DOCUMENTS

0818717	7/1969	Canada	439/369
---------	--------	--------	-------	---------

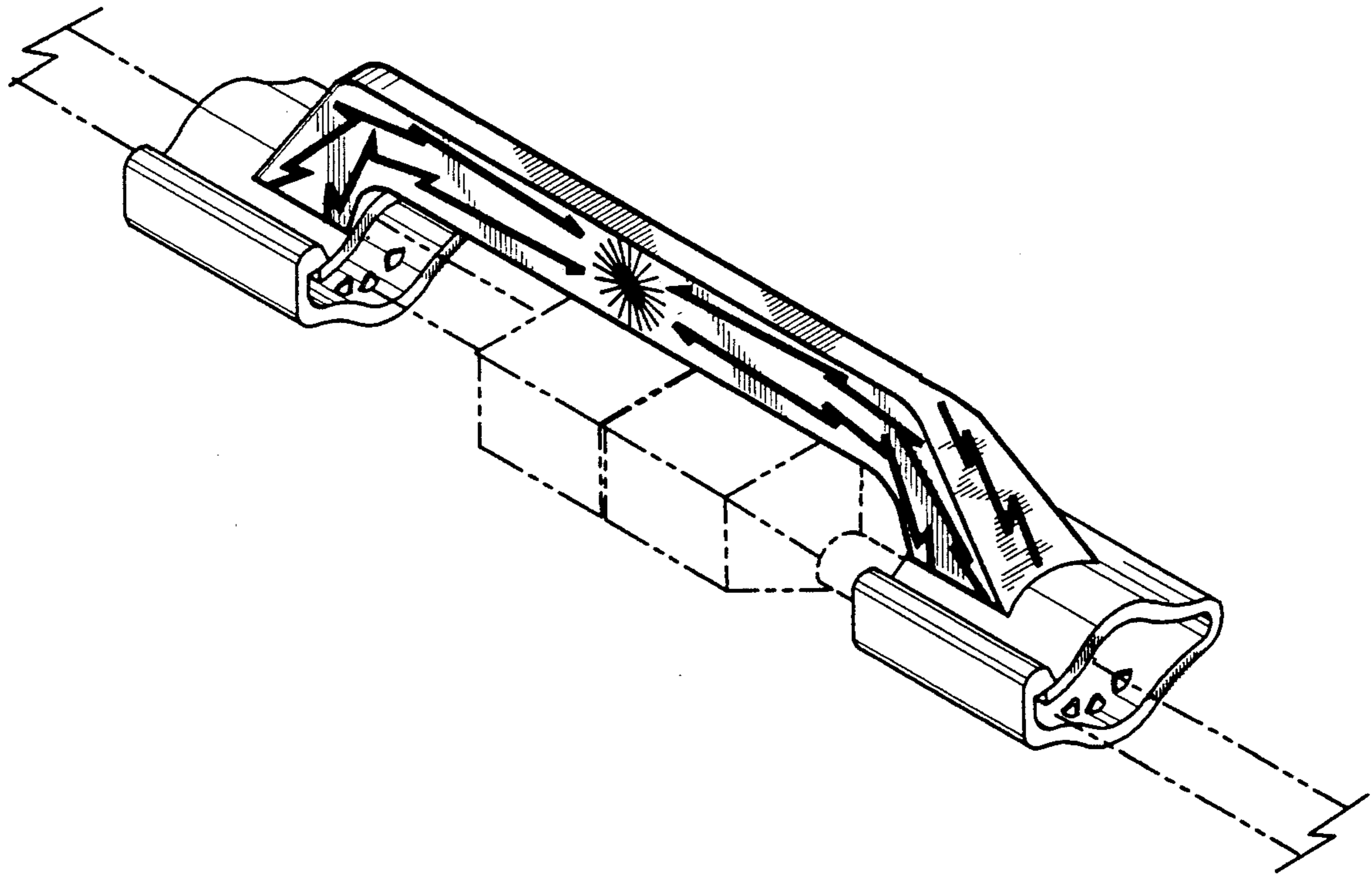

FIG. 1

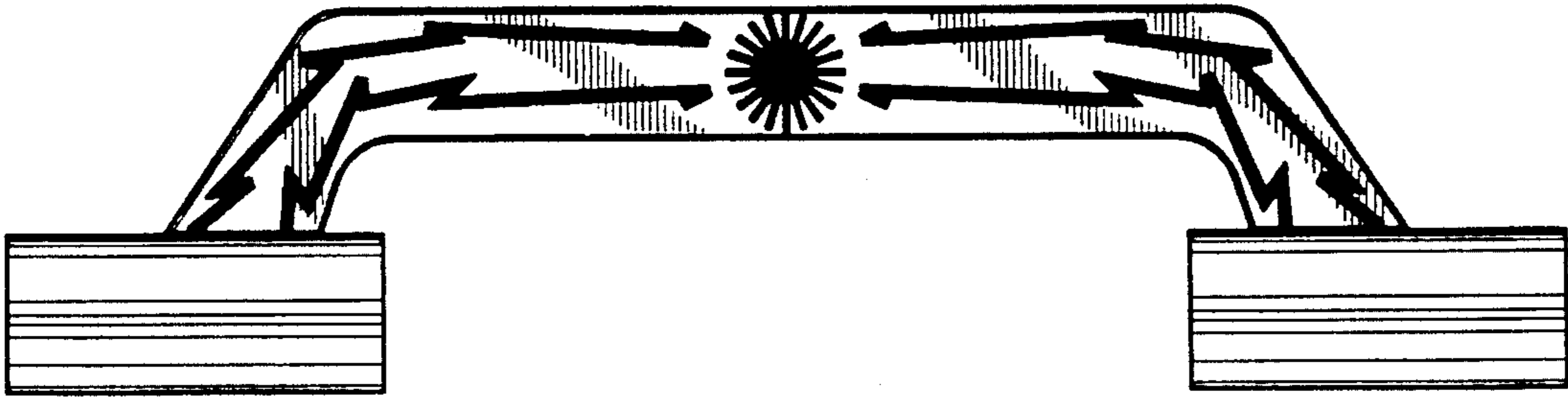
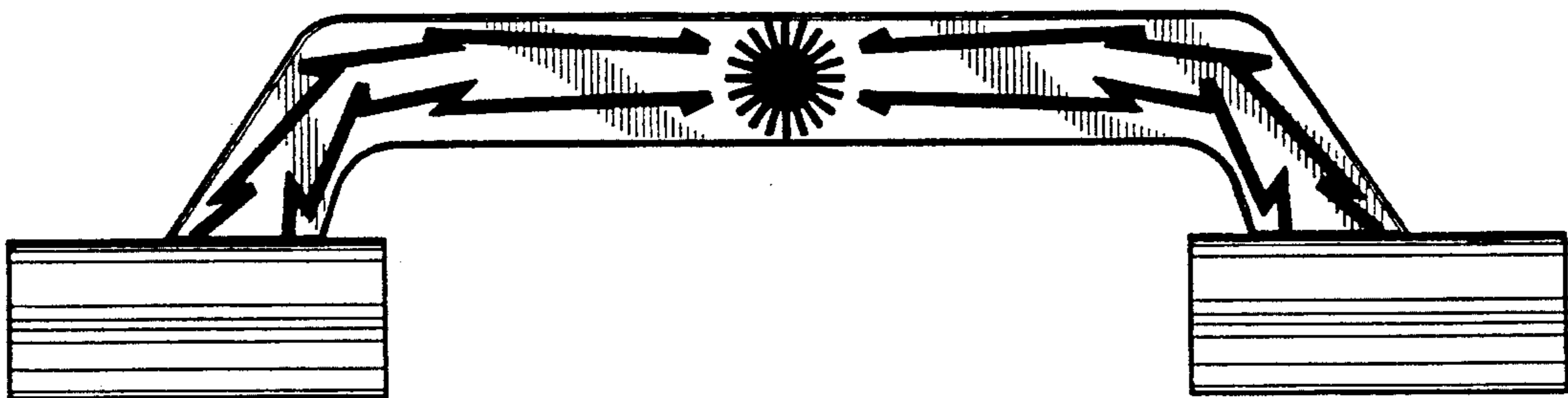

FIG. 2



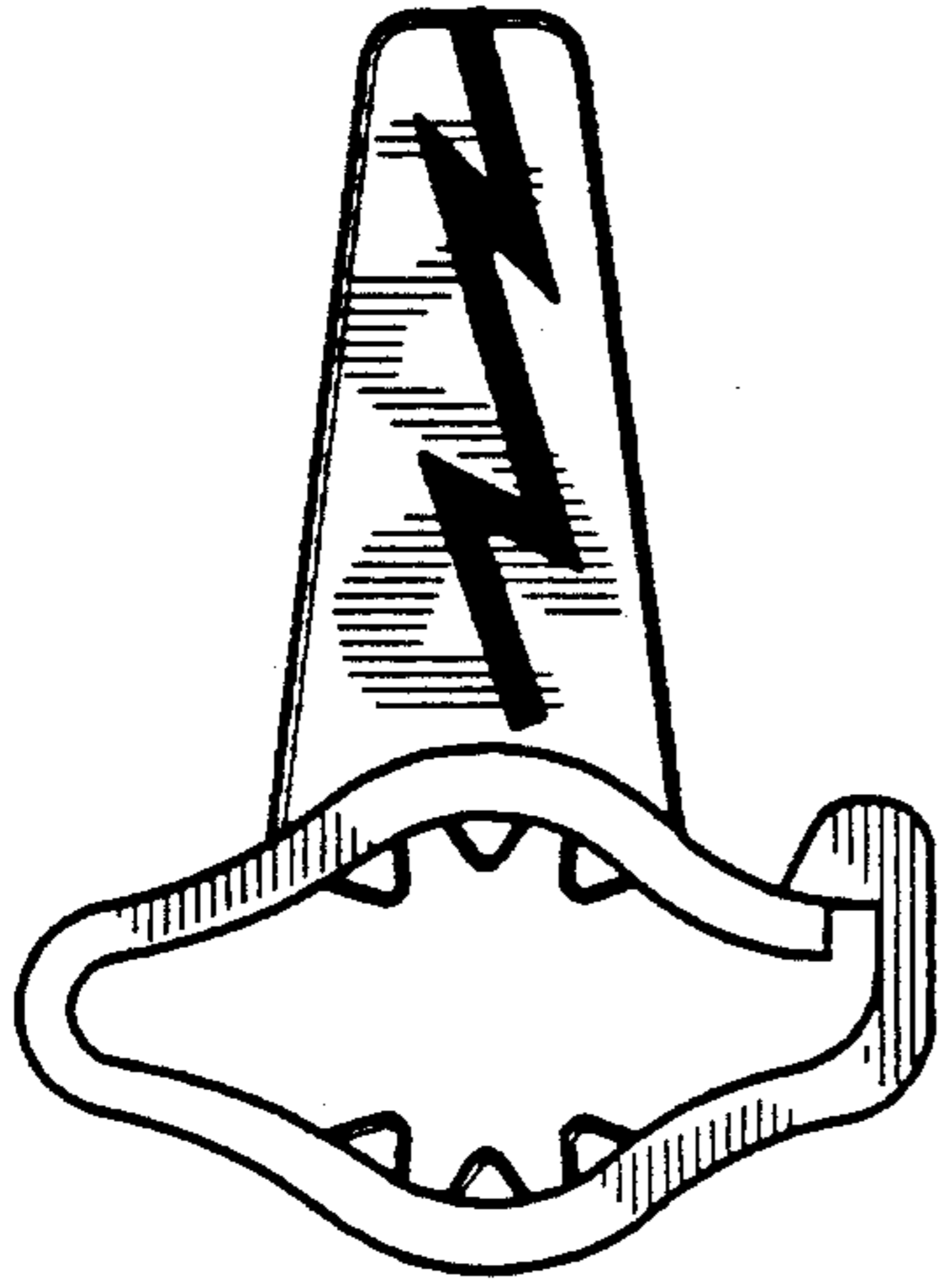

FIG. 3

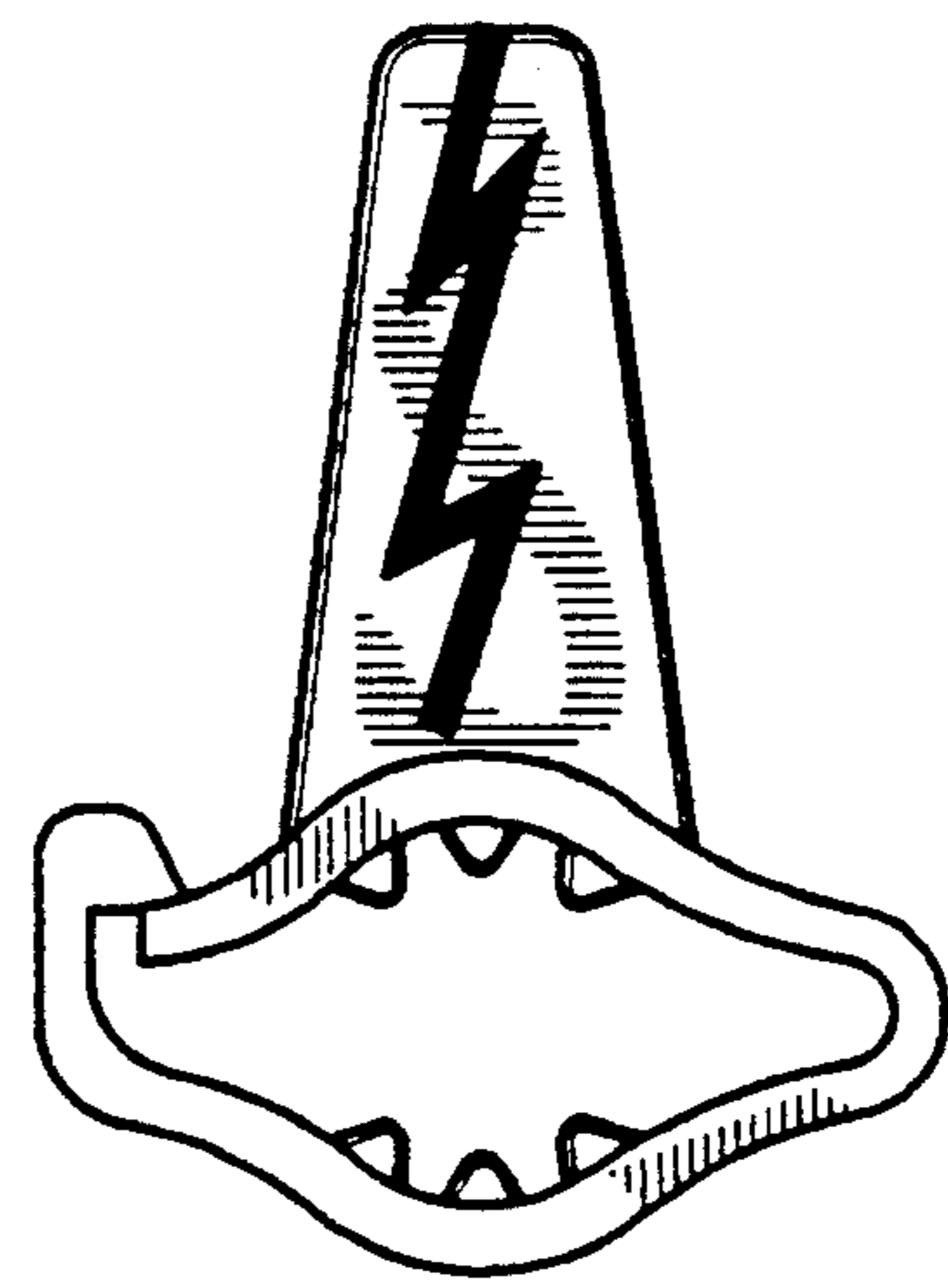

FIG. 4

FIG. 5

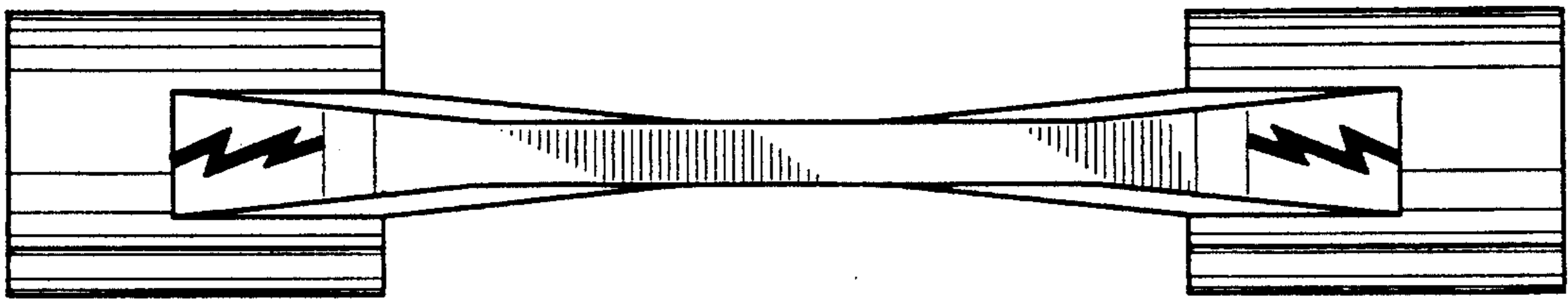

FIG. 6

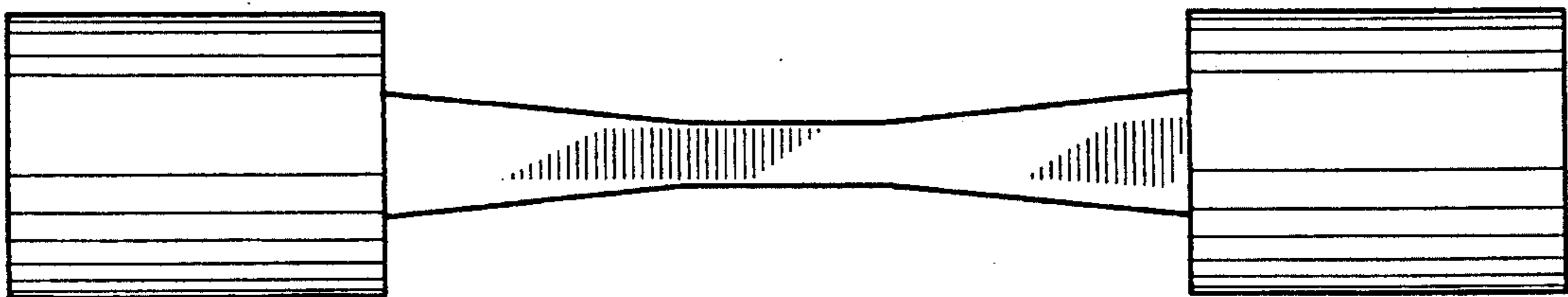

FIG. 7

