



US00D340692S

United States Patent [19]

Iijima et al.

[11] Patent Number: **Des. 340,692**

[45] Date of Patent: *** Oct. 26, 1993**

[54] **ELECTROLYTIC CAPACITOR**

[75] Inventors: **Keiji Iijima; Masashi Okazaki; Takashi Kono**, all of Tokyo, Japan

[73] Assignee: **NEC Corporation**, Tokyo, Japan

[*] Notice: The portion of the term of this patent subsequent to Jul. 20, 2009, has been disclaimed.

[**] Term: **14 Years**

[21] Appl. No.: **527,786**

[22] Filed: **May 23, 1990**

[30] **Foreign Application Priority Data**

Nov. 27, 1989 [JP] Japan 1-43240

[52] U.S. Cl. **D13/125; D13/123; D13/199**

[58] Field of Search **D13/118, 125; 361/523, 361/535, 536, 538, 539, 540; 429/178; 320/2**

[56] **References Cited**

U.S. PATENT DOCUMENTS

D. 259,423 6/1981 Root et al. D14/127
4,204,036 5/1980 Cohen et al. 429/178 X

4,232,260 11/1980 Lambkin 320/2
4,814,946 3/1989 Su 361/523

FOREIGN PATENT DOCUMENTS

2225825 11/1972 Fed. Rep. of Germany 361/523
0073610 3/1989 Japan 361/522
0291417 11/1989 Japan 361/525
0106018 4/1990 Japan 361/535

Primary Examiner—Wallace R. Burke
Assistant Examiner—Joel Sincavage
Attorney, Agent, or Firm—Sughrue, Mion, Zinn, Macpeak & Seas

[57] **CLAIM**

The ornamental design for an electrolytic capacitor, as shown.

DESCRIPTION

FIG. 1 is a front, top and right side perspective view of an electrolytic capacitor showing our new design; FIG. 2 is a front, bottom and right side perspective view thereof; FIG. 3 is a front elevational view thereof; FIG. 4 is a left side elevational view thereof; FIG. 5 is a right side elevational view thereof; FIG. 6 is a rear elevational view thereof; FIG. 7 is a top plan view thereof; and, FIG. 8 is a bottom plan view thereof.

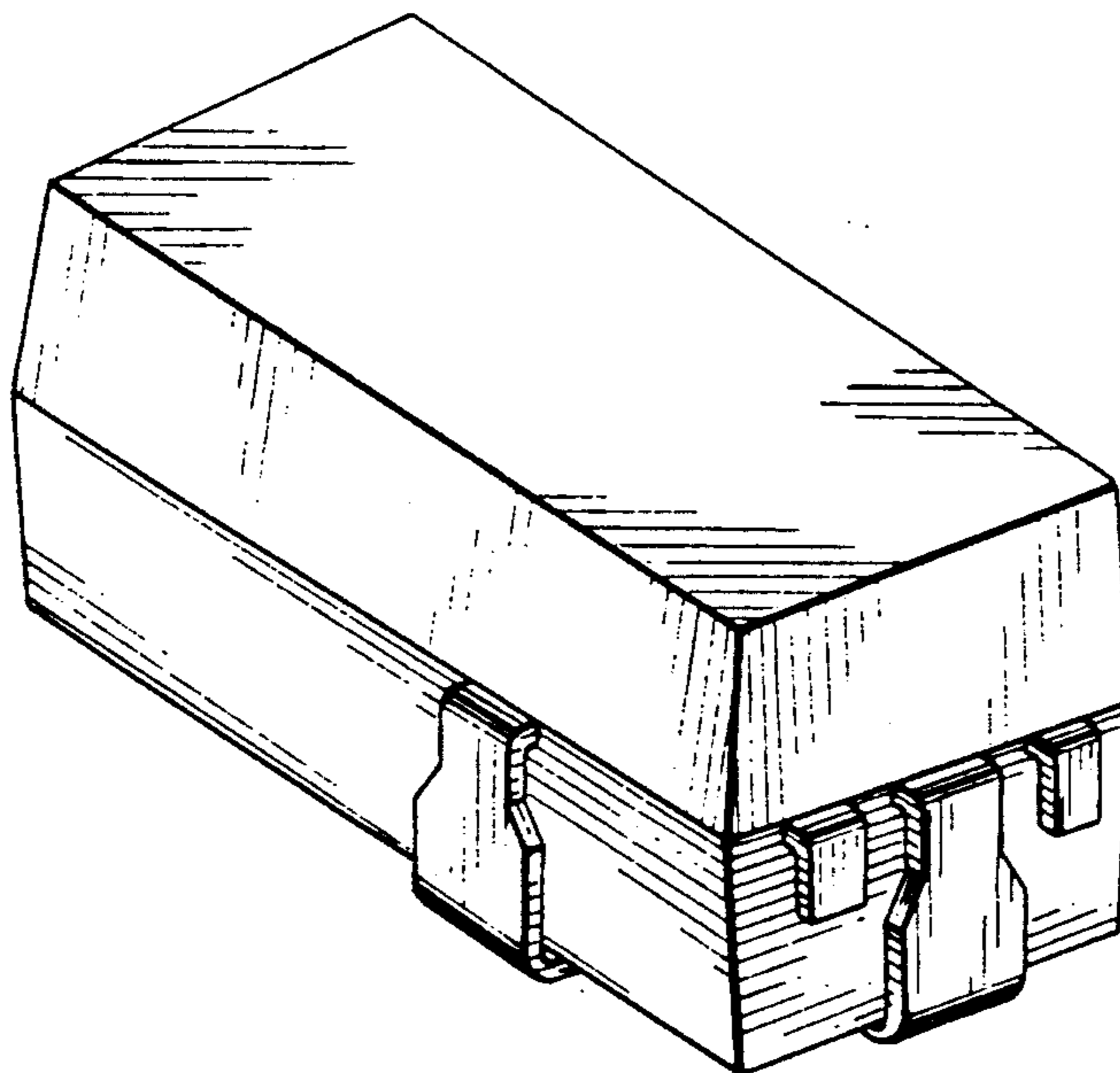

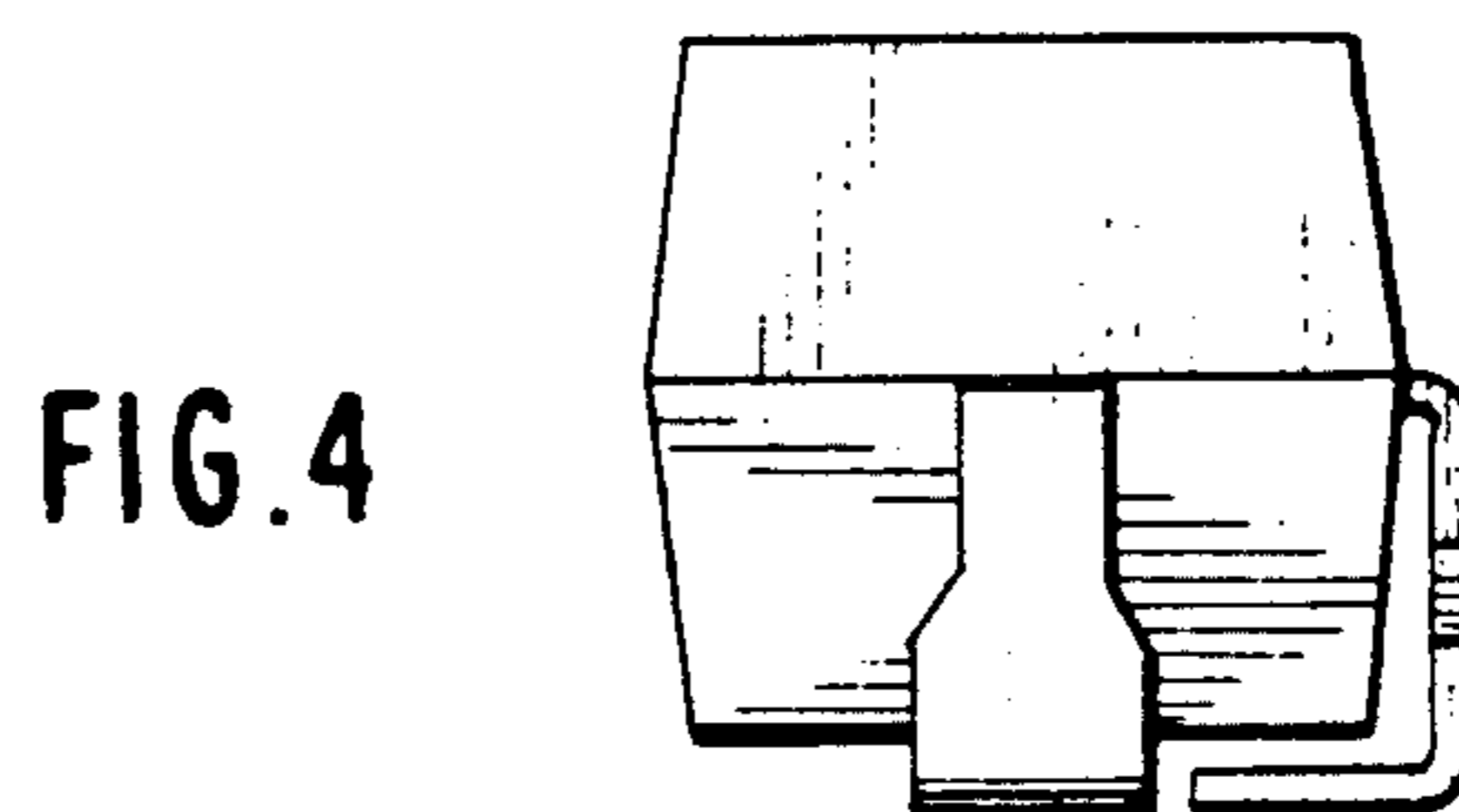
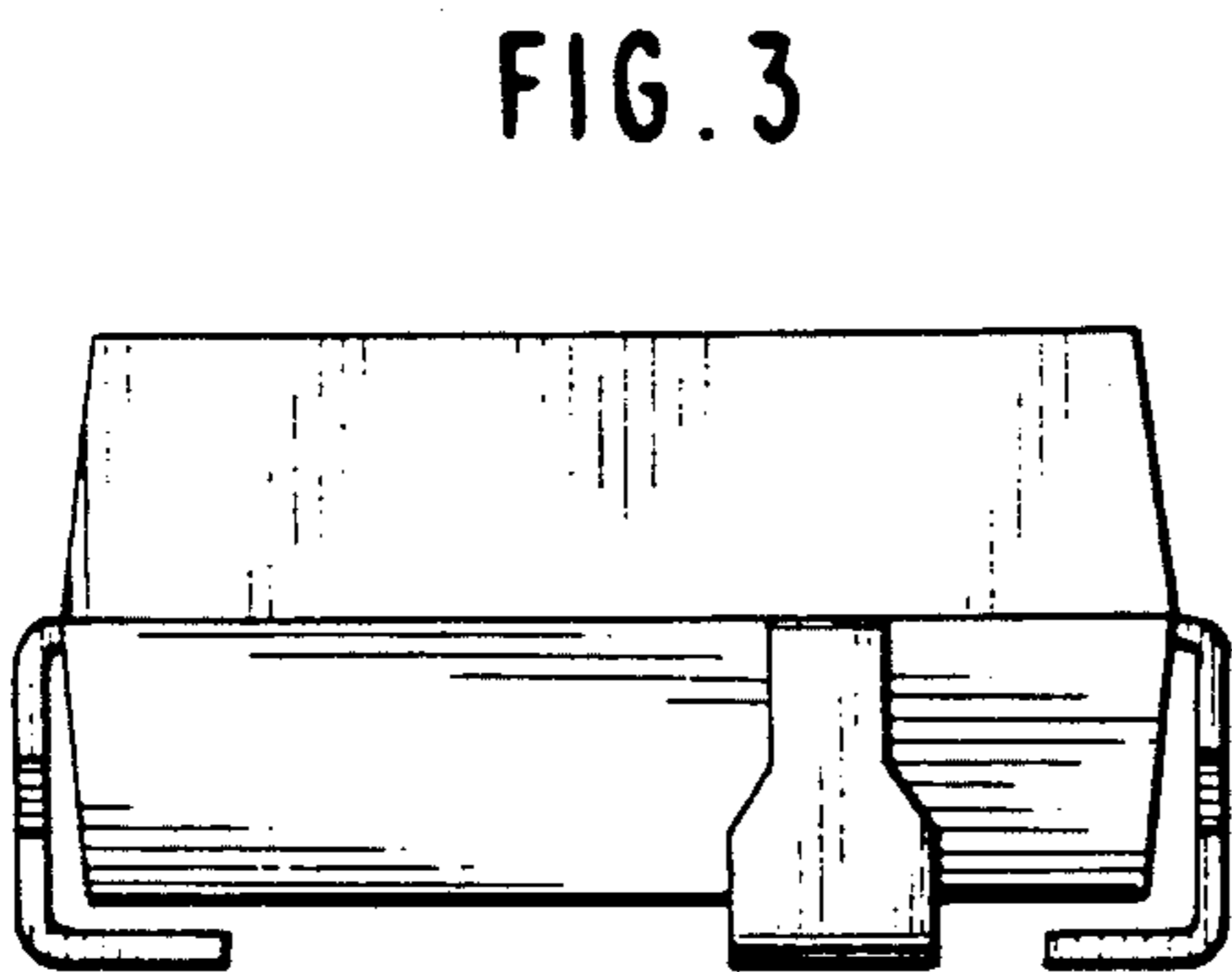
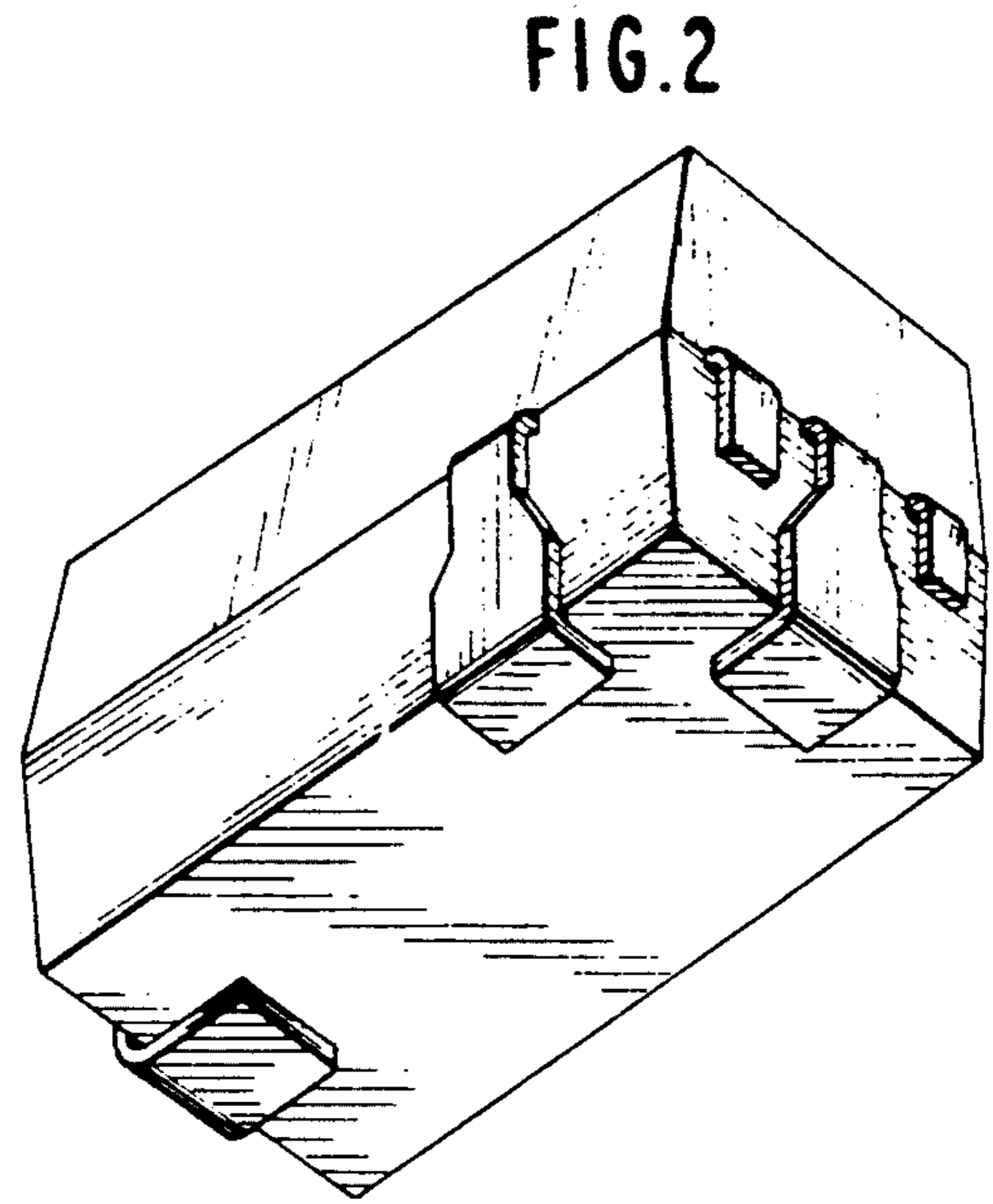
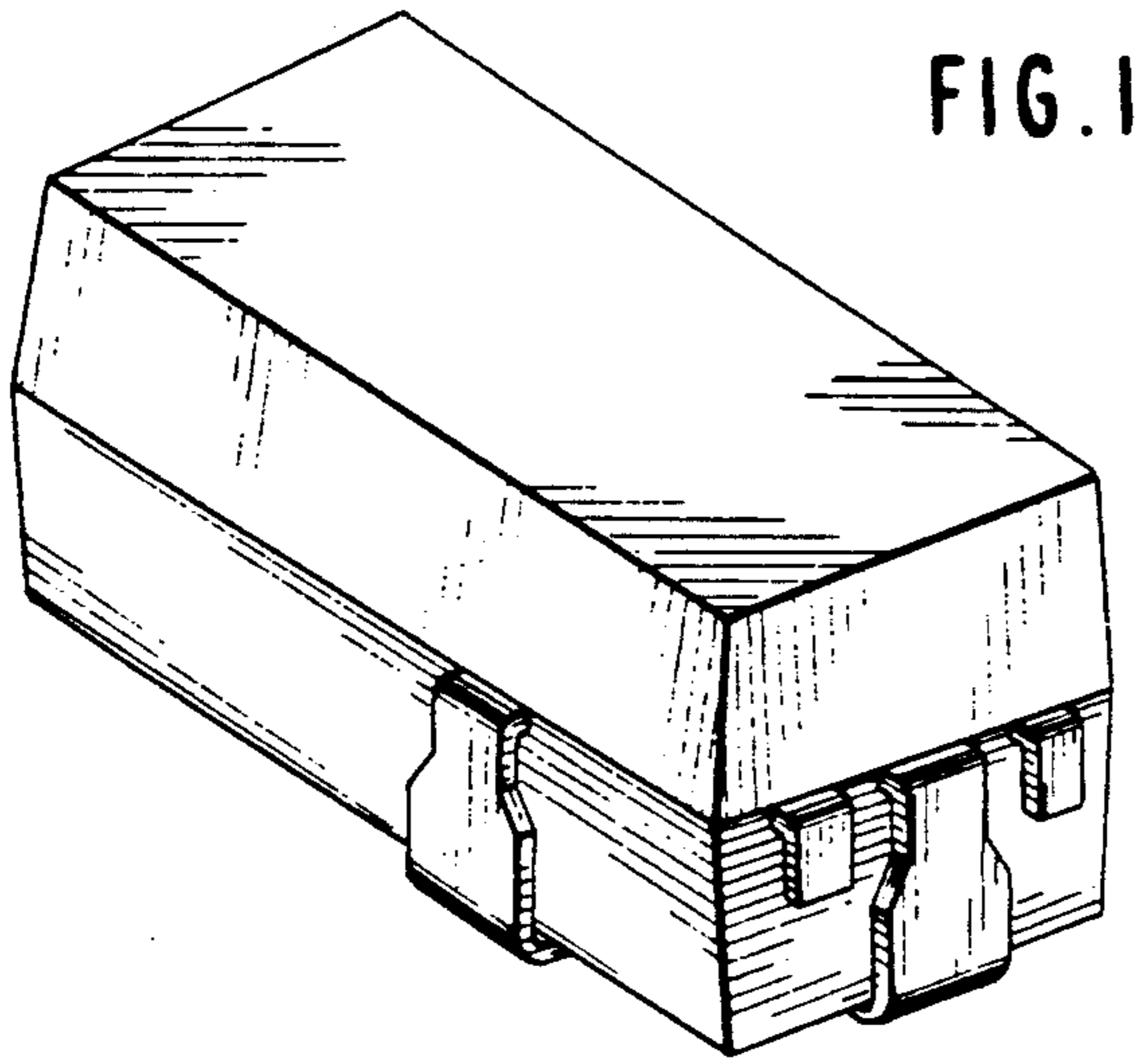

FIG. 5

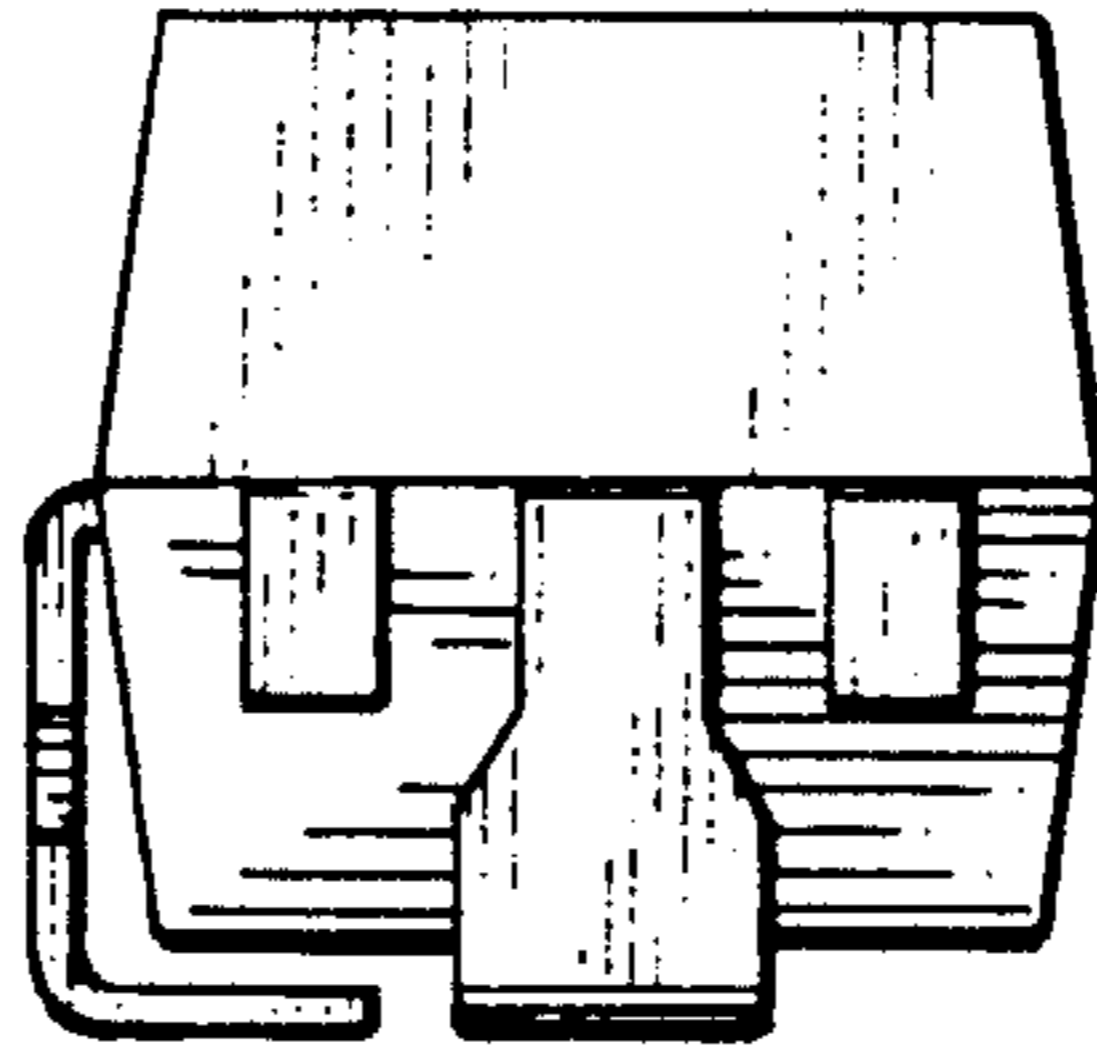

FIG. 6

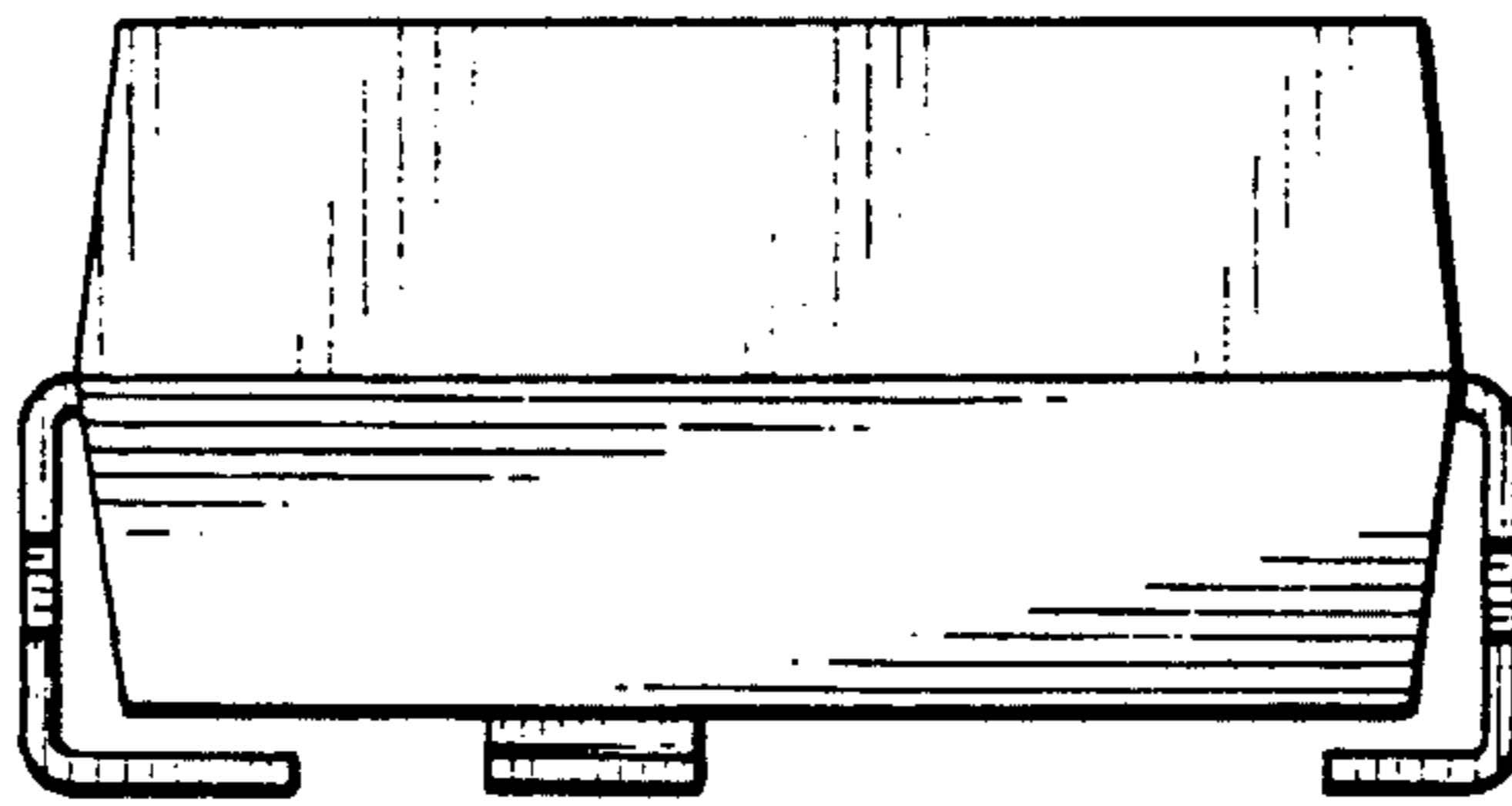

FIG. 7

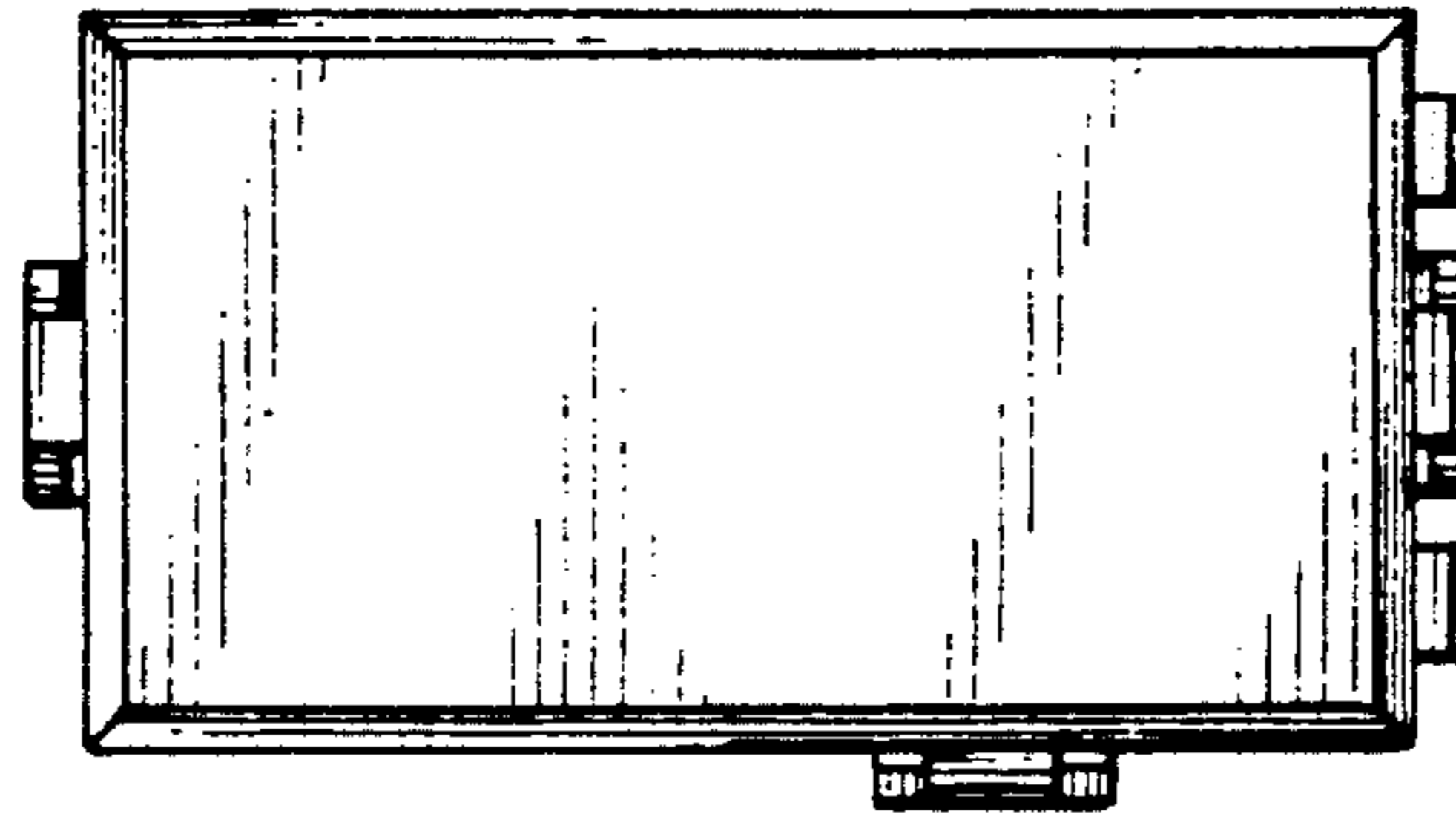

FIG. 8

