



US00D340608S

# United States Patent [19]

[11] Patent Number: Des. 340,608

Hubbard

[45] Date of Patent: \*\* Oct. 26, 1993

[54] TOOL HOLDER

[75] Inventor: Norman F. Hubbard, Scranton, Pa.

[73] Assignee: Tool Deck, Inc., Moosic, Pa.

[\*\*] Term: 14 Years

[21] Appl. No.: 855,344

[22] Filed: Mar. 23, 1992

[52] U.S. Cl. .... D6/567; D6/574

[58] Field of Search ..... D6/552, 553, 567, 569, D6/570, 574; D8/354, 373; 206/349; 211/60.1, 69, 70.6, 70.7, 70.5, 86, 87, 89, 126, 134; 248/309.1

3,187,902	6/1965	Nelson	.....	211/70.6
3,269,550	8/1966	Marcus	.....	211/87
3,603,551	9/1971	Peterson	.....	211/70.6
3,685,667	8/1972	Bell	.....	211/70.5
3,737,131	6/1973	Larson	.....	248/223
4,681,233	7/1987	Roth	.....	211/70.6

Primary Examiner—Brian N. Vinson  
Attorney, Agent, or Firm—Eckert Seamans Cherin & Mellott

### [57] CLAIM

The ornamental design for a tool holder, as shown and described.

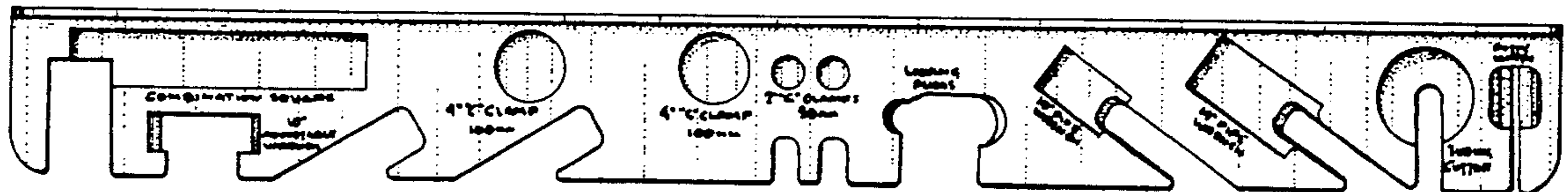
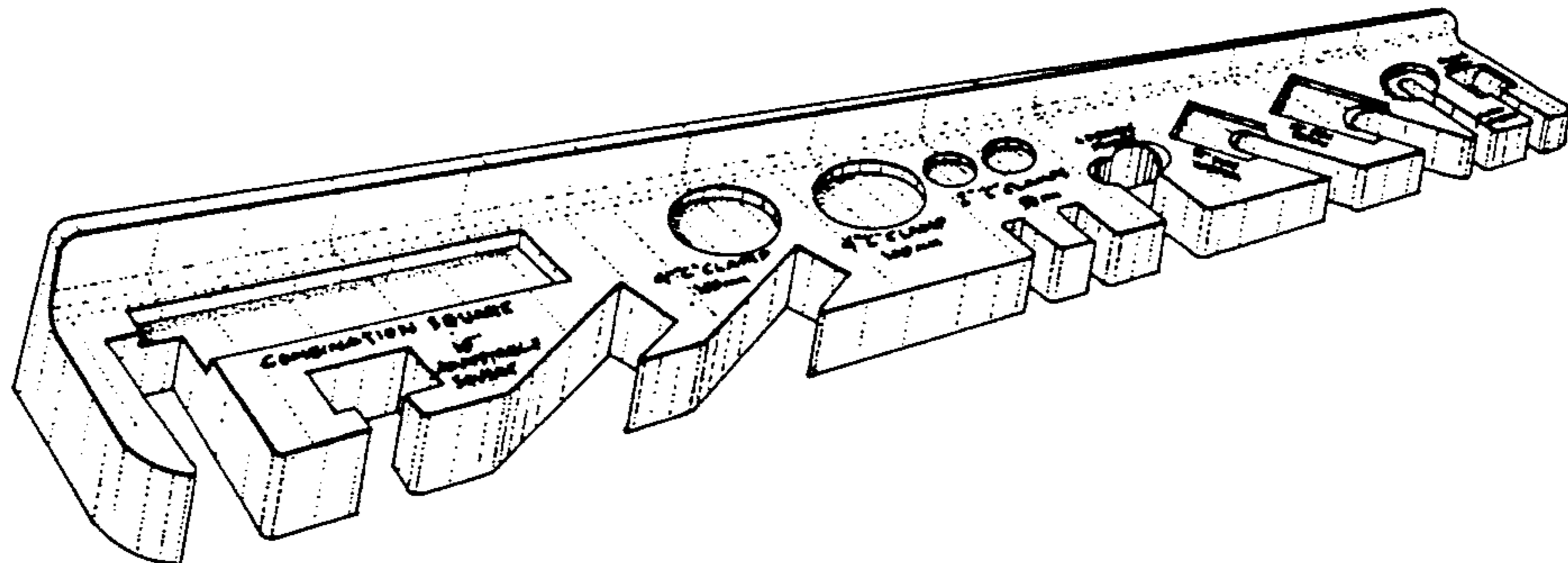
### DESCRIPTION

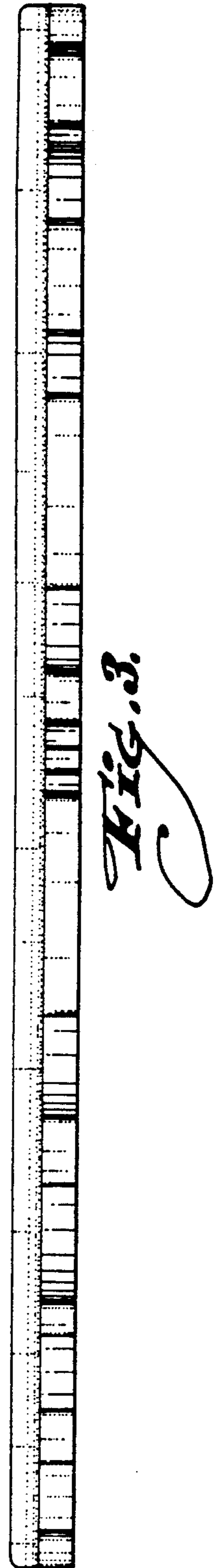
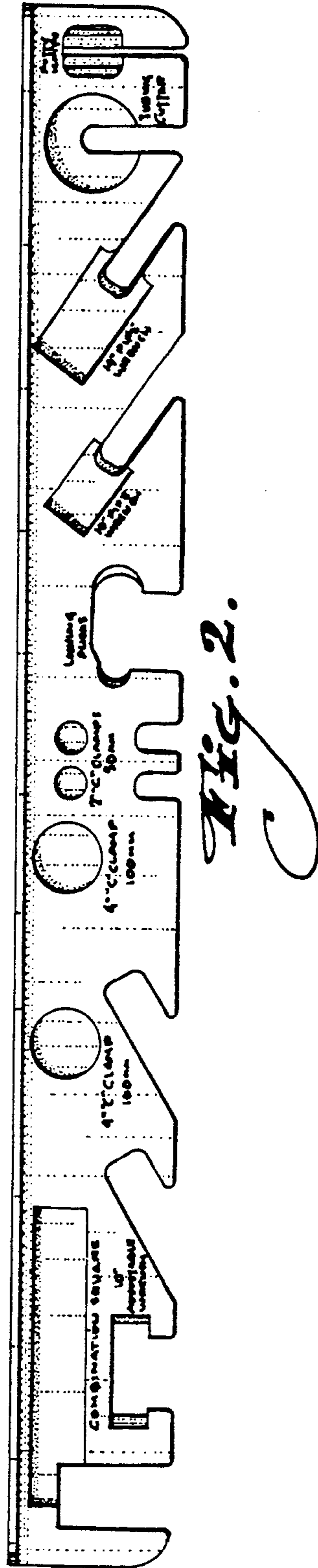
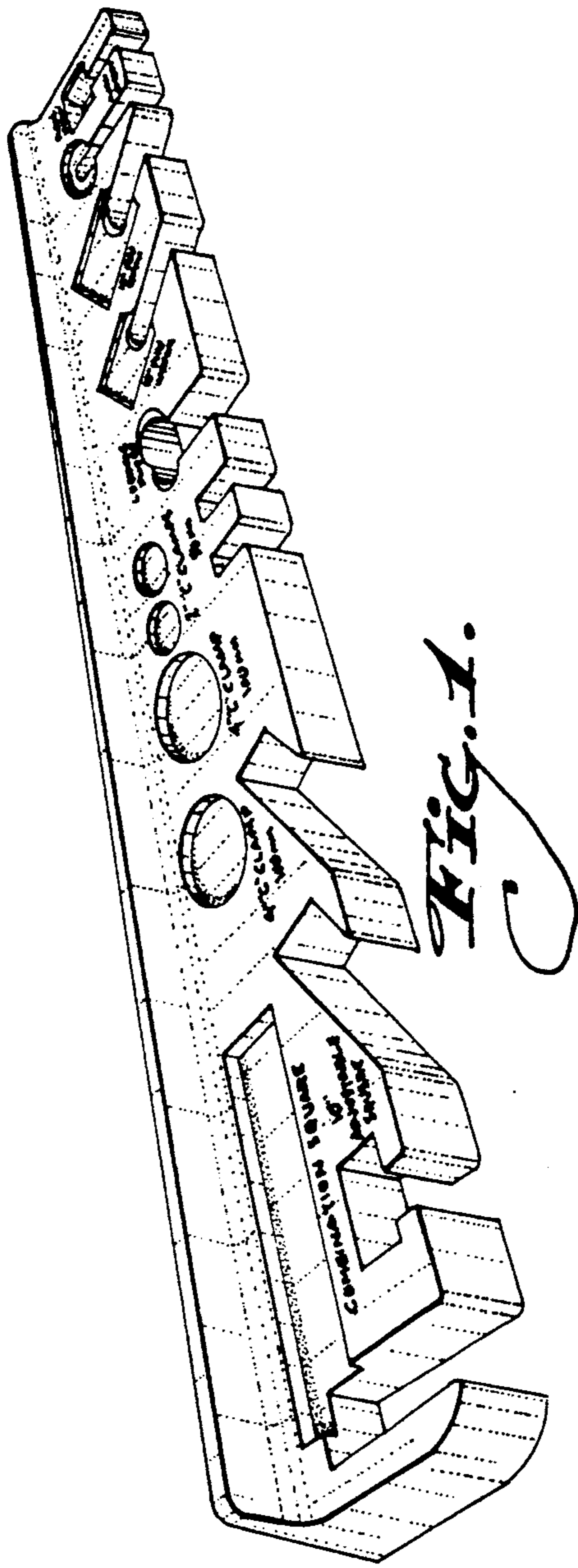
FIG. 1 is a perspective view of the tool holder of my invention;  
FIG. 2 is a top plan view thereof;  
FIG. 3 is a front view thereof;  
FIG. 4 is a bottom plan view thereof;  
FIG. 5 is a rear view thereof;  
FIG. 6 is a right-hand side view thereof; and,  
FIG. 7 is a left-hand side view thereof.

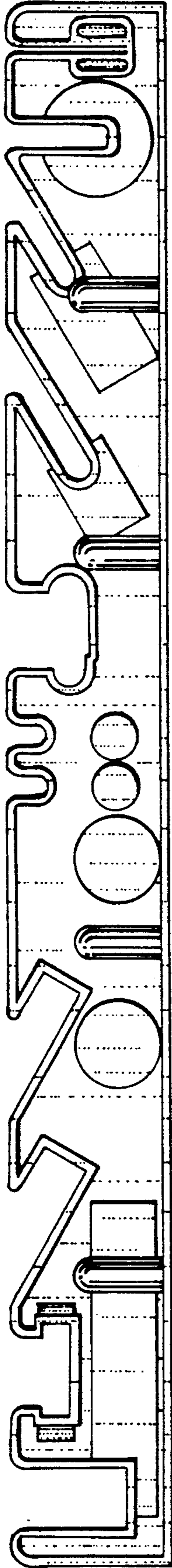
### [56] References Cited

#### U.S. PATENT DOCUMENTS

D. 251,819	5/1979	Nuttall et al.	.....	D6/569
D. 286,119	10/1986	Enquist	.....	D6/552
D. 309,687	8/1990	Embree et al.	.....	D6/553
D. 310,762	9/1990	Embree et al.	.....	D6/569
D. 323,245	1/1992	Hobson	.....	D6/553 X
2,974,804	3/1961	Maro	.....	211/70.6



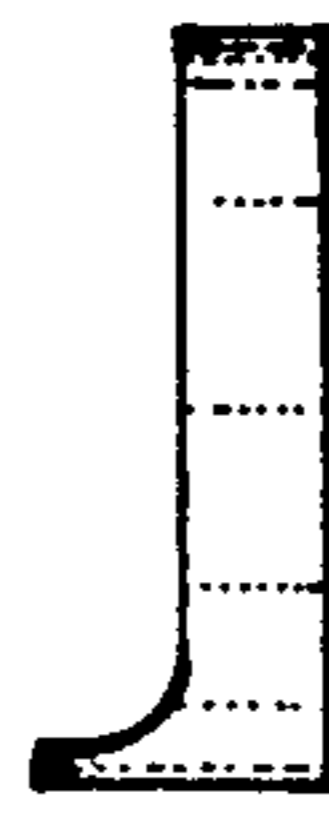




*Fig. 4.*



*Fig. 5.*



*Fig. 6.*



*Fig. 7.*