



US00D340605S

United States Patent [19]

Feigenbaum

[11] Patent Number: Des. 340,605

[45] Date of Patent: ** Oct. 26, 1993

[54] DISPENSER FOR LIQUID SOAP

[75] Inventor: Robert Feigenbaum, Neuried, Fed. Rep. of Germany

[73] Assignee: Ada Hotelcosmetic GmbH, Kehl-Bodersweiler, Fed. Rep. of Germany

[**] Term: 14 Years

[21] Appl. No.: 845,430

[22] Filed: Mar. 4, 1992

[30] Foreign Application Priority Data

Sep. 6, 1991 [DE] Fed. Rep. of Germany M9106413.9

[52] U.S. Cl. D6/545

[58] Field of Search D6/542-545; 222/94, 105, 129, 135, 156, 173, 180-181, 185, 630-631; 221/282-286

[56] References Cited

U.S. PATENT DOCUMENTS

D. 257,086	8/1988	Paphis	D6/544
D. 300,193	3/1989	Vigrot	D6/542
D. 333,063	2/1993	Podesta-Zurke	D6/544 X
2,965,267	12/1960	Darr	222/181 X

Primary Examiner—Brian N. Vinson
Attorney, Agent, or Firm—Peter K. Kontler

[57] CLAIM

The ornamental design for a dispenser for liquid soap, as shown and described.

DESCRIPTION

FIG. 1 is a top, front, and right side perspective view of a dispenser for liquid soap showing my new design; FIG. 2 is a front elevational view thereof; FIG. 3 is a left-hand side elevational view thereof; FIG. 4 is a rear elevational view thereof; FIG. 5 is a top plan view thereof; and, FIG. 6 is a bottom plan view thereof. The right-hand side is a mirror image of the left-hand side of the dispenser.

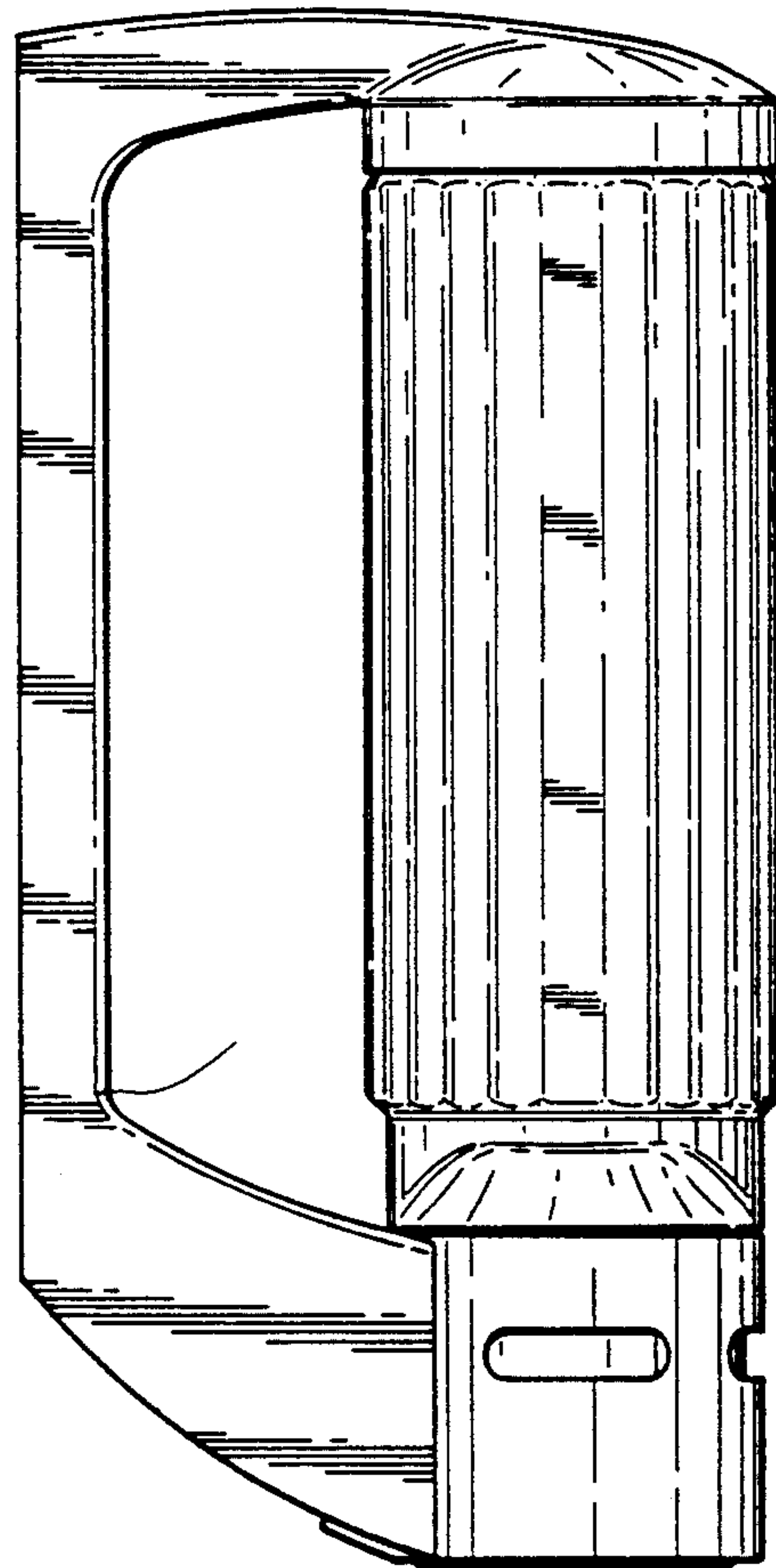
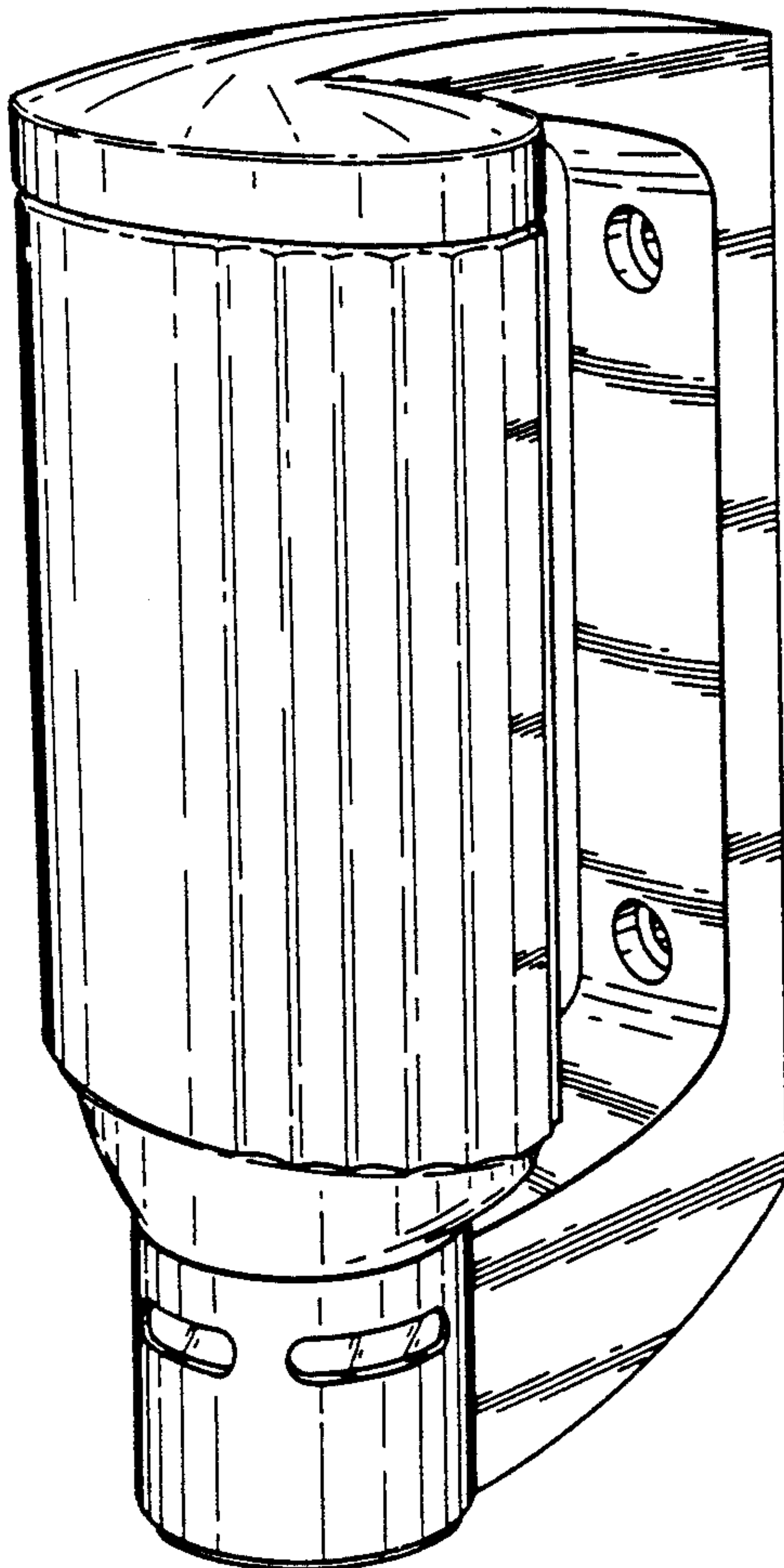

FIG. 1

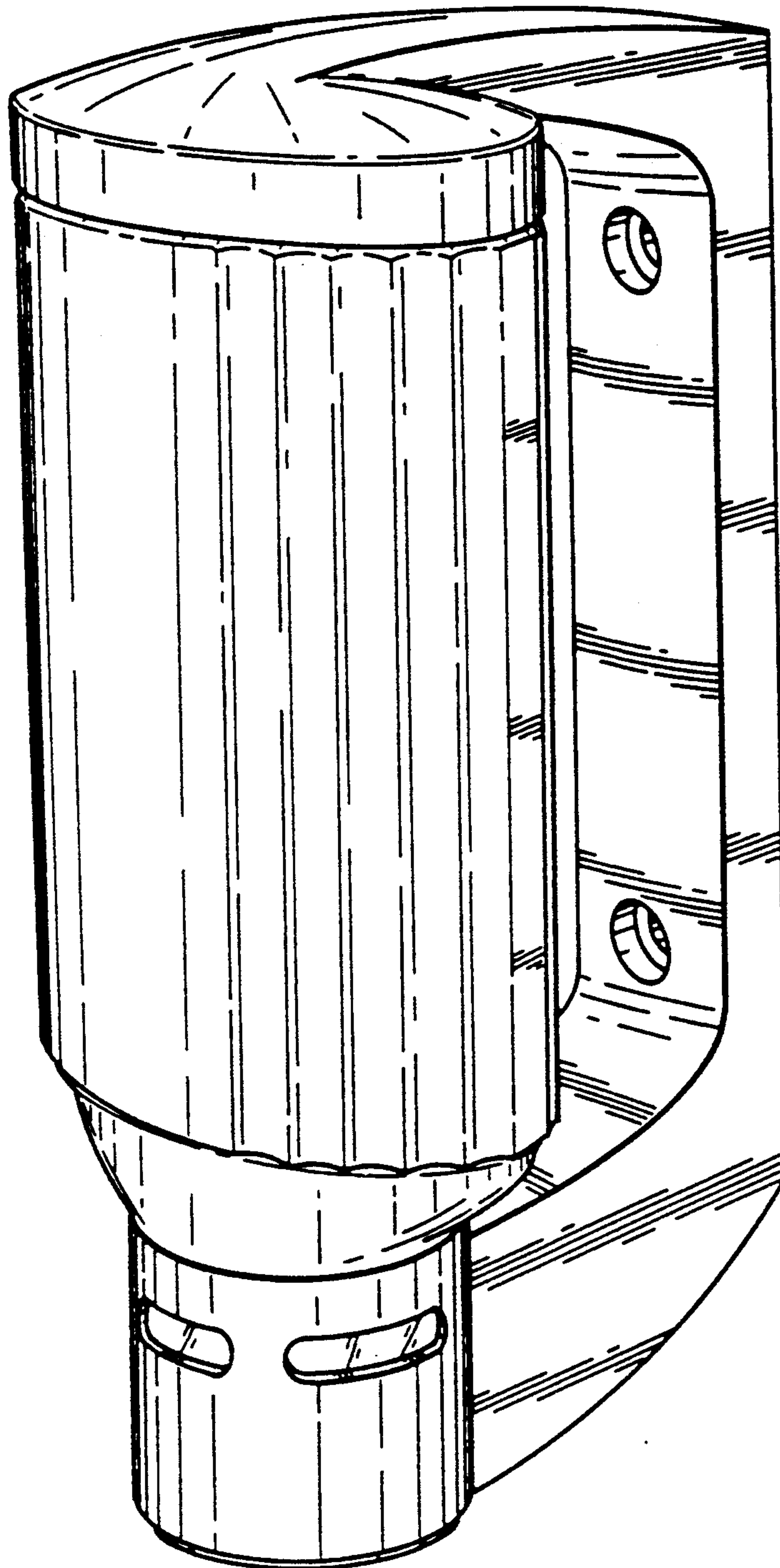

FIG. 2

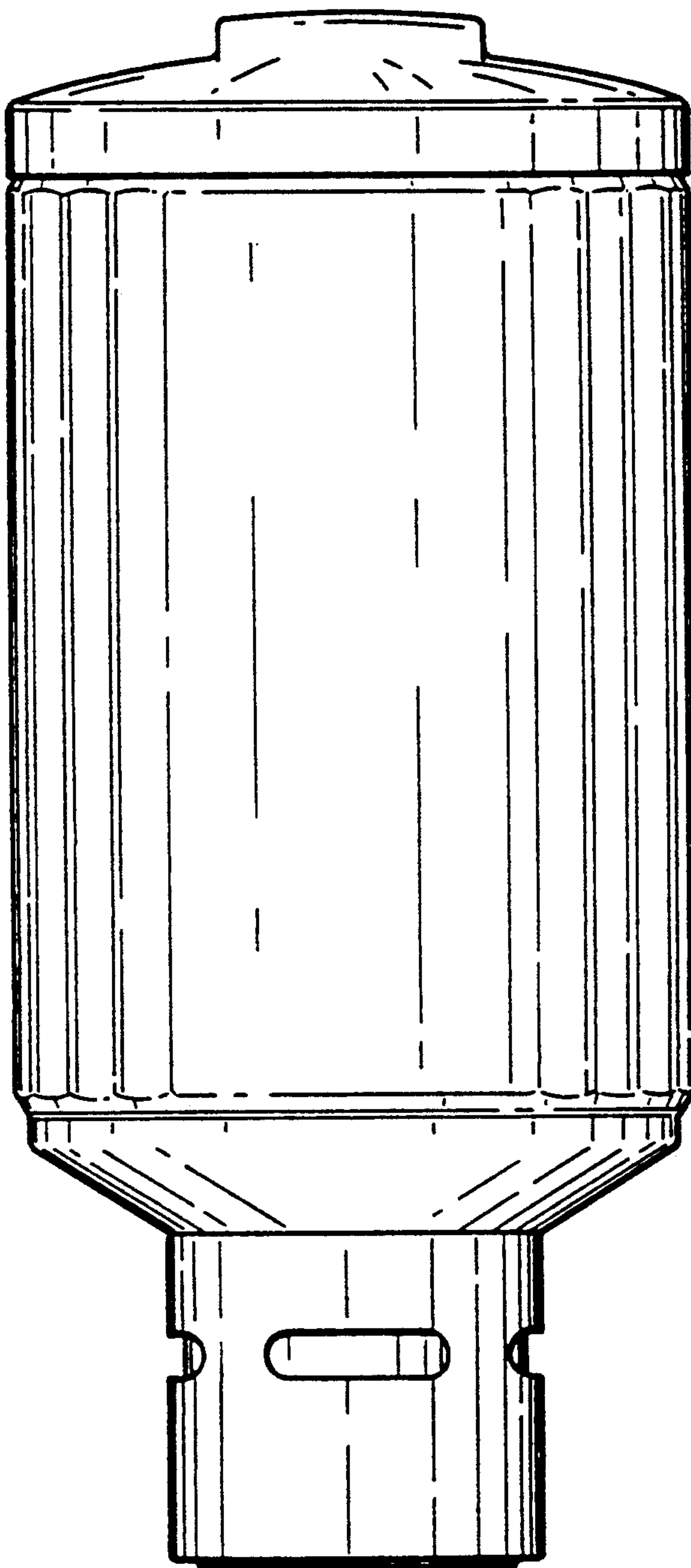

FIG. 3

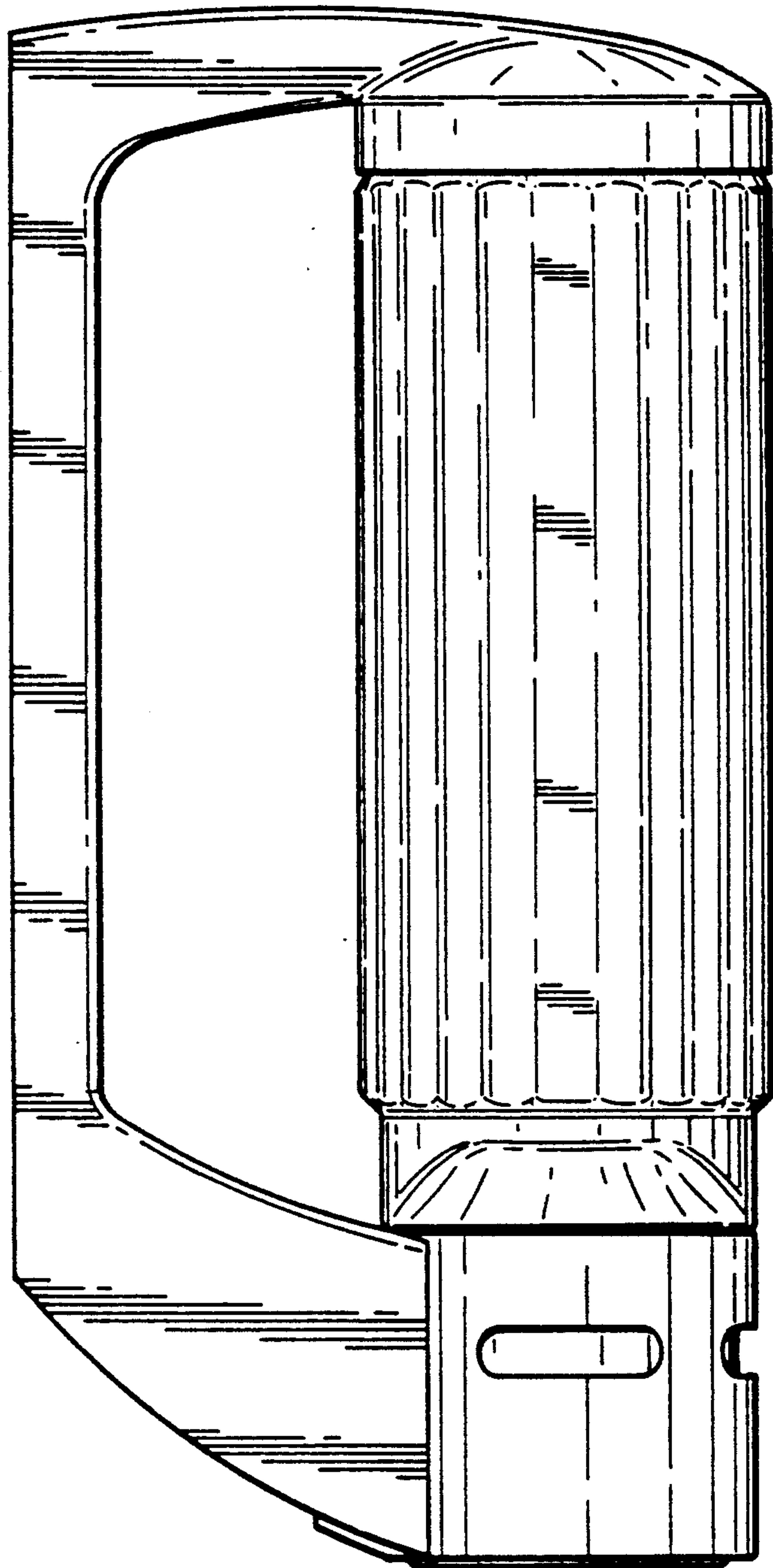
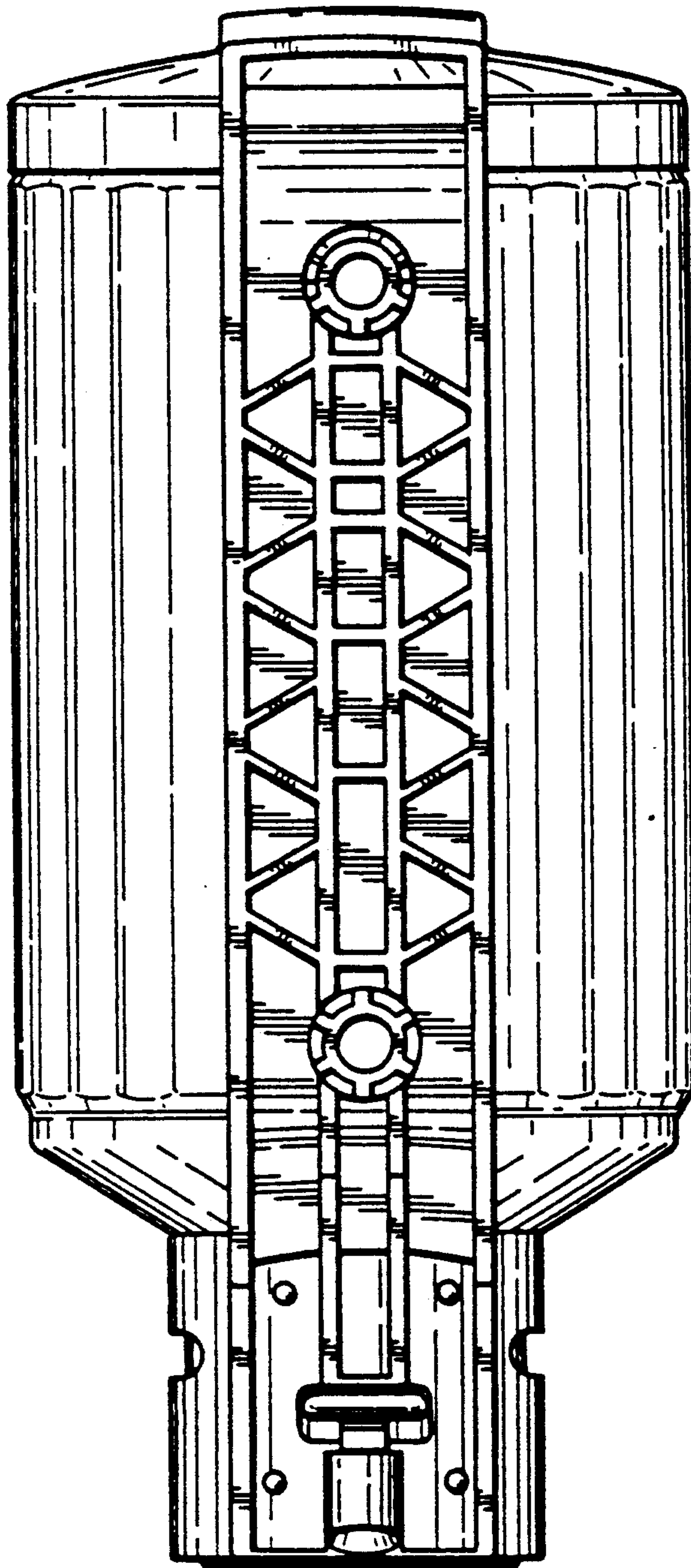

FIG. 4



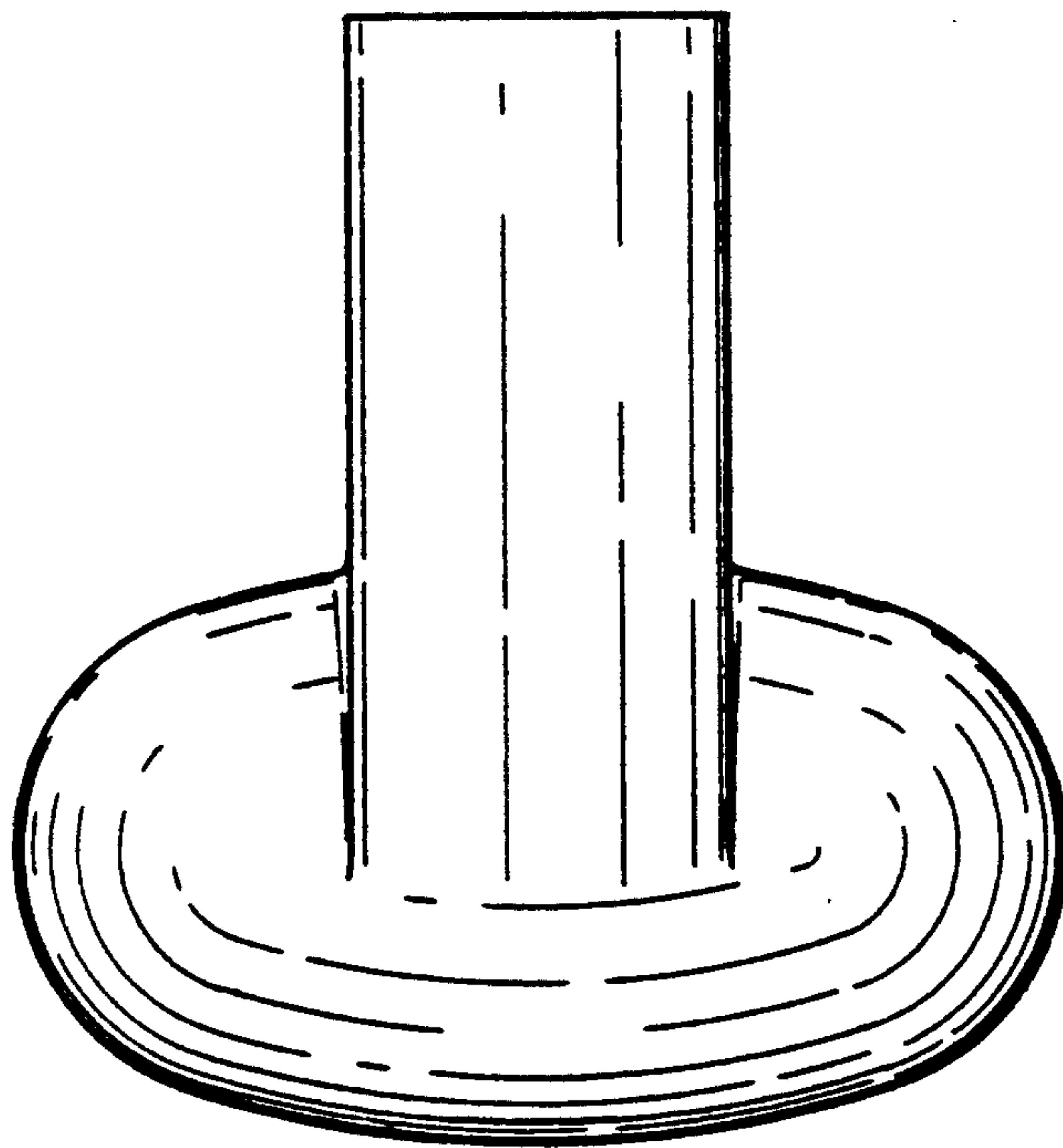

FIG. 5

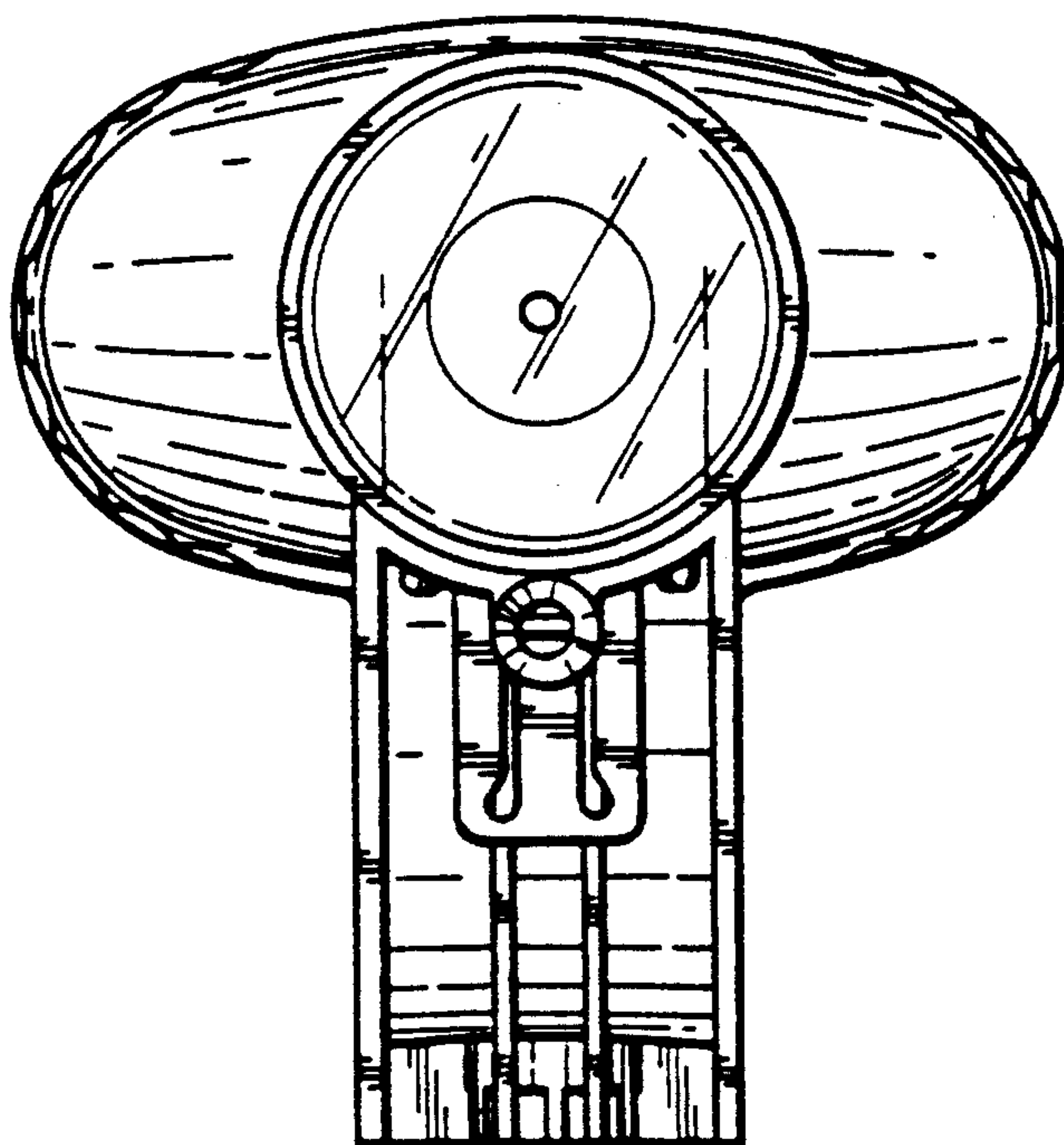

FIG. 6