



US00D340592S

# United States Patent [19]

[11] Patent Number: **Des. 340,592**

Hess

[45] Date of Patent: **\*\* Oct. 26, 1993**

[54] **CHAIR FRAME**

[75] Inventor: **Stephen C. Hess**, Birmingham, Ala.

[73] Assignee: **Winston Furniture Company**,  
Birmingham, Ala.

[\*\*] Term: **14 Years**

[21] Appl. No.: **795,629**

[22] Filed: **Nov. 21, 1991**

[52] U.S. Cl. .... **D6/370; D6/379**

[58] Field of Search ..... **D6/334, 370, 371, 372,  
D6/373, 374, 375, 376, 379, 380, 500, 501, 502;  
297/219, 445, 446**

D. 298,787 12/1988 Greene .  
D. 309,223 7/1990 Lubke .  
D. 314,474 2/1991 Schwartz .  
2,135,833 11/1938 Obermann .

### OTHER PUBLICATIONS

Brown Jordan, Mauna Kea chair #1450-2209 at top right.

*Primary Examiner*—Alan P. Douglas  
*Assistant Examiner*—Gary D. Watson  
*Attorney, Agent, or Firm*—Bell, Seltzer, Park & Gibson

### [57] CLAIM

The ornamental design for a chair frame, as shown and described.

[56] **References Cited**

#### U.S. PATENT DOCUMENTS

- D. 100,182 6/1936 Terker ..... D6/379
- D. 263,525 3/1982 Colby .
- D. 268,721 4/1983 Jernigan .
- D. 277,908 3/1985 Lüsberg .
- D. 282,418 2/1986 Lewis .
- D. 285,753 9/1986 Zola .
- D. 286,472 11/1986 Arthur, Jr. .
- D. 286,826 11/1986 Colby .
- D. 287,437 12/1986 Frinier et al. .
- D. 289,349 4/1987 Vanderminden .
- D. 291,632 9/1987 Zola .
- D. 296,625 7/1988 Mulhauser .

### DESCRIPTION

FIG. 1 is a perspective view of a chair frame which illustrates the new design;  
FIG. 2 is a side elevation view thereof;  
FIG. 3 is a top plan view thereof; and  
FIG. 4 is a front elevation view thereof;  
FIG. 5 is a rear elevation view thereof;  
FIG. 6 is an enlarged sectional view taken along line 6—6 of FIG. 2;  
FIG. 7 is an enlarged sectional view taken along line 7—7 of FIG. 2; and,  
FIG. 8 is an enlarged sectional view taken along line 8—8 of FIG. 3.

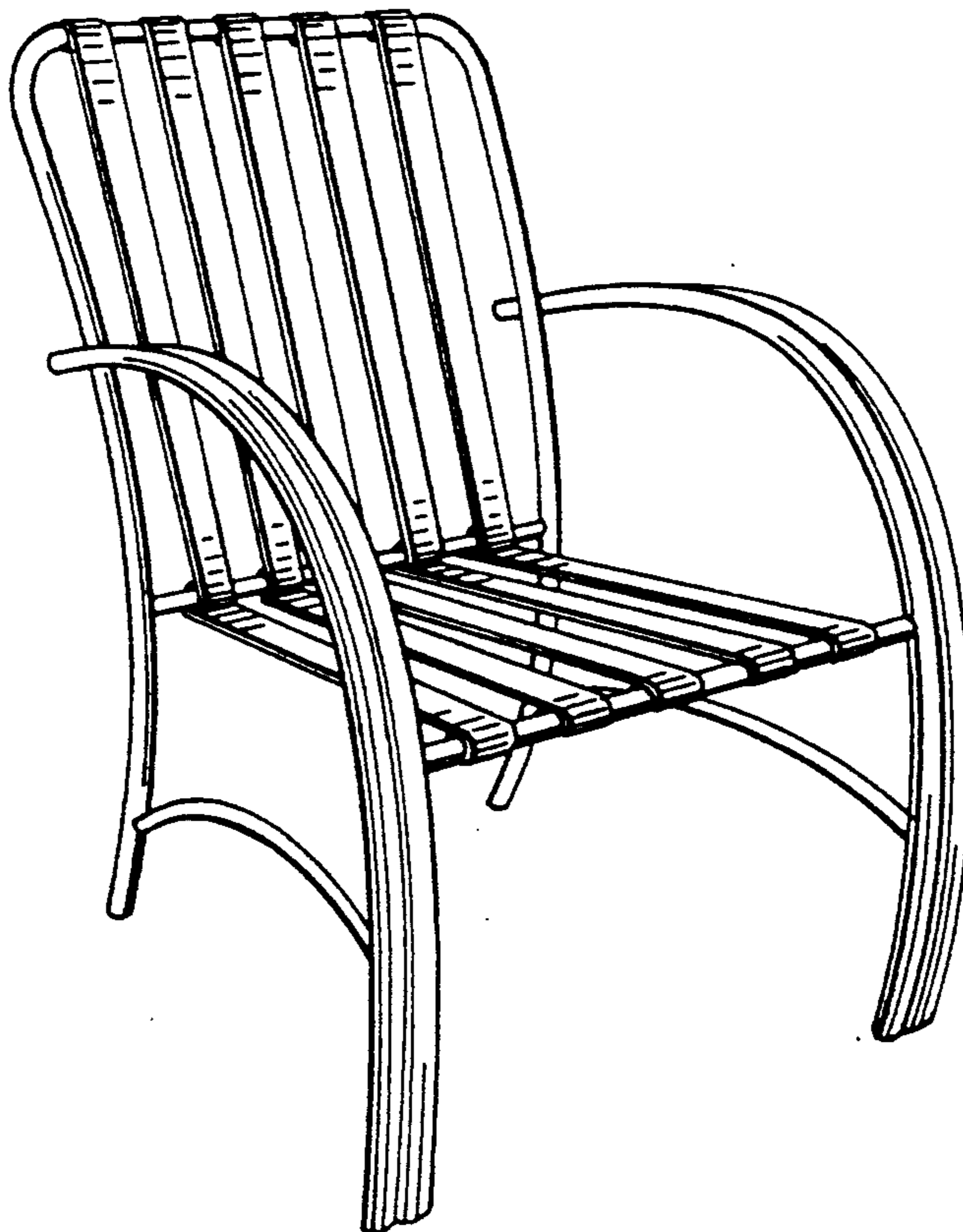

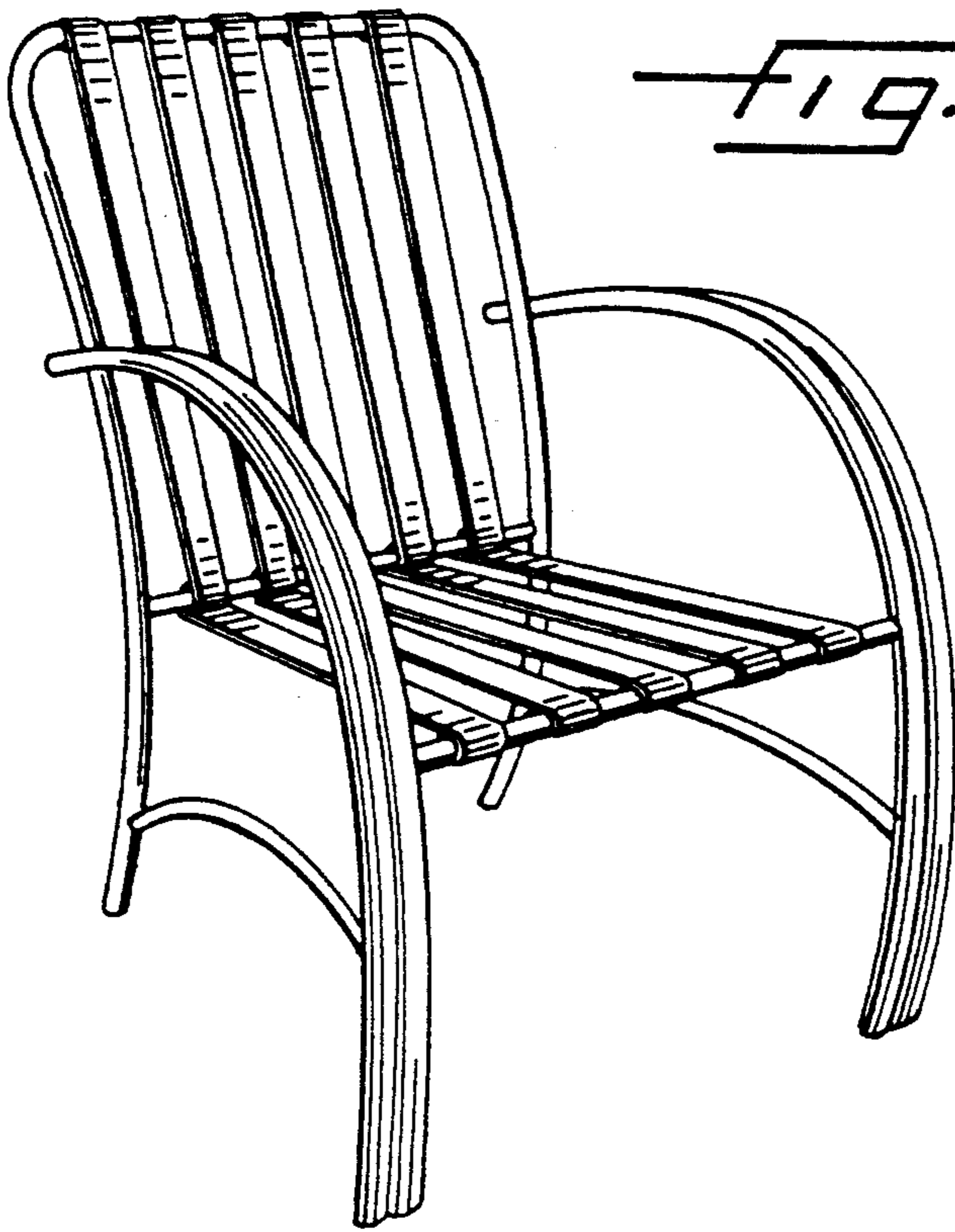

FIG. 1.

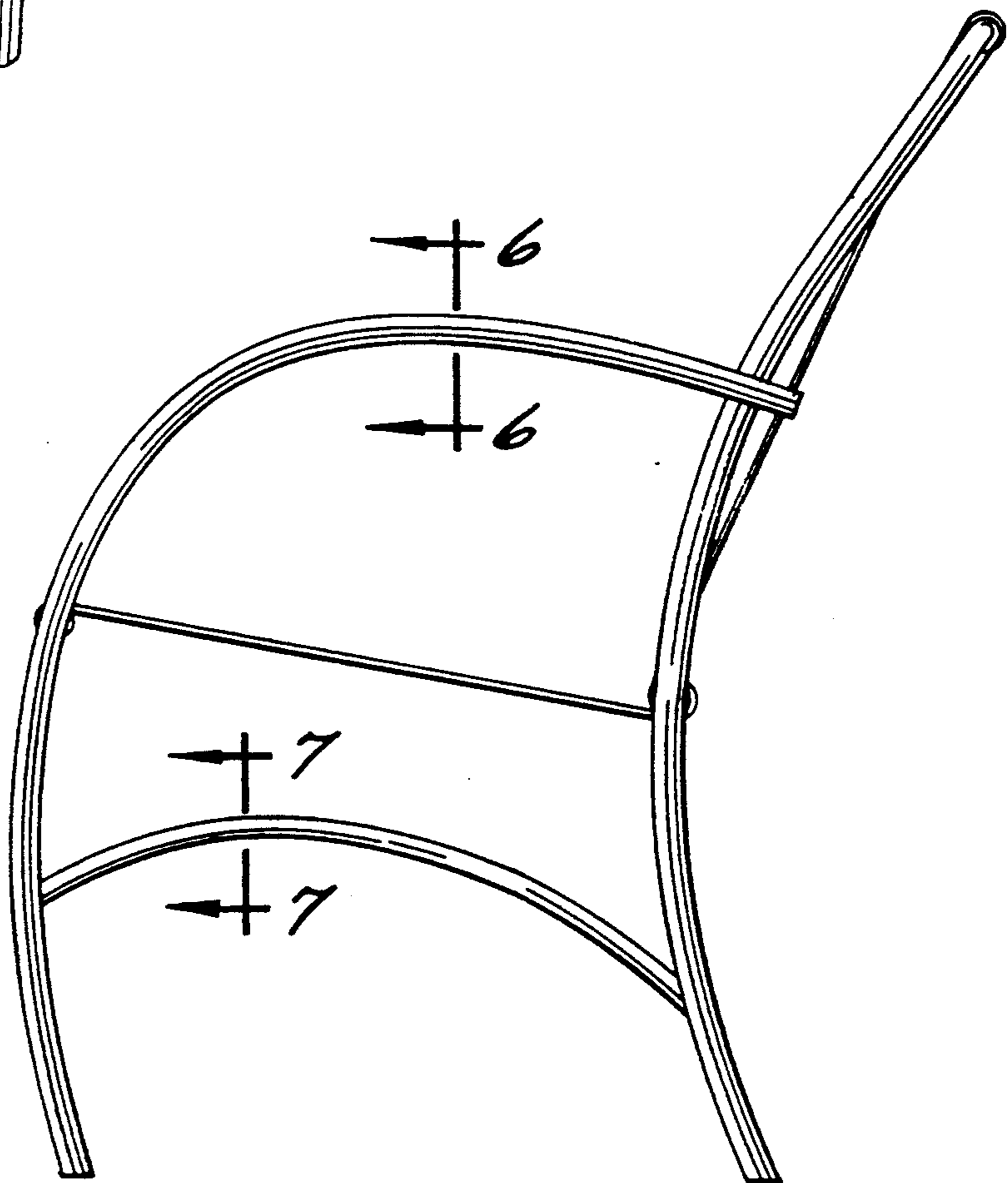

FIG. 2.

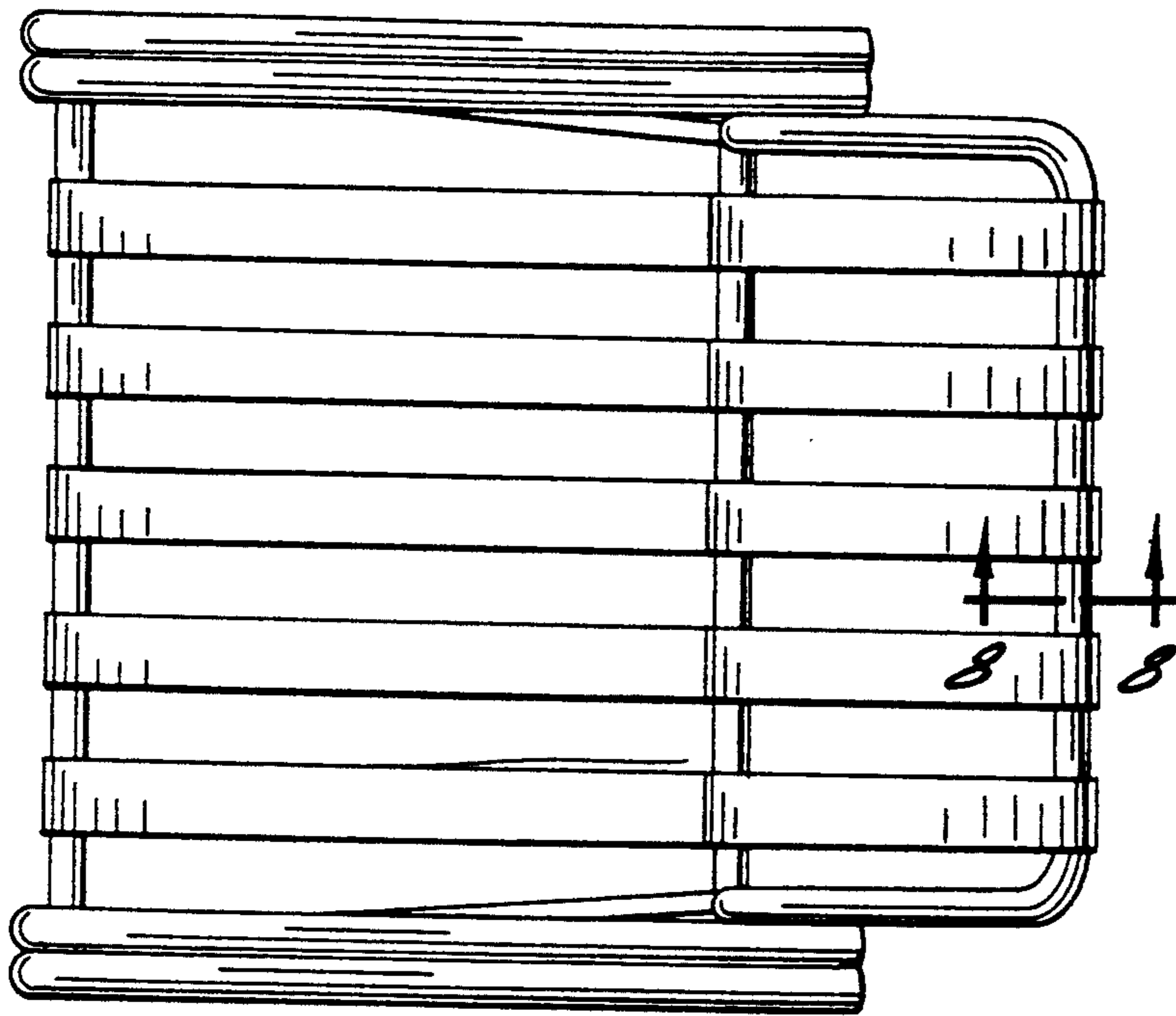

FIG. 3.

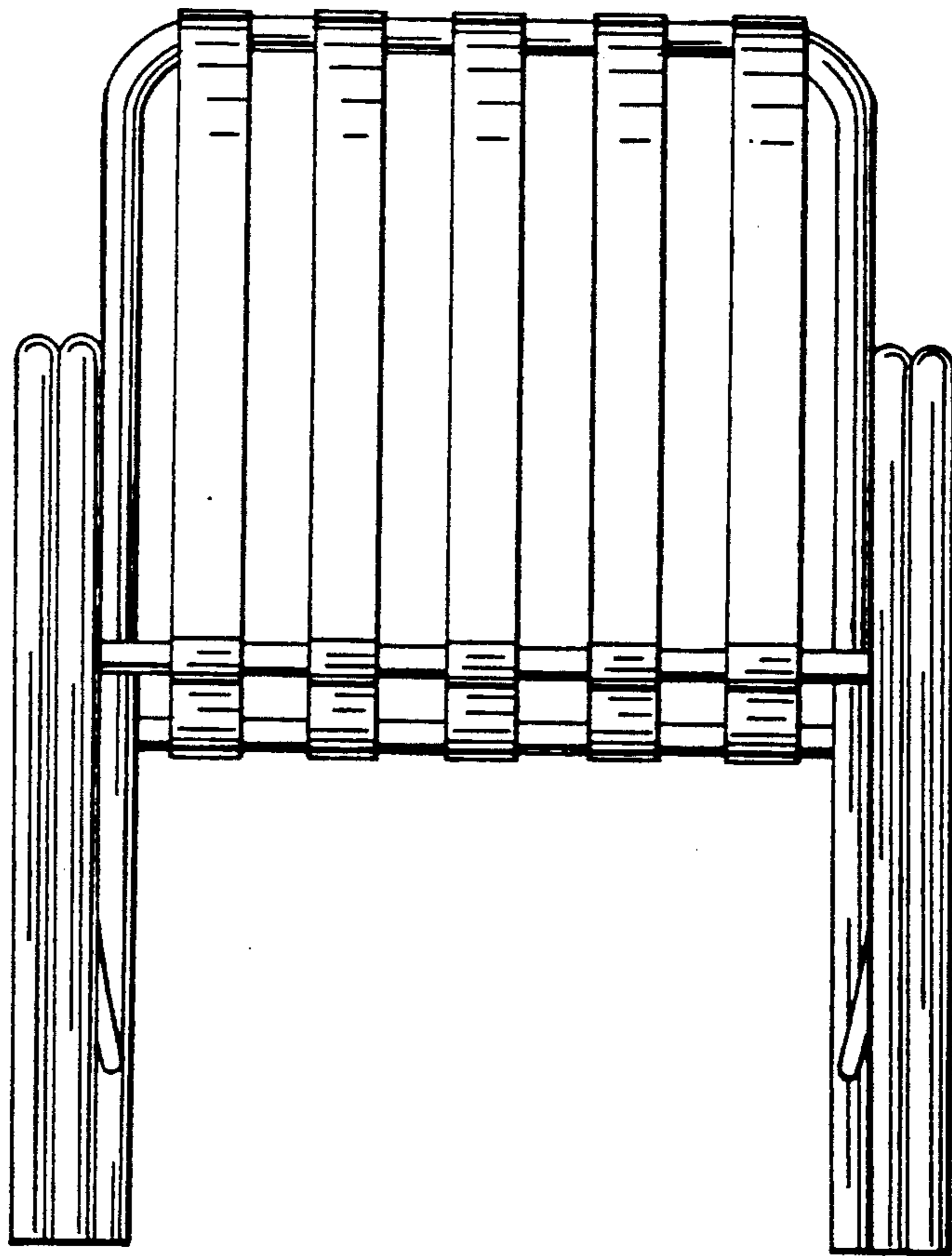

FIG. 4.

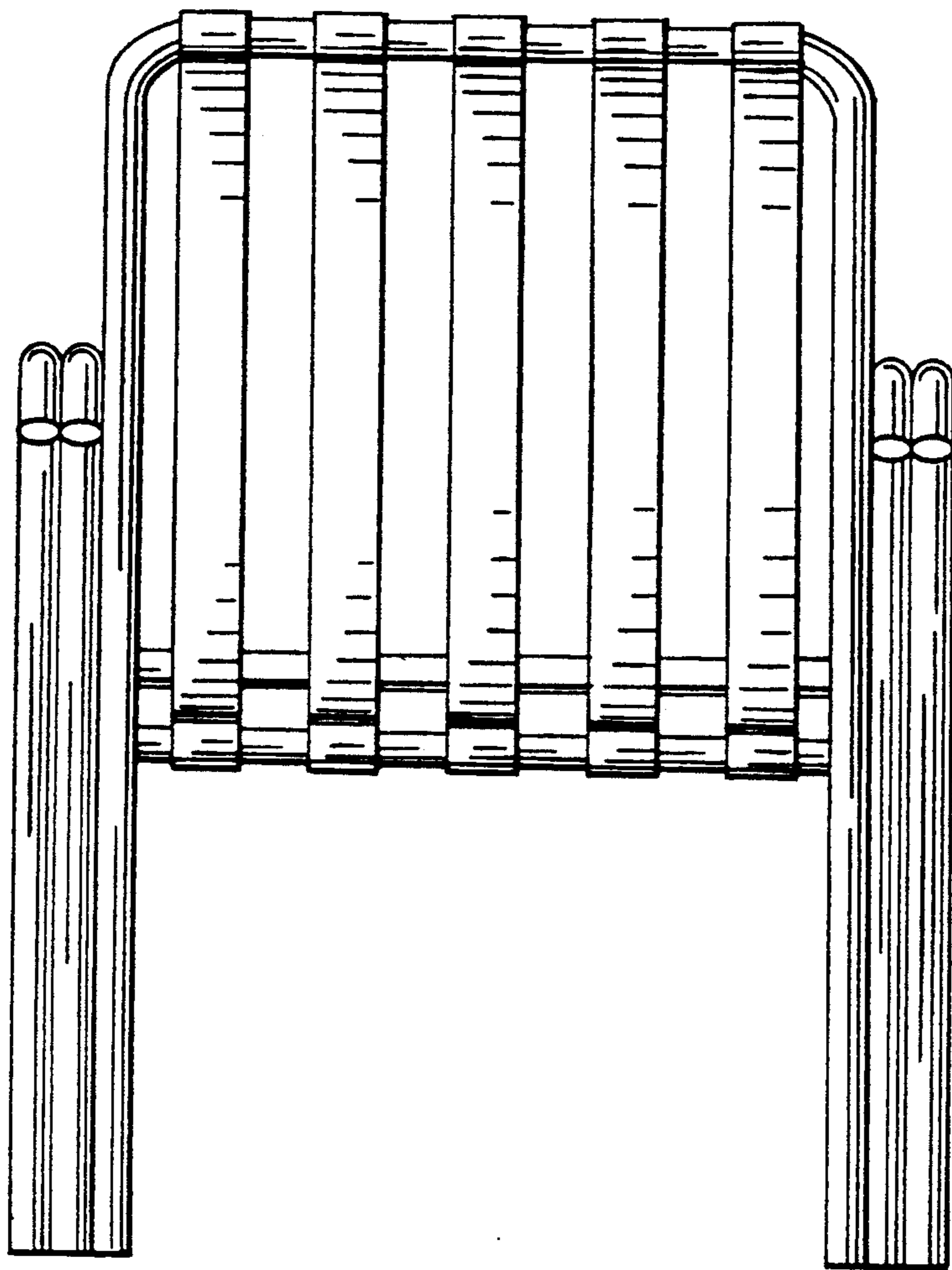

FIG. 5.

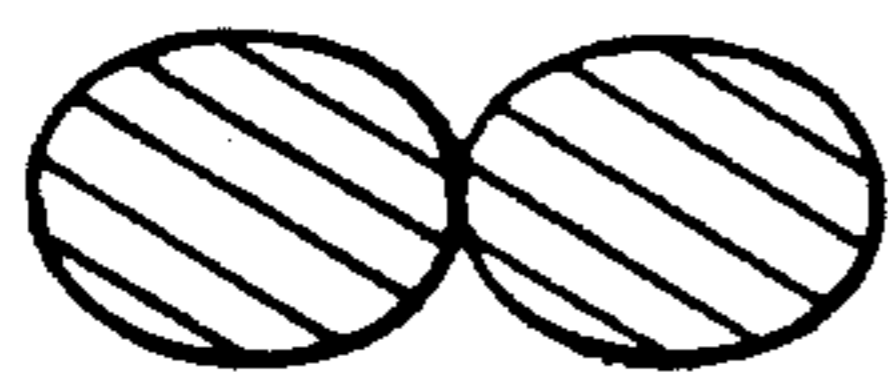

FIG. 6.



FIG. 7.



FIG. 8.