



US00D340575S

# United States Patent [19]

[11] Patent Number: **Des. 340,575**

Suwa

[45] Date of Patent: **\*\* Oct. 26, 1993**

[54] **CASE FOR A MAGNETIC TAPE CASSETTE**

[75] Inventor: **Miya Suwa, Tokyo, Japan**

[73] Assignee: **Sony Corporation, Tokyo, Japan**

[\*\*] Term: **14 Years**

[21] Appl. No.: **721,213**

[22] Filed: **Jun. 25, 1991**

[30] **Foreign Application Priority Data**

Dec. 28, 1990 [JP] Japan ..... 2-43959

[52] U.S. Cl. .... **D3/35; D3/30.1; D3/74; D19/90; D27/157; D27/189**

[58] Field of Search ..... **D3/30.1, 35, 39, 56, D3/60, 71, 74, 79, 100; D19/75, 76, 90, 91; D27/155, 157, 159, 172, 186, 189, 190, 191; 206/387, 444; 360/133; 431/136**

[56] **References Cited**

**U.S. PATENT DOCUMENTS**

D. 151,202 9/1948 Wolanske ..... D27/159  
D. 282,410 2/1986 Ekuan ..... D3/35

D. 287,546 1/1987 Bernstein ..... D19/76  
D. 314,085 1/1991 Uemura ..... D3/35  
2,692,491 10/1954 Hepburn ..... 431/136

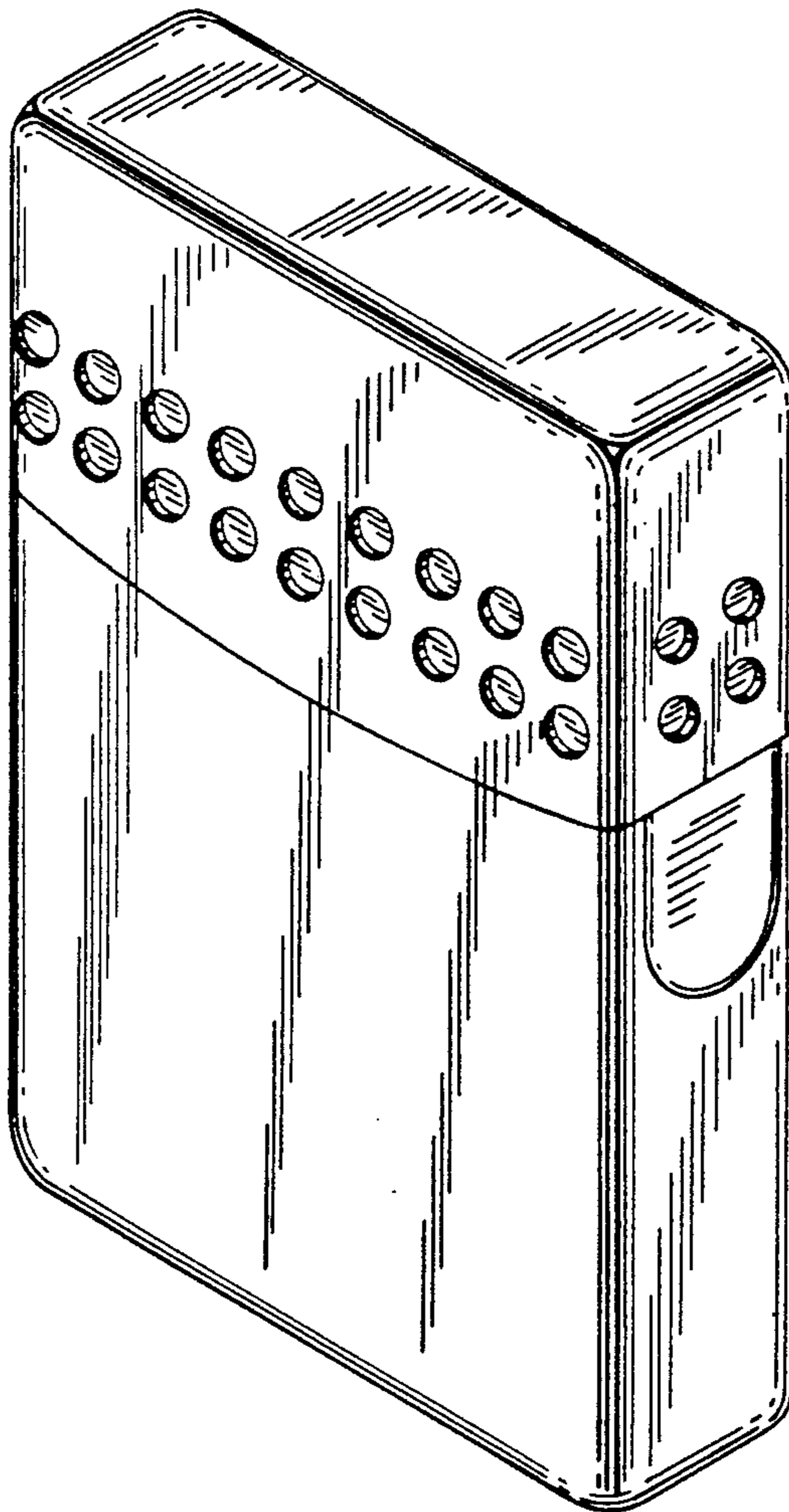
*Primary Examiner*—A. Hugo Word  
*Assistant Examiner*—Celia A. Murphy  
*Attorney, Agent, or Firm*—Lewis H. Eslinger; Jay H. Maioli

[57] **CLAIM**

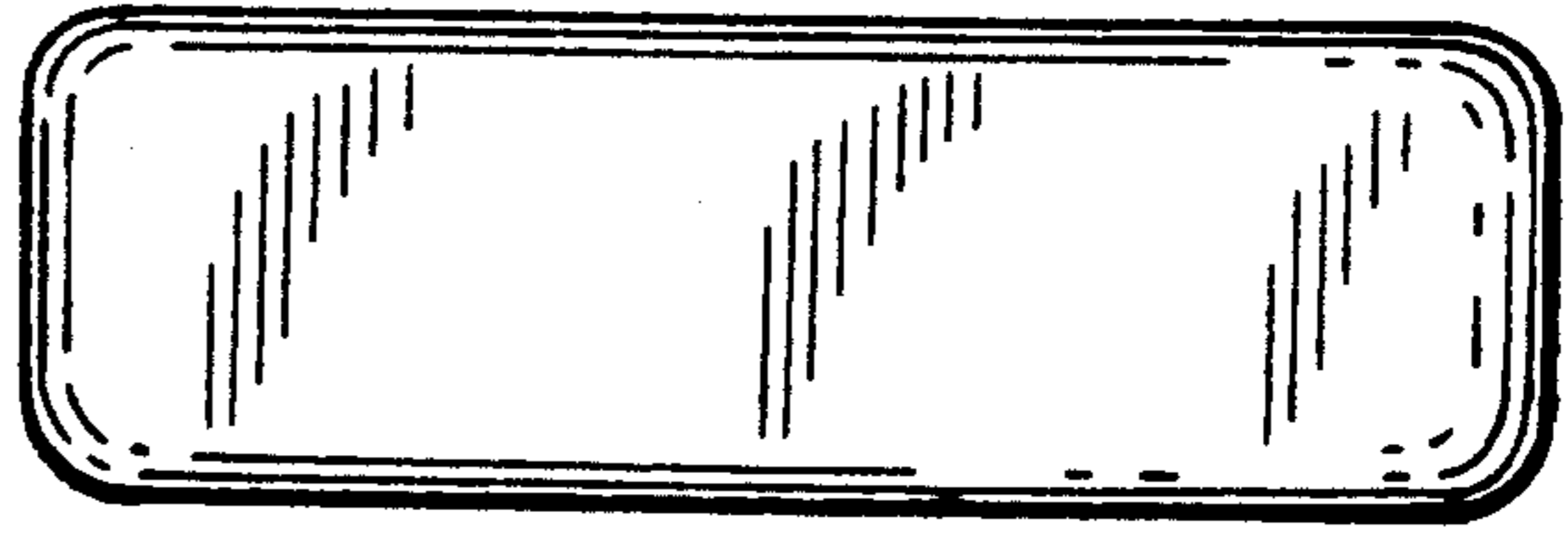
The ornamental design for a case for a magnetic tape cassette, as shown and described.

**DESCRIPTION**

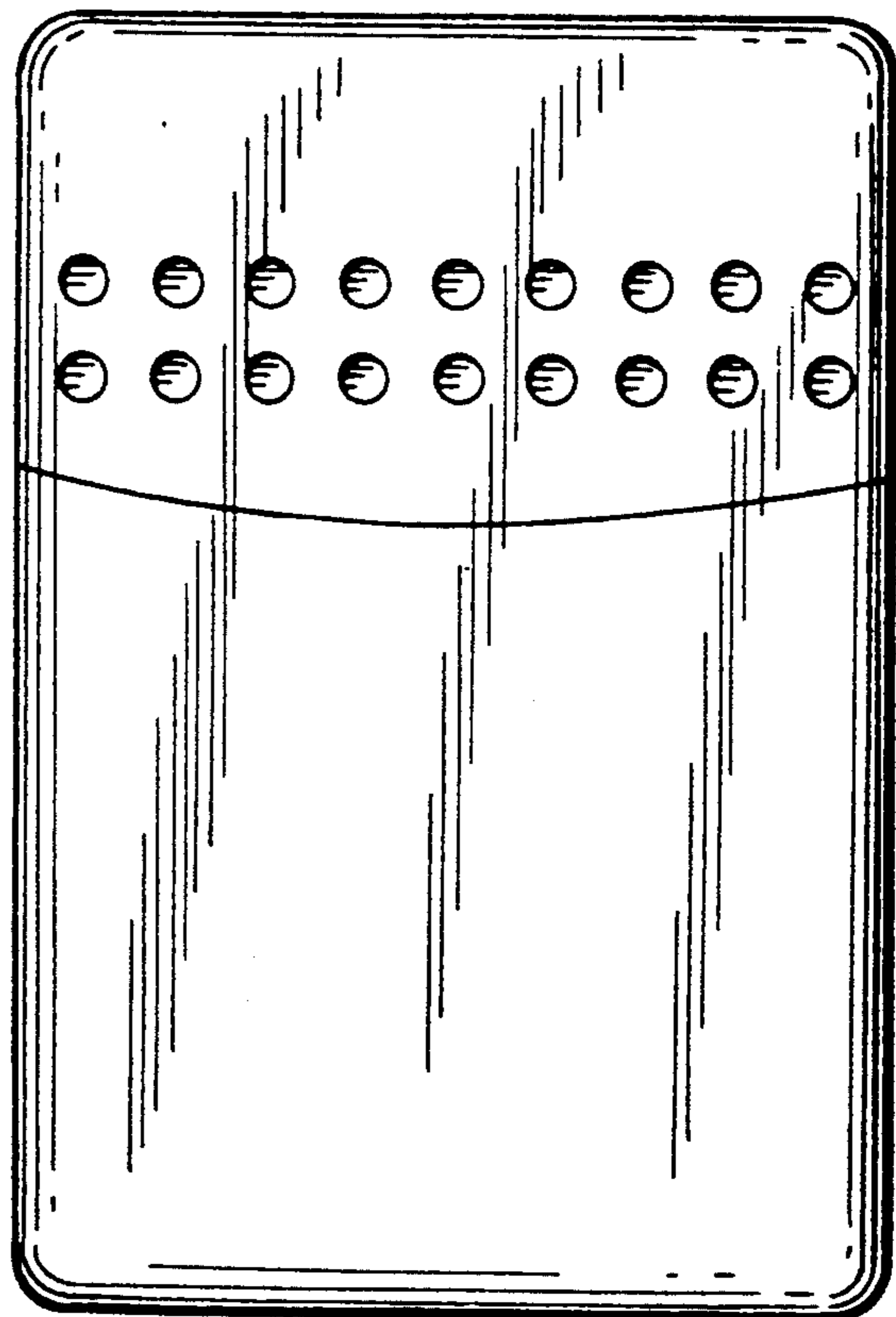
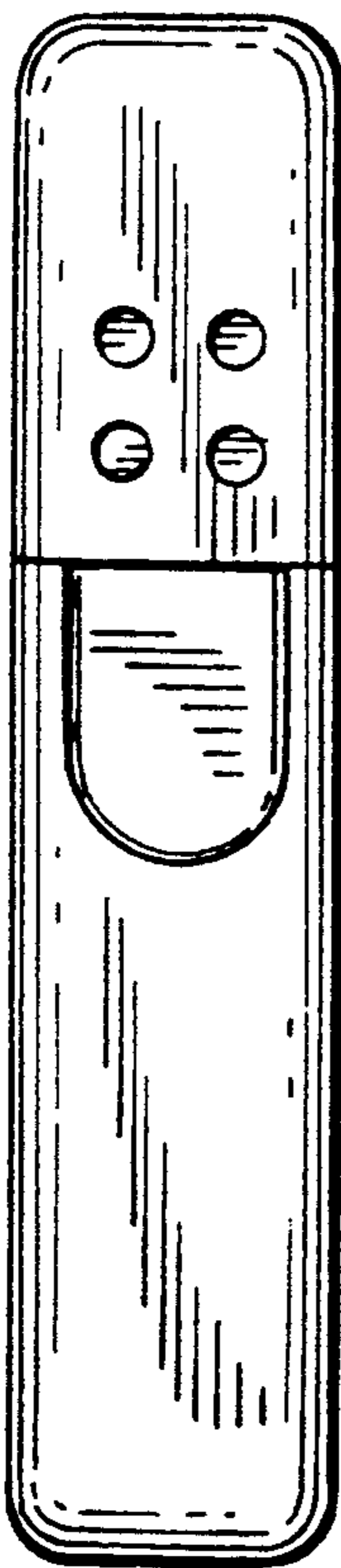
FIG. 1 is a top plan view of a case for a magnetic tape cassette showing my new design;  
FIG. 2 is a left side elevational view thereof;  
FIG. 3 is a front elevational view thereof;  
FIG. 4 is a right side elevational view thereof;  
FIG. 5 is a rear elevational view thereof;  
FIG. 6 is a bottom plan view thereof;  
FIG. 7 is a perspective view thereof; and,  
FIG. 8 is a perspective view thereof, the lid shown removed.



*FIG. 1*

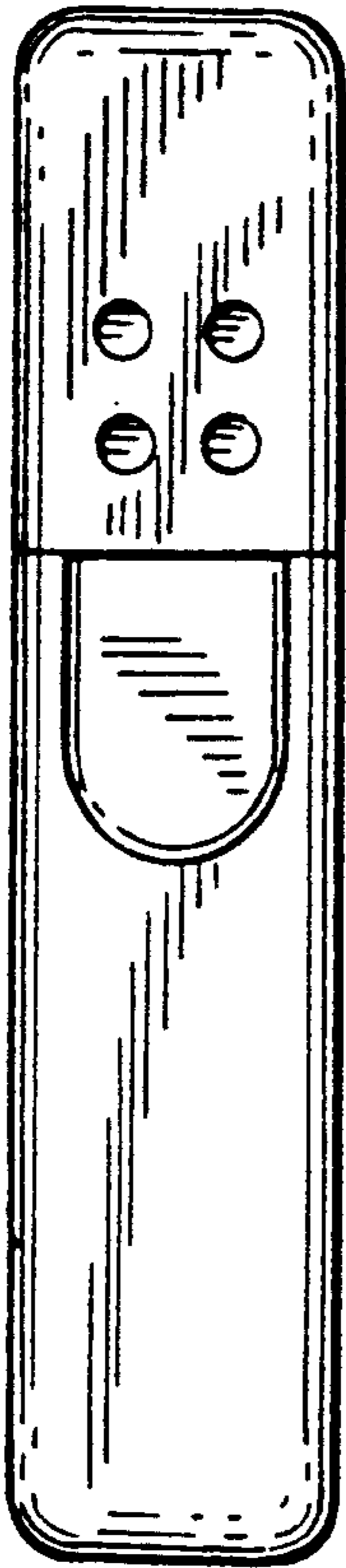


*FIG. 2*

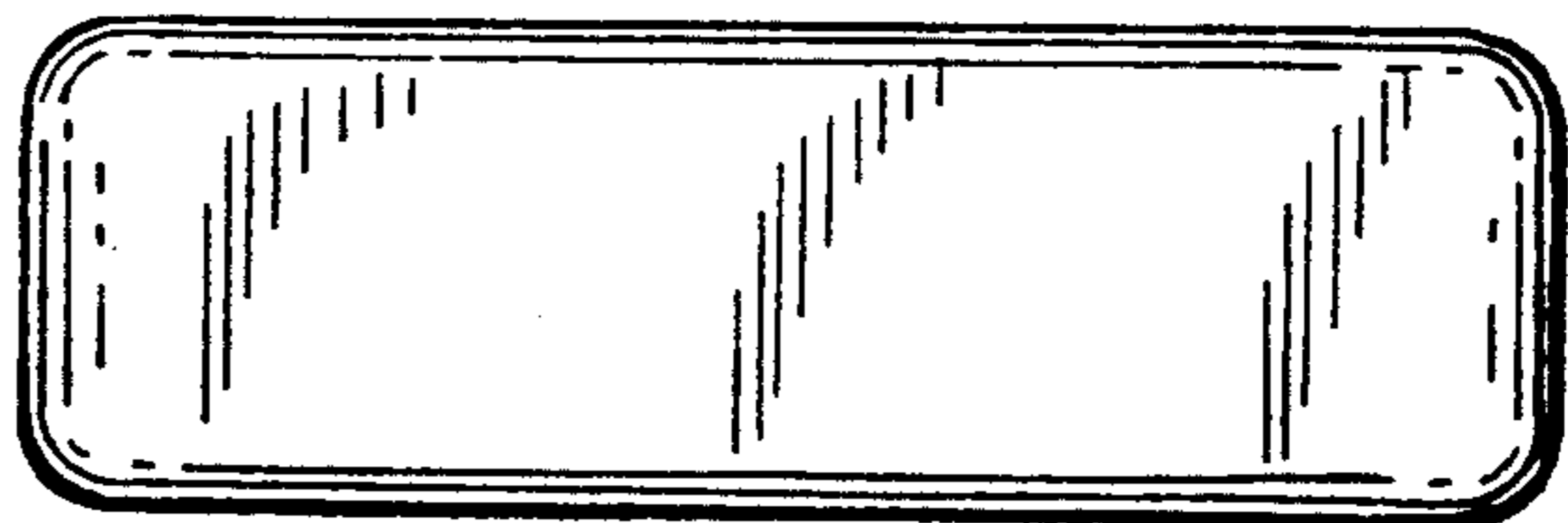
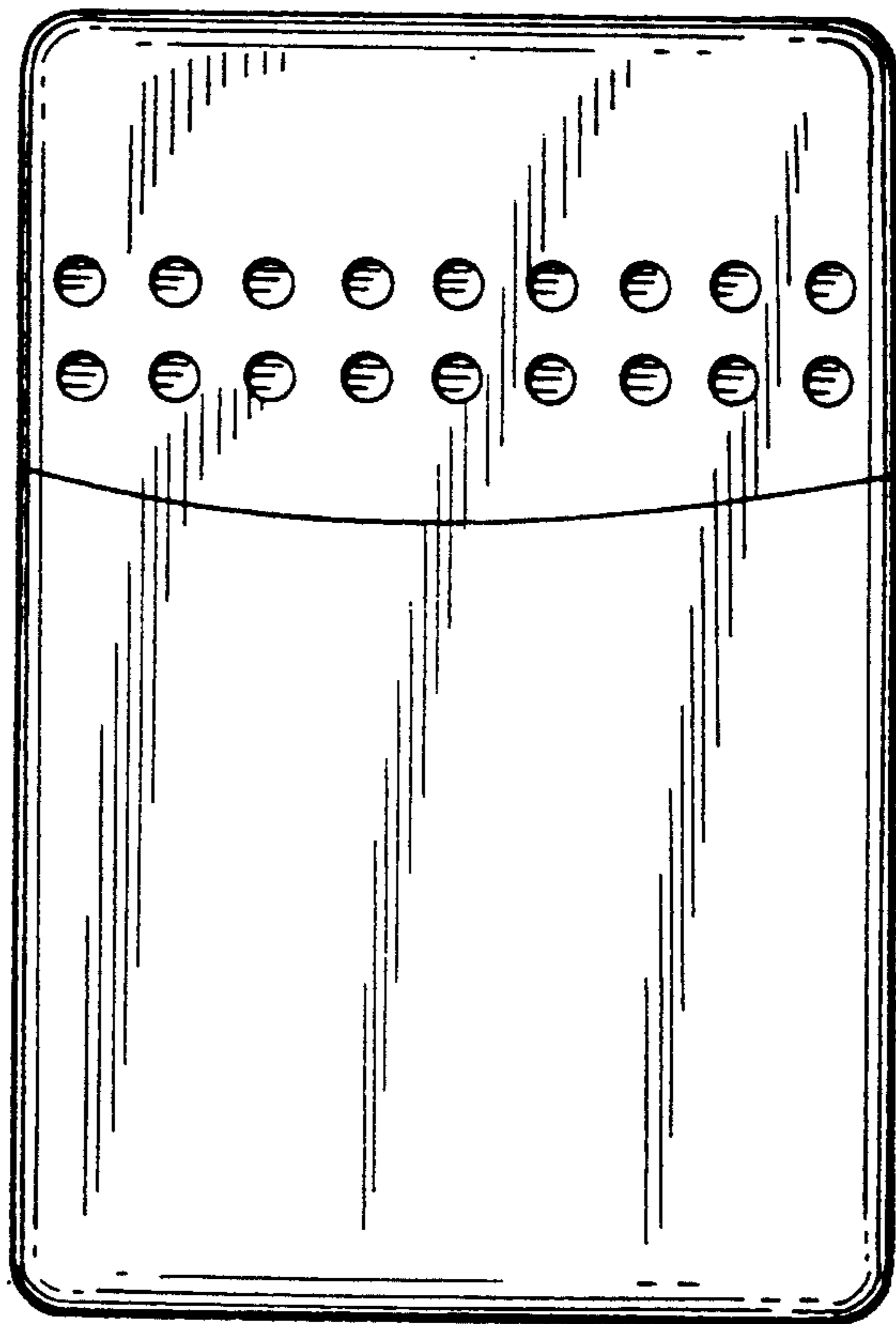


*FIG. 3*

*FIG. 4*



*FIG. 5*



*FIG. 6*

*FIG. 7*

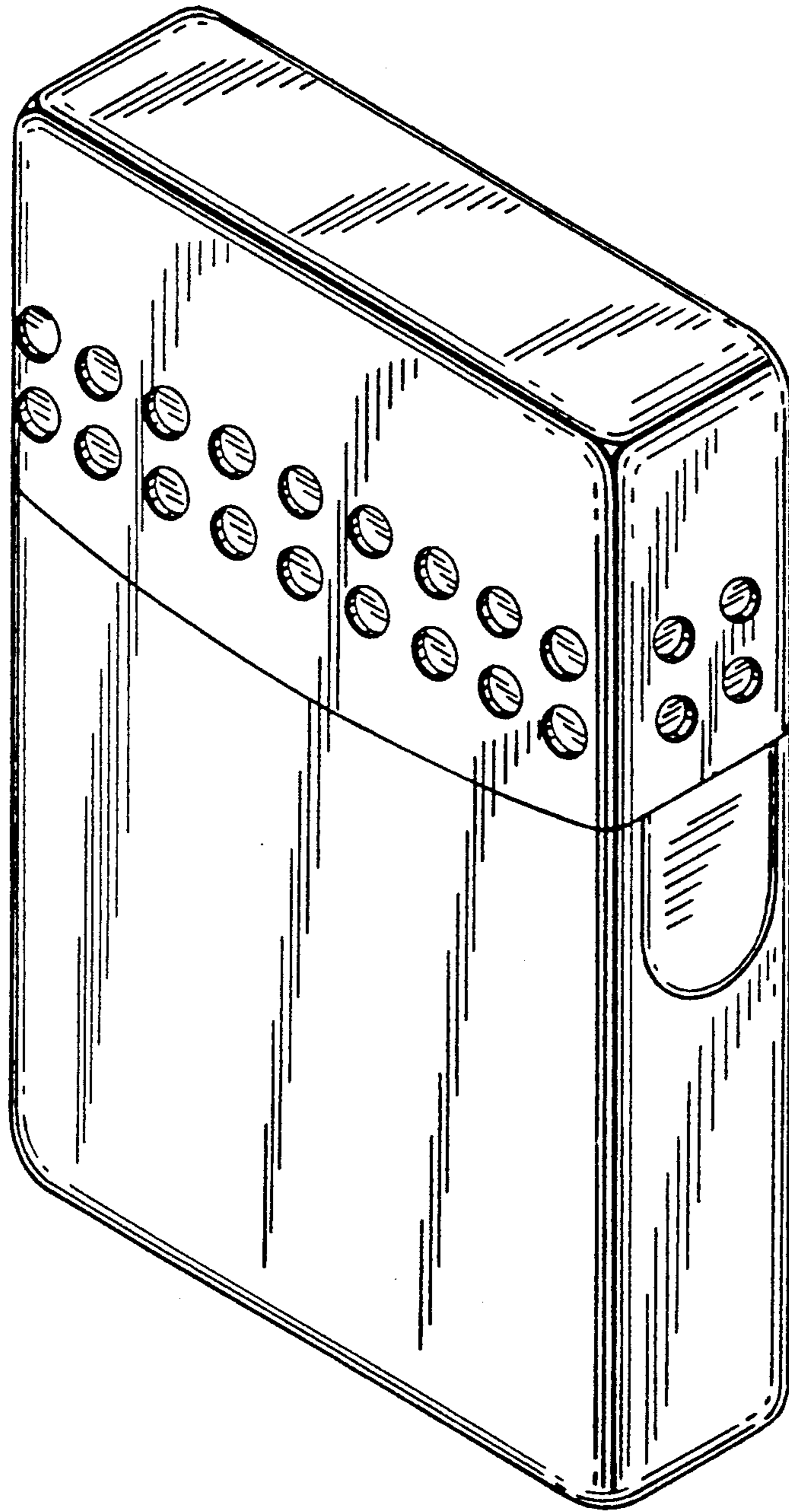


FIG. 8

