



US00D340558S

United States Patent [19]

Winters

[11] Patent Number: **Des. 340,558**

[45] Date of Patent: **** Oct. 19, 1993**

[54] DIPSTICK CLEANER

[76] Inventor: **Ronald Winters**, #17-5931 Island Hwy. N., Nanaimo, BC, Canada, V9T 1X1

[**] Term: **14 Years**

[21] Appl. No.: **806,439**

[22] Filed: **Dec. 13, 1991**

[52] U.S. Cl. **D32/40; D4/137**

[58] Field of Search **D4/137, 199; D32/35, D32/40, 52; 15/210.1, 218.1, 220.4, 244.1**

[56] References Cited

U.S. PATENT DOCUMENTS

| | | | |
|-----------|--------|---------------|------------|
| 1,951,079 | 3/1934 | Zihlman | 15/220.4 |
| 2,113,235 | 4/1938 | Likens | 15/220.4 |
| 4,374,445 | 2/1983 | Wilson | 15/218.1 X |
| 4,380,841 | 4/1983 | Thomas | 15/220.4 |

FOREIGN PATENT DOCUMENTS

2577409 8/1986 France 15/218.1

Primary Examiner—Wallace R. Burke
Assistant Examiner—Lavone D. Tabor
Attorney, Agent, or Firm—Terry M. Gernstien

[57] CLAIM

The ornamental design for a dipstick cleaner, as shown and described.

DESCRIPTION

FIG. 1 is a perspective view of a dipstick cleaner embodying the design of the present invention; FIG. 2 is a top plan view thereof; FIG. 3 is a side elevational view thereof, the side opposite being a mirror image of the side shown in FIG. 3; FIG. 4 is a front elevational view thereof; FIG. 5 is a rear elevational view thereof; and, FIG. 6 is a bottom plan view thereof.

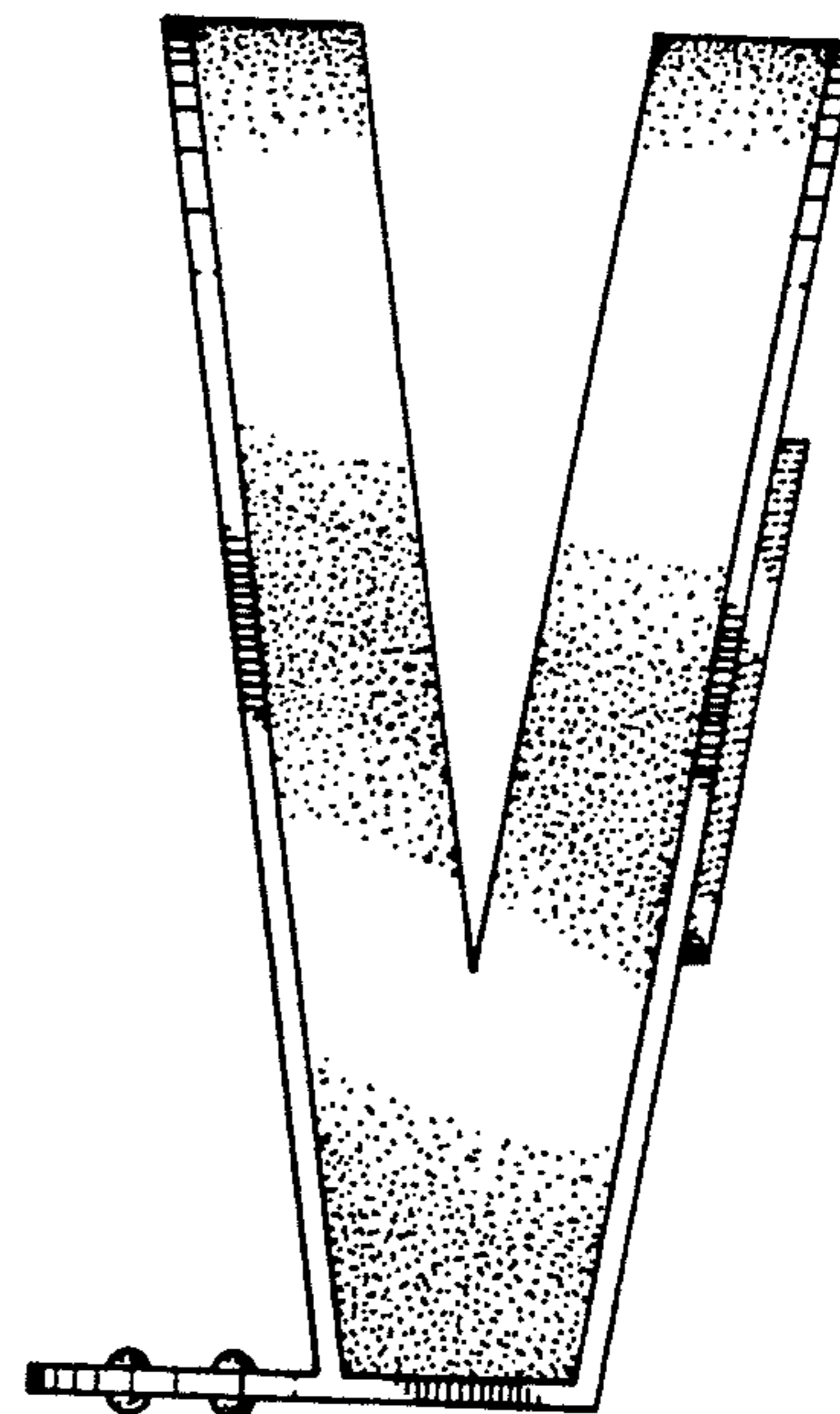
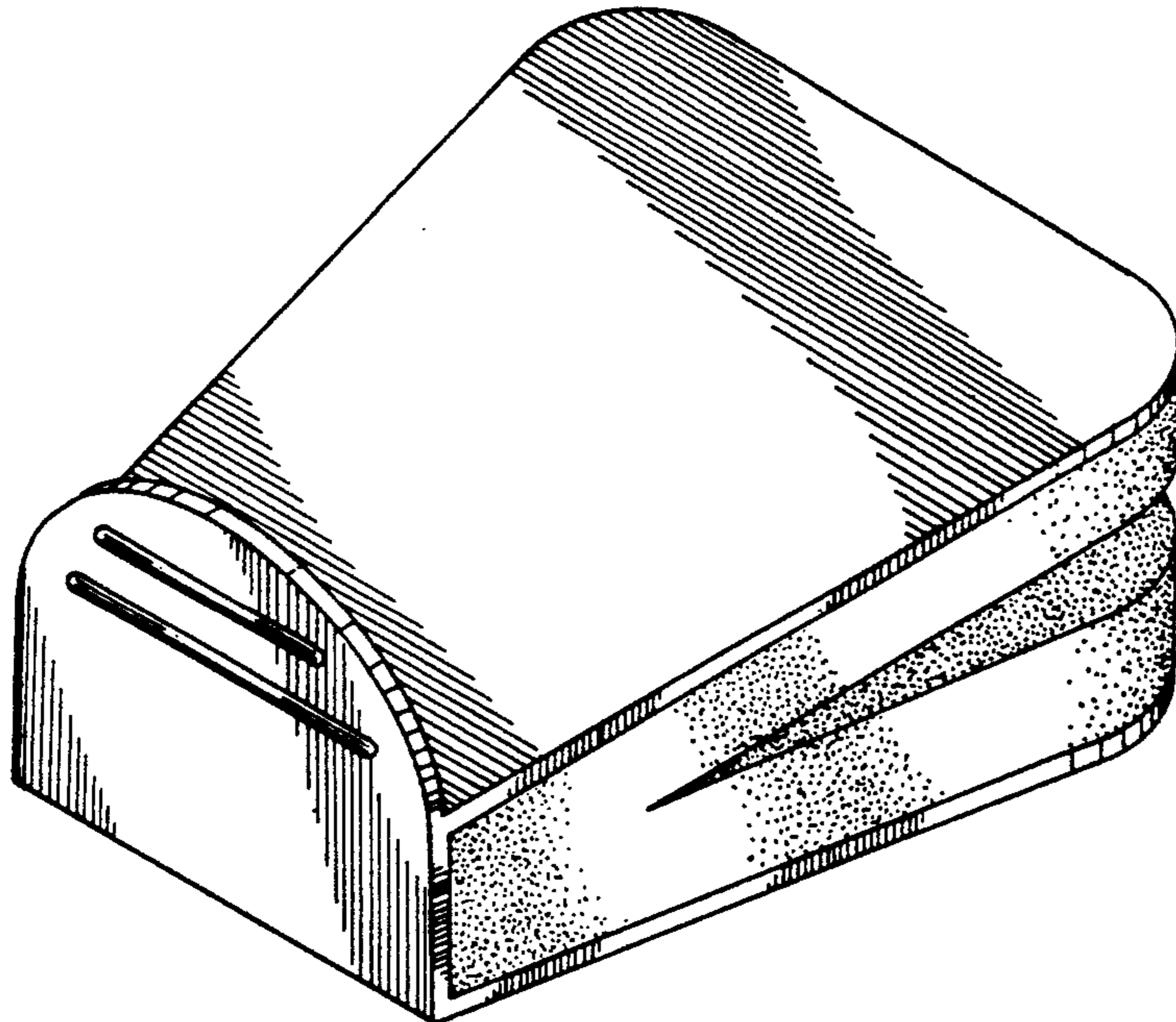

FIG. 1.

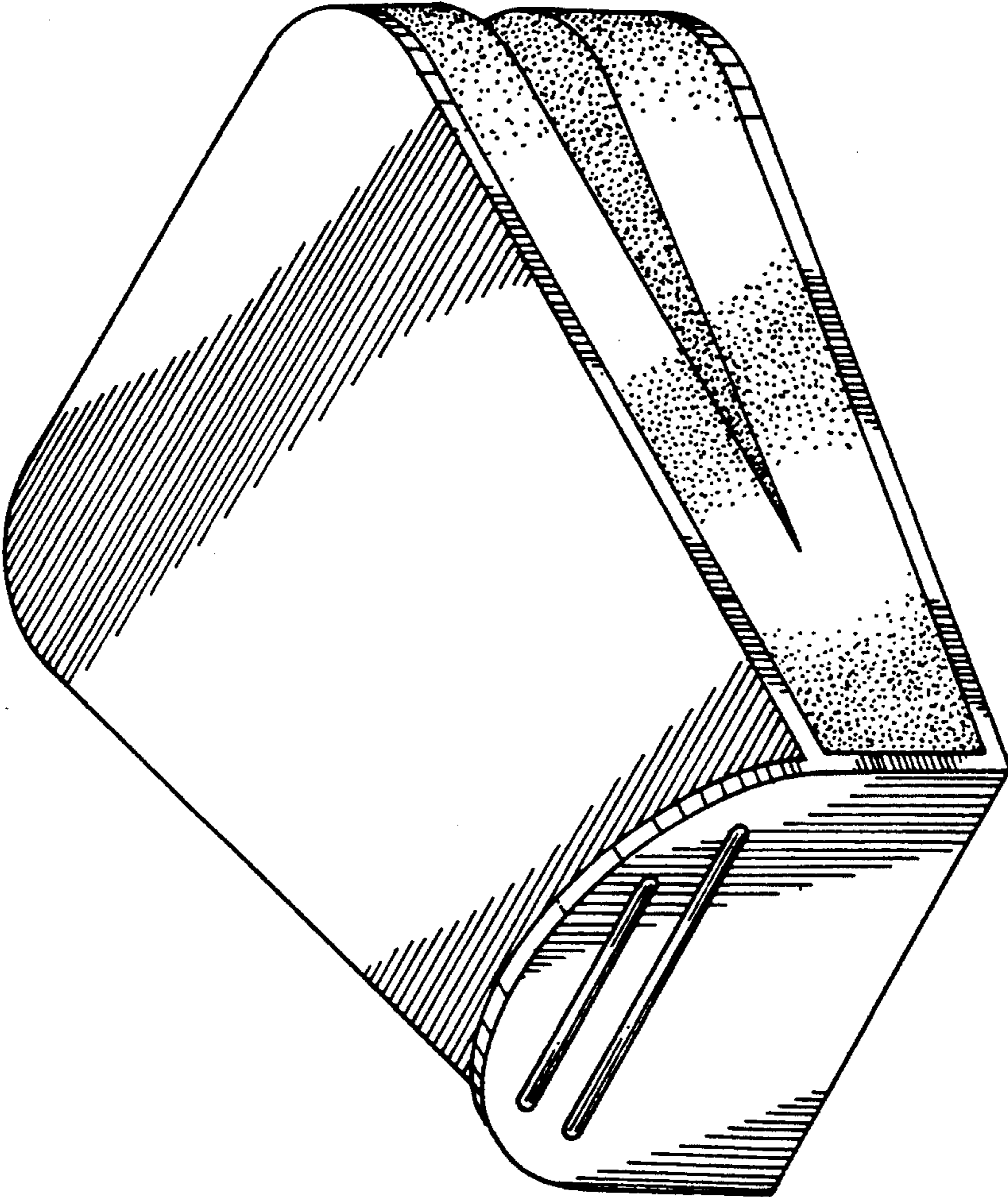

FIG. 2.

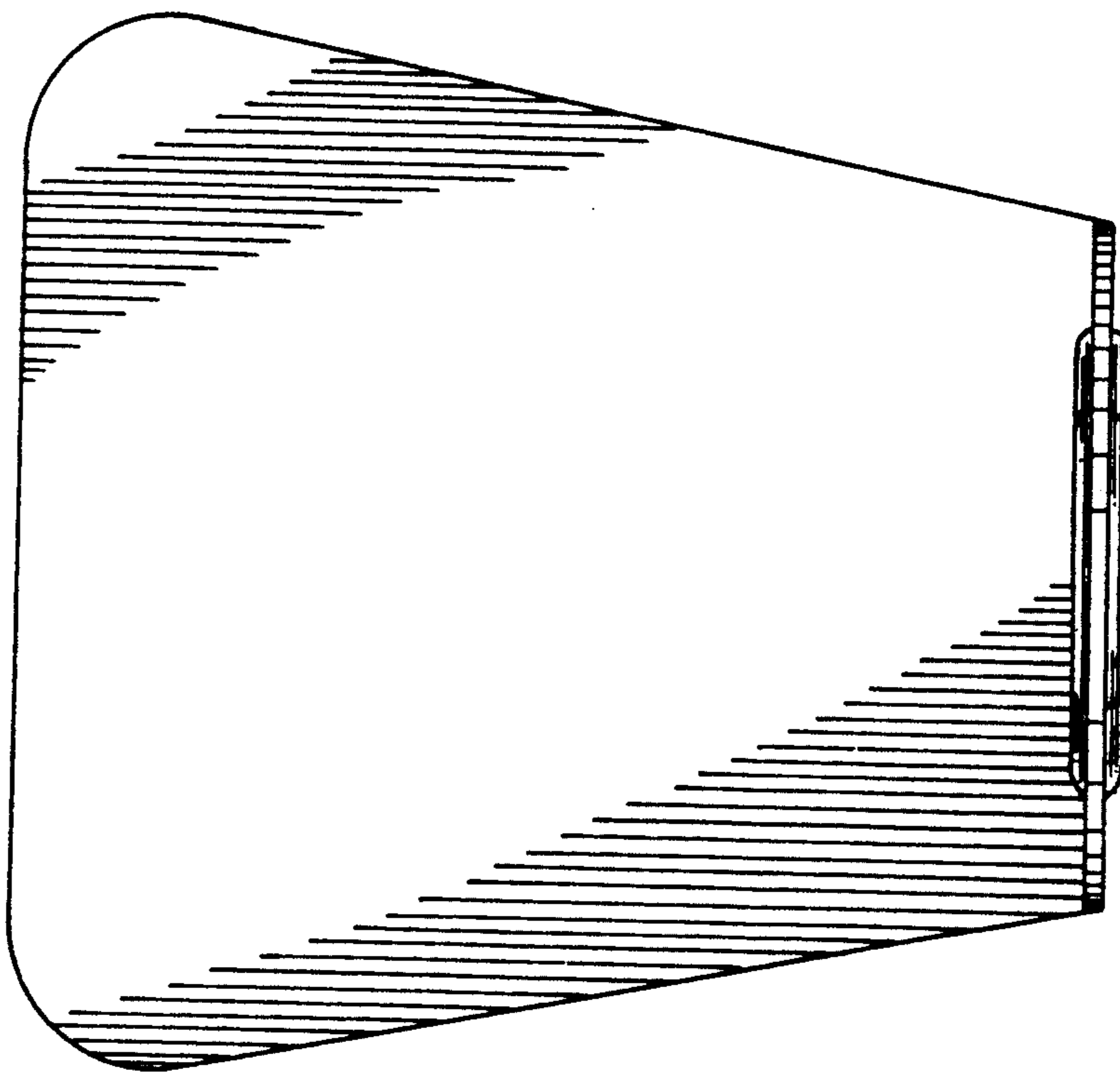
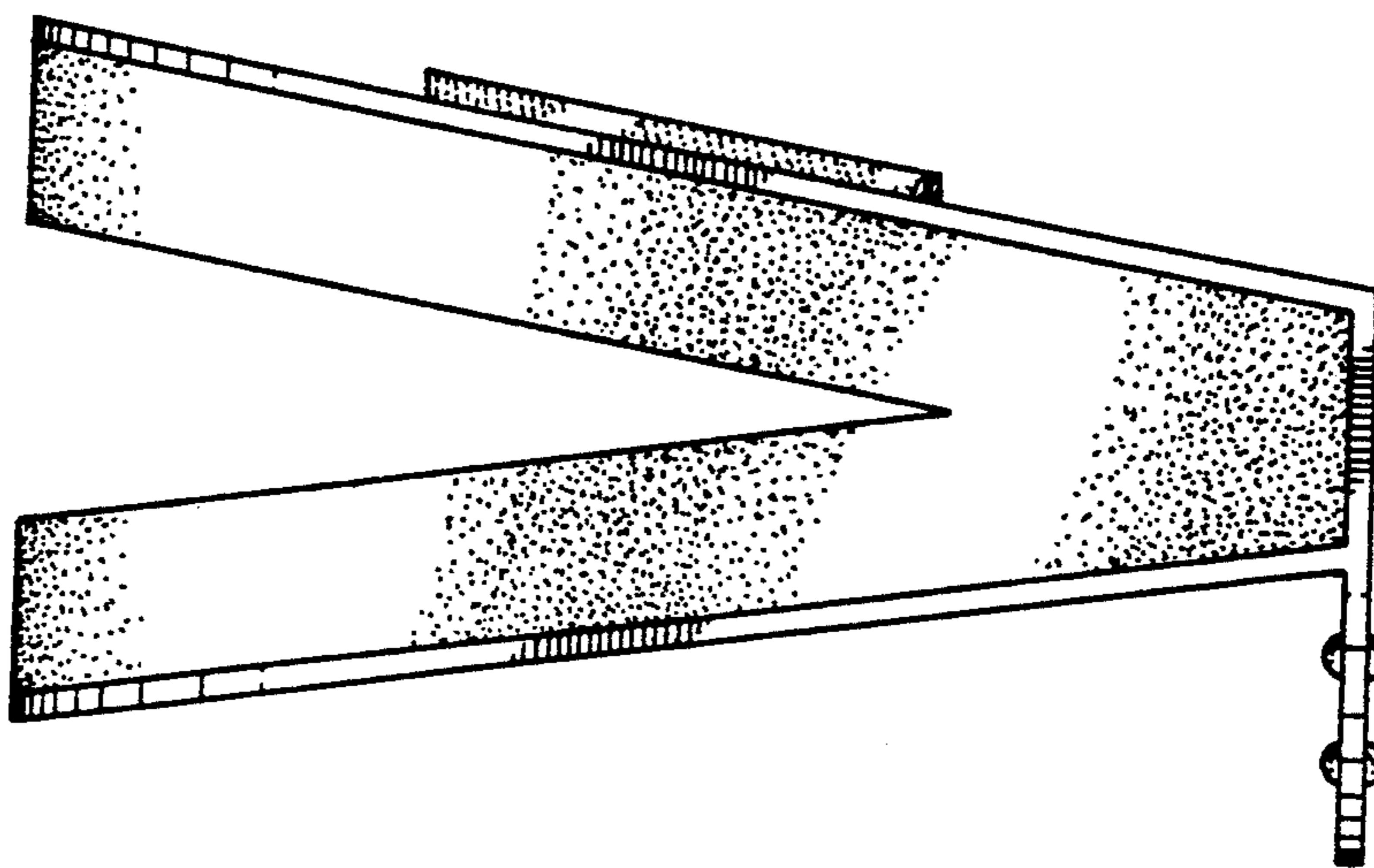

FIG. 3.



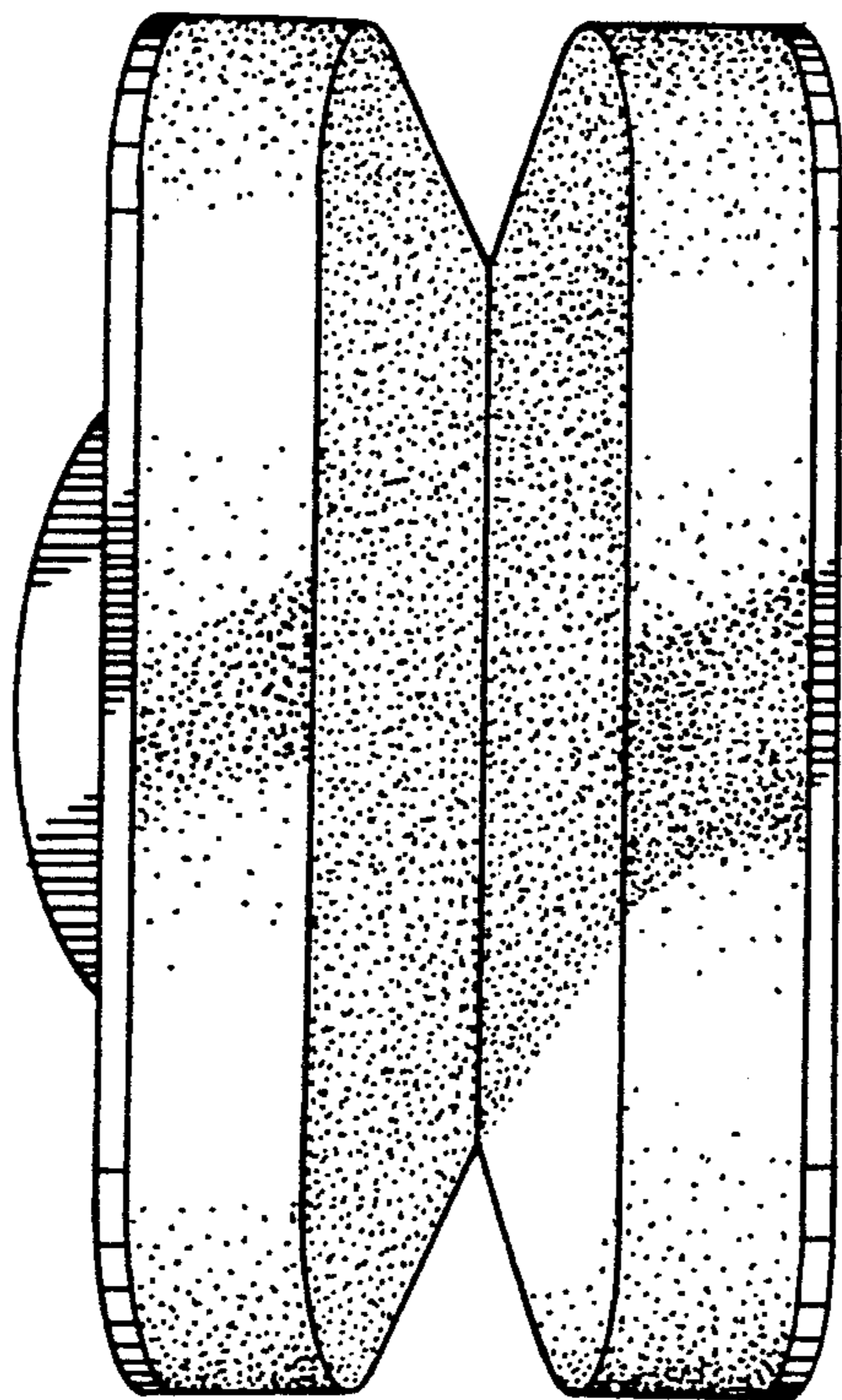

FIG. 4.

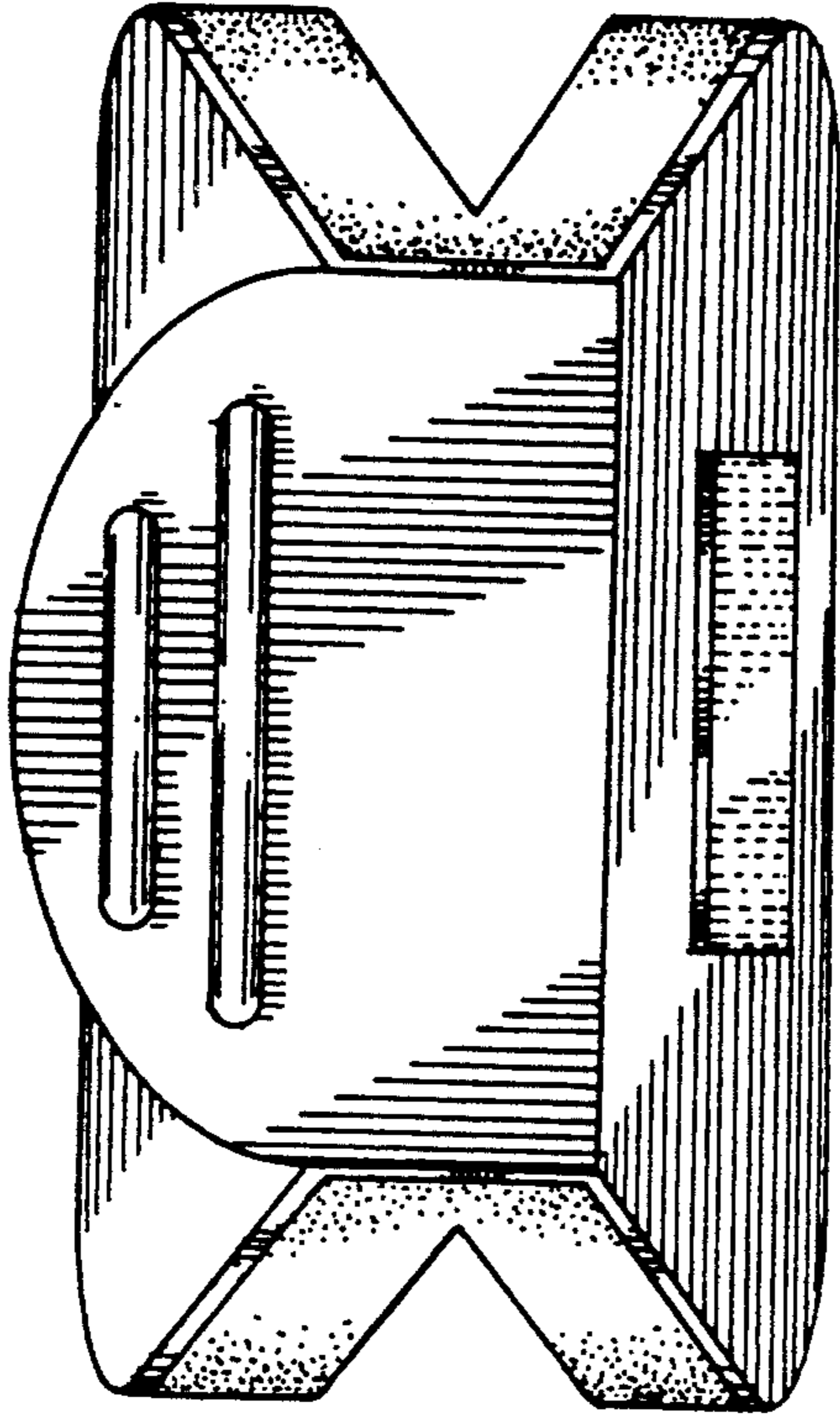

FIG. 5

FIG. 6.

