



US00D340557S

# United States Patent [19]

[11] Patent Number: **Des. 340,557**

**Kardos**

[45] Date of Patent: **\*\* Oct. 19, 1993**

- [54] **SELF-RETRACTING HOSE FOR AN IN-WALL VACUUM SYSTEM**
- [76] Inventor: **Paul M. Kardos**, University of Tampa, Box 1030, Tampa, Fla. 33606
- [\*\*] Term: **14 Years**
- [21] Appl. No.: **772,589**
- [22] Filed: **Oct. 7, 1991**
- [52] U.S. Cl. .... **D32/21**
- [58] Field of Search ..... **D32/1, 14, 21, 31; 15/301, 312.1, 312.2, 313, 314, 315**

*Primary Examiner*—Ruth McInroy  
*Attorney, Agent, or Firm*—Hugh E. Smith

[57] **CLAIM**

The ornamental design for a self-retracting hose for an in-wall vacuum system, as shown and described.

**DESCRIPTION**

FIG. 1 is a front elevational view of a self-retracting hose for an in-wall vacuum system showing my new design;  
 FIG. 2 is a rear elevational view thereof;  
 FIG. 3 is a left side elevational view thereof;  
 FIG. 4 is a right side elevational view thereof;  
 FIG. 5 is a top plan view thereof;  
 FIG. 6 is a bottom plan view thereof; and,  
 FIG. 7 is a front elevational view thereof.

- [56] **References Cited**
- U.S. PATENT DOCUMENTS**
- D. 298,071 10/1988 Irwin ..... D32/14
- 3,676,986 7/1972 Reiling ..... 15/327.2

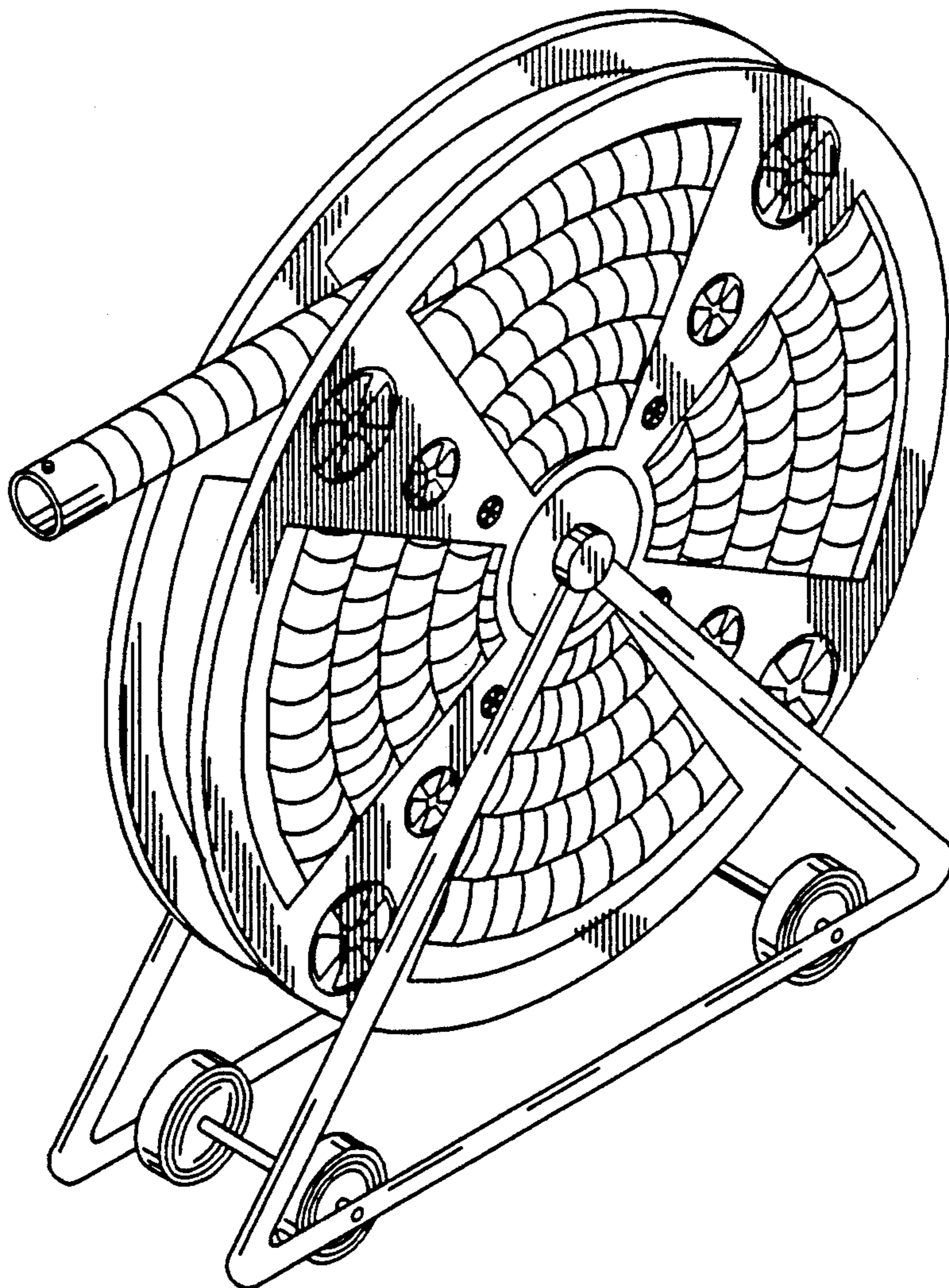

FIG. 1

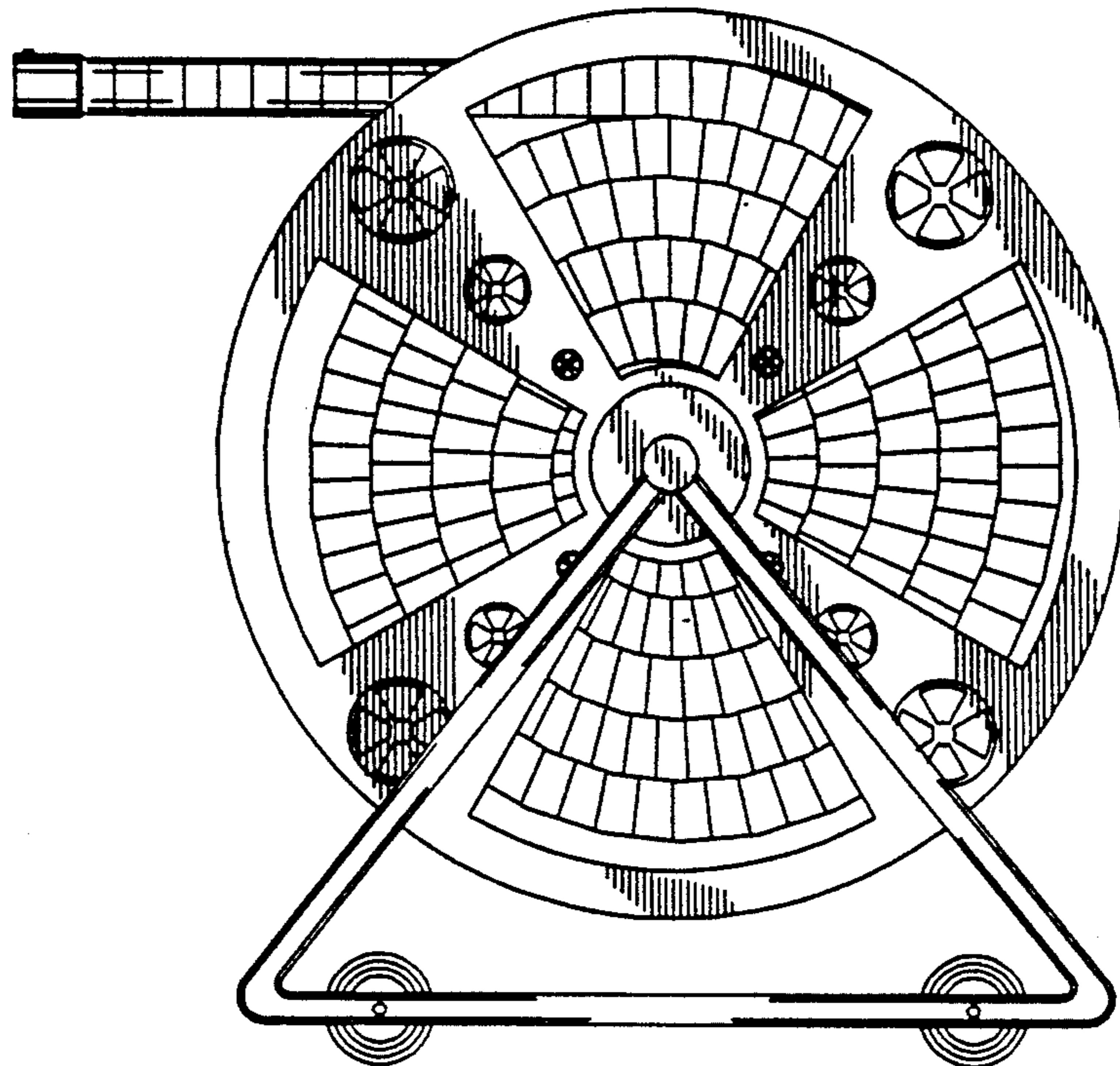

FIG. 2

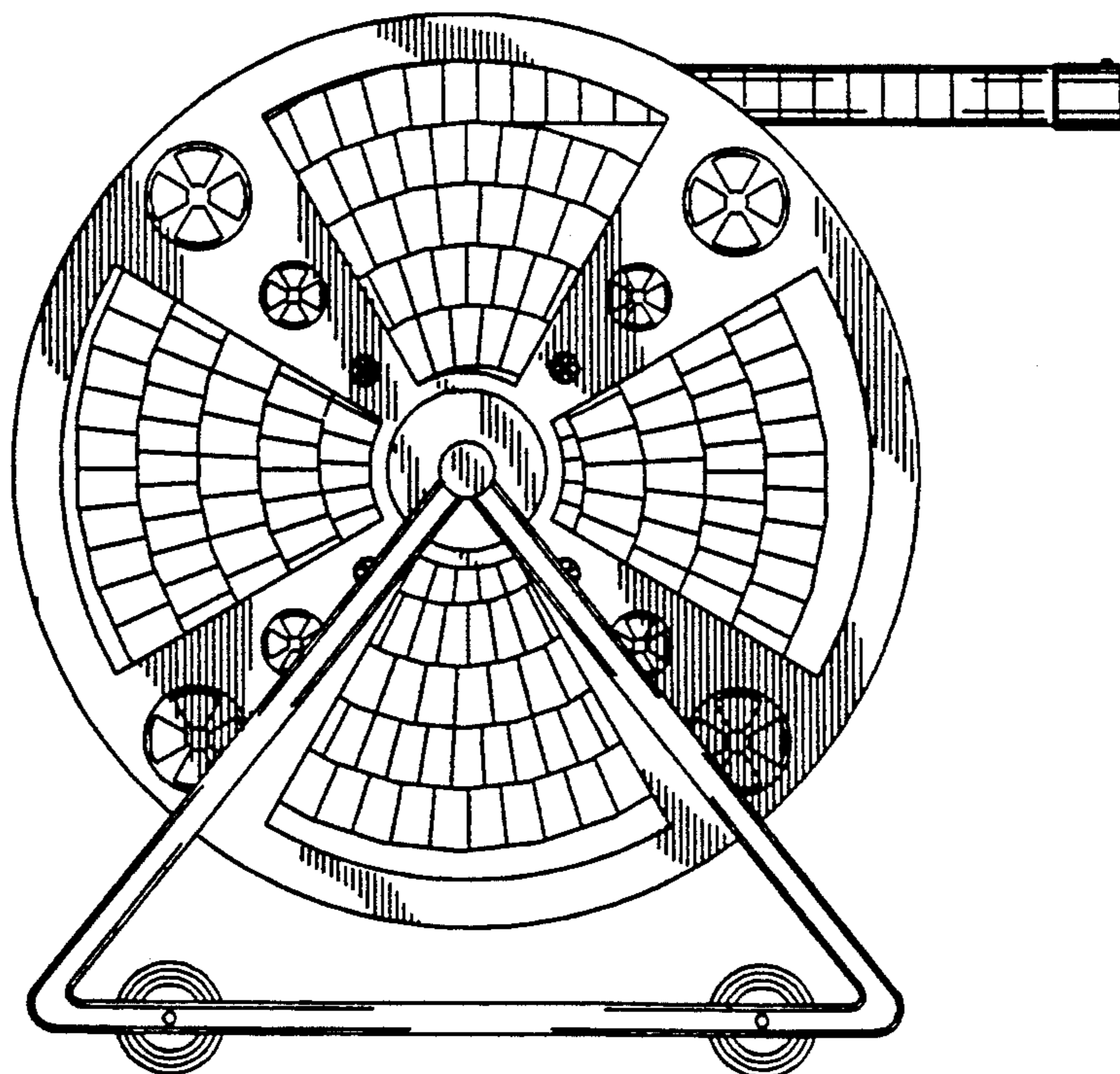

FIG. 3

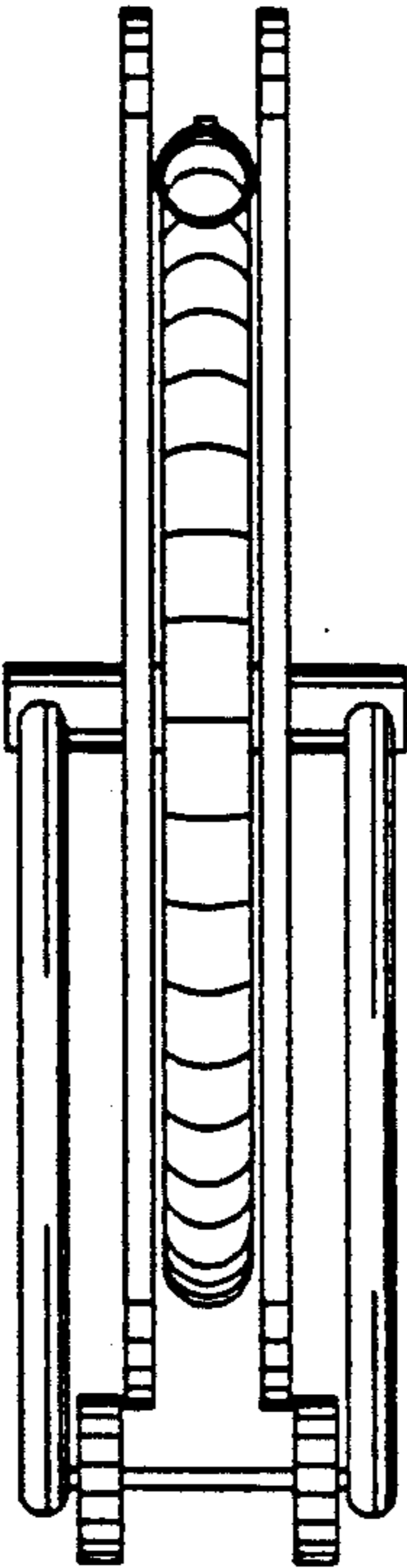

FIG. 4

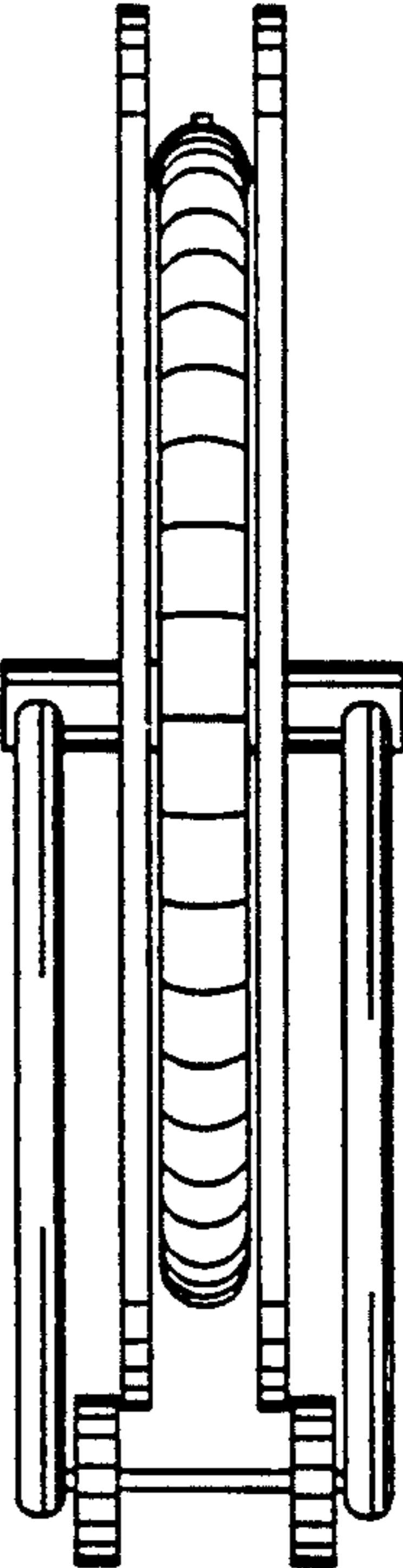

FIG. 5

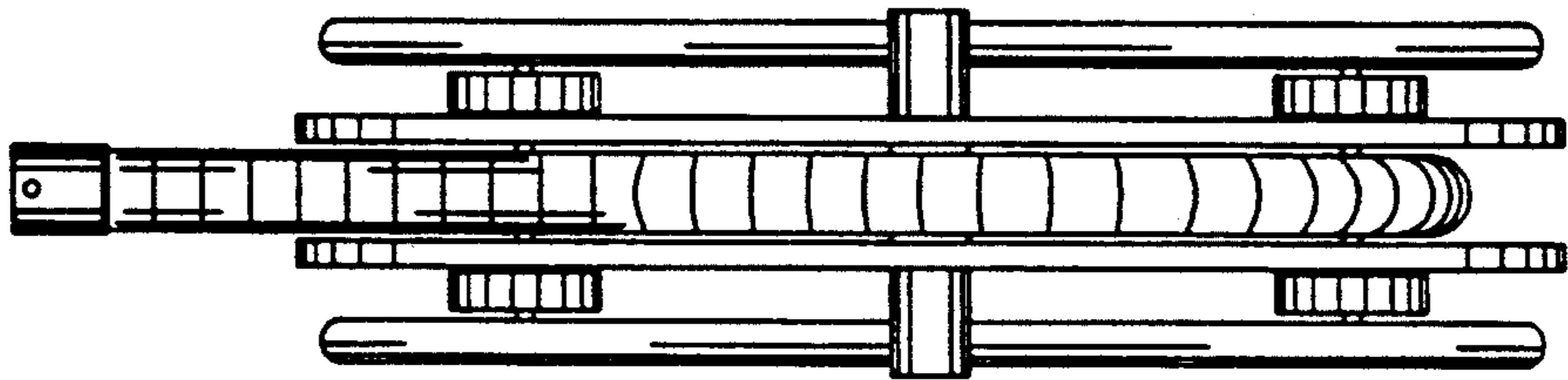

FIG. 6

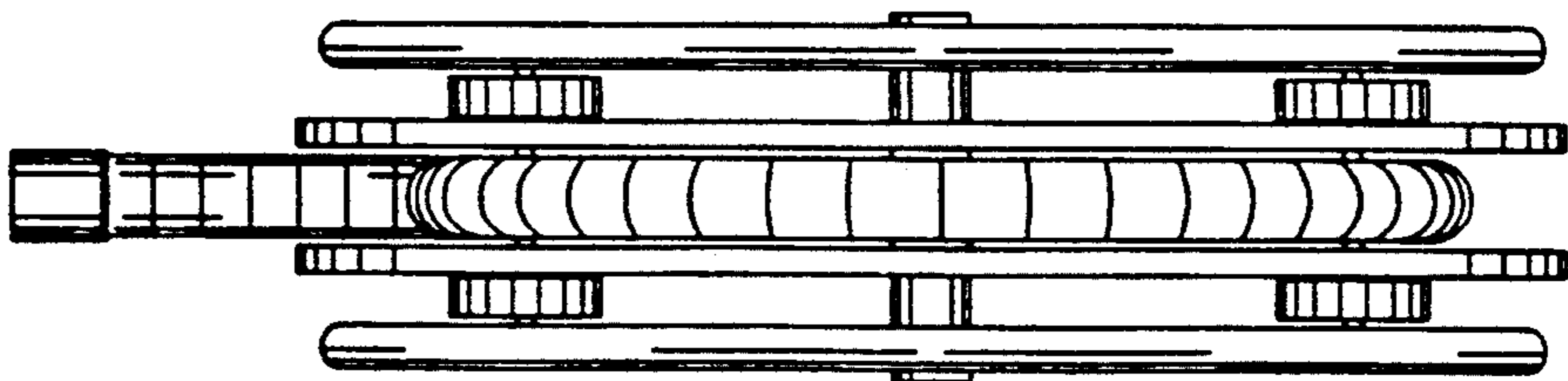



FIG. 7

