



US00D340551S

# United States Patent [19]

Mitchell, Sr.

[11] Patent Number: **Des. 340,551**

[45] Date of Patent: **\*\* Oct. 19, 1993**

## [54] PORTABLE HEATED DOG HOUSE

[76] Inventor: **James Mitchell, Sr.**, 2830 Mountain Ter., Memphis, Tenn. 38127

[\*\*] Term: **14 Years**

[21] Appl. No.: **688,986**

[22] Filed: **Apr. 22, 1991**

[52] U.S. Cl. .... **D30/109**

[58] Field of Search ..... **D30/108-109, D30/110-112, 117-120; 119/15-17, 19; D25/16; D21/114**

### [56] References Cited

#### U.S. PATENT DOCUMENTS

D. 238,883	2/1976	Chailleux et al. ....	D30/108
3,084,667	4/1963	Felhofer et al. ....	D30/109
3,160,139	12/1964	Wales, Jr. ....	119/19
3,866,577	2/1975	Mathis ....	119/19

### FOREIGN PATENT DOCUMENTS

398216	5/1909	France .....	119/19
18077	of 1893	United Kingdom .....	119/19
25212	of 1905	United Kingdom .....	119/19

*Primary Examiner*—A. Hugo Word  
*Assistant Examiner*—Cathy Anne MacCormac  
*Attorney, Agent, or Firm*—Leon Gilden

### [57] CLAIM

The ornamental design for a portable heated dog house, as shown and described.

### DESCRIPTION

FIG. 1 is a front elevational view of the portable heated dog house showing my new design; FIG. 2 is a rear elevational view thereof; FIG. 3 is a left side elevational view thereof; FIG. 4 is a right side elevational view thereof; FIG. 5 is a top plan view thereof; FIG. 6 is a bottom plan view thereof; and, FIG. 7 is a perspective view thereof.

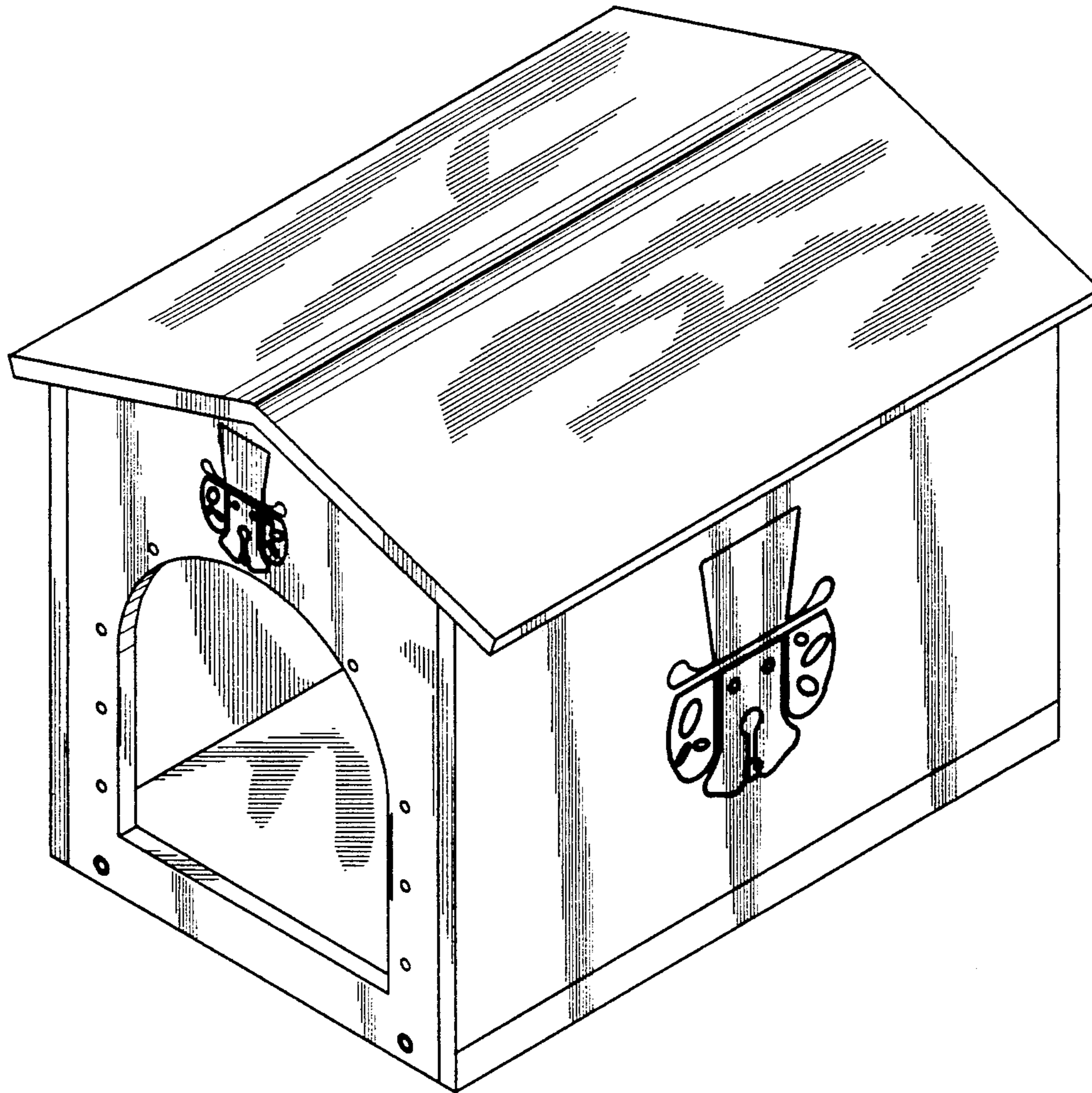

FIG. 1

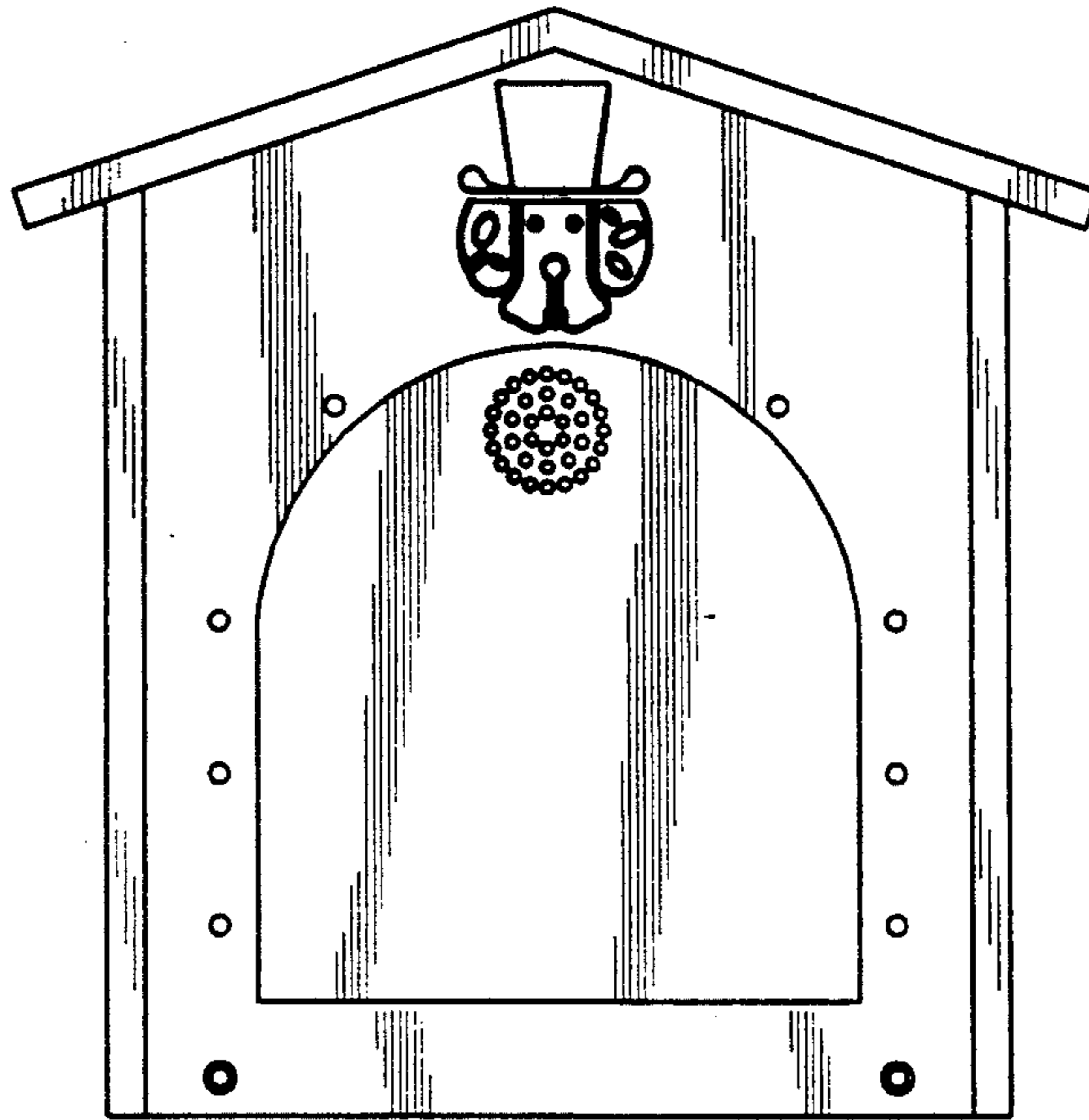

FIG. 2

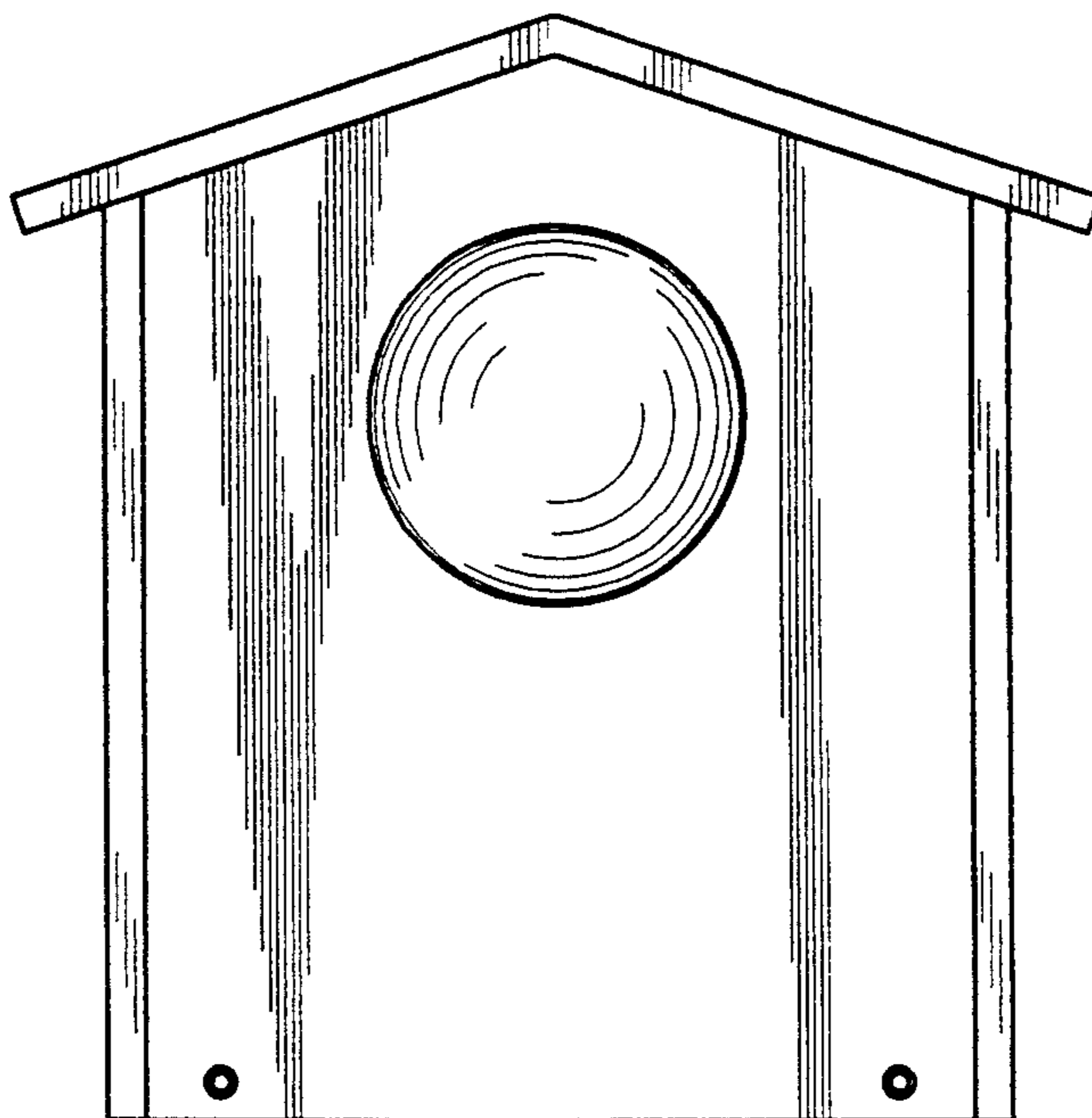

FIG. 3

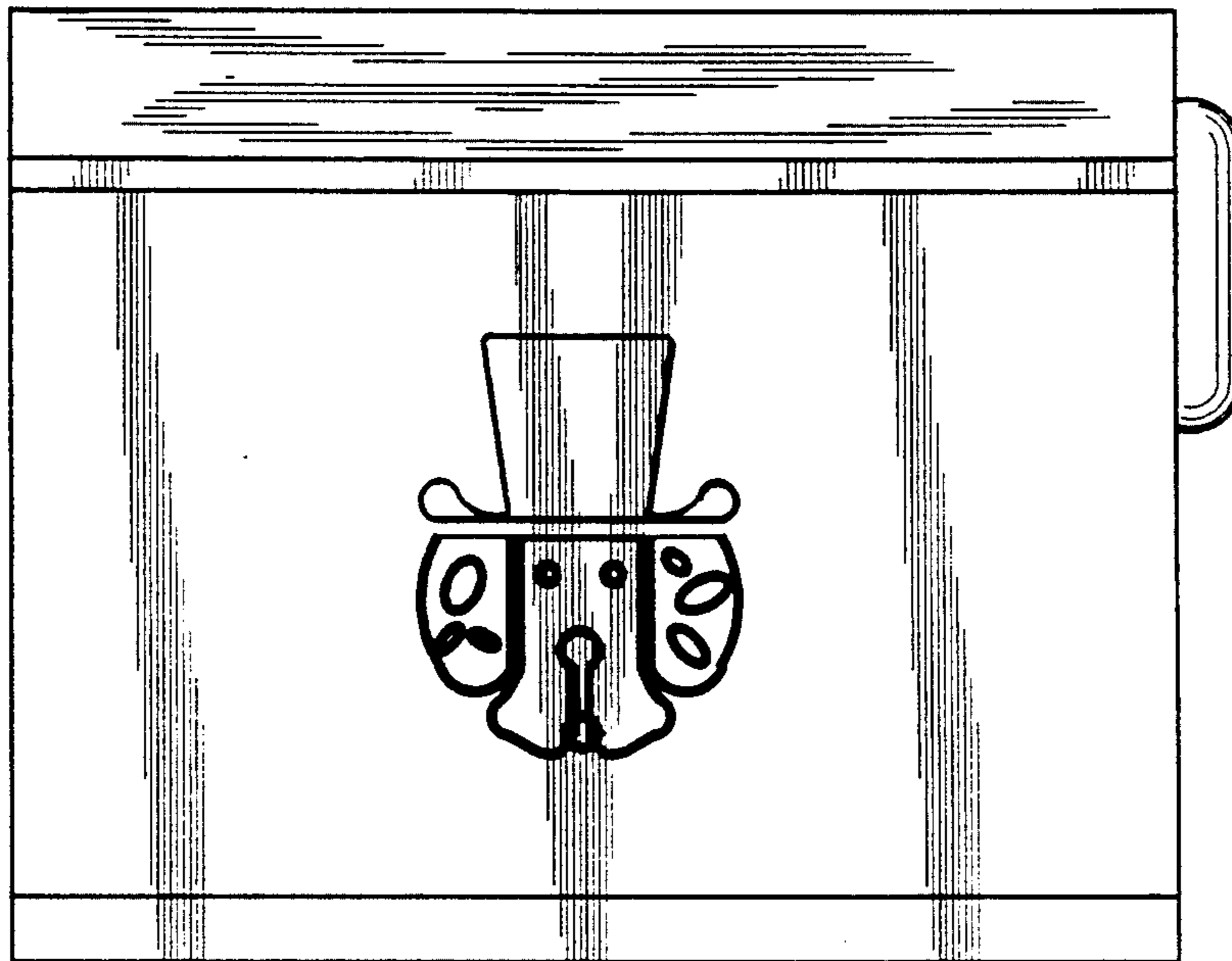

FIG. 4

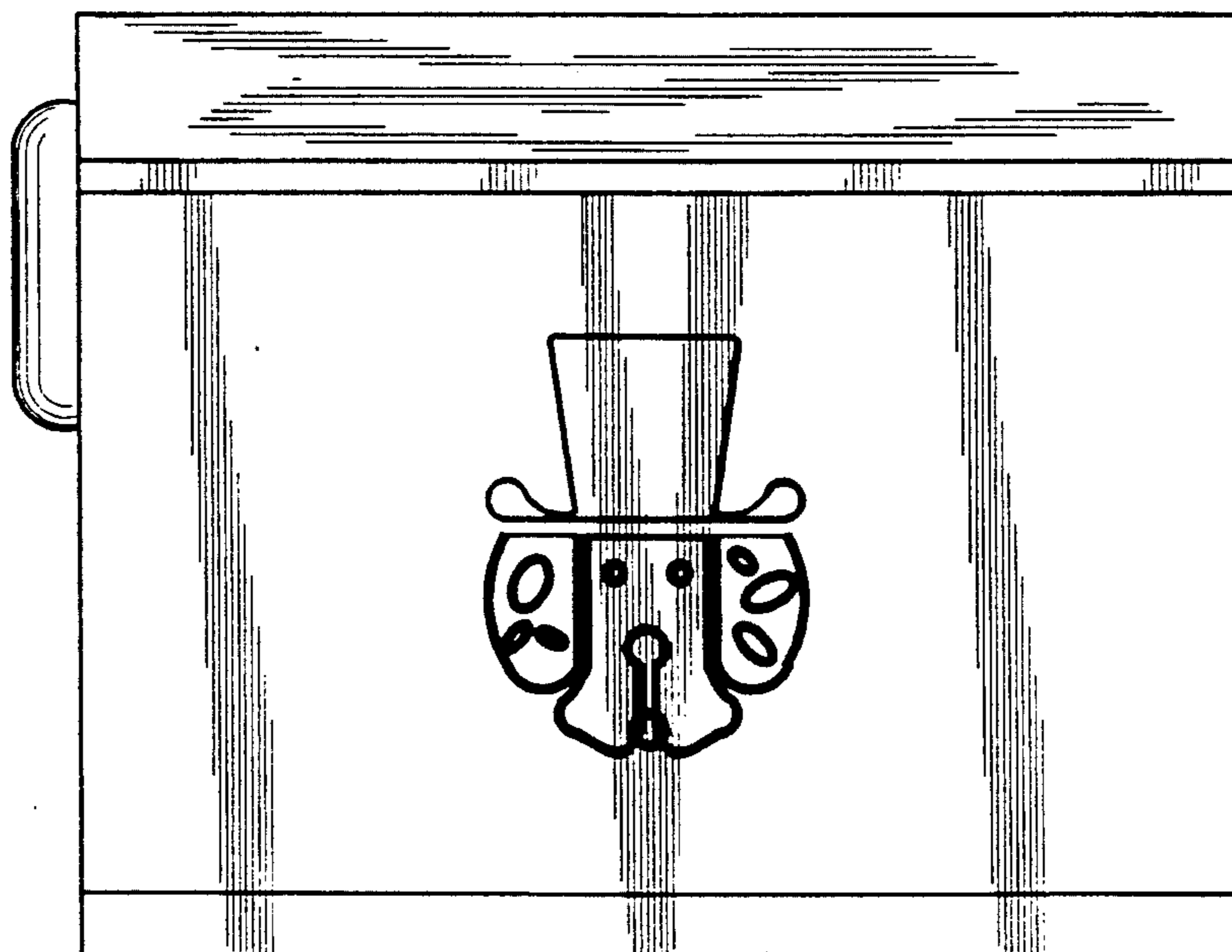

FIG. 5

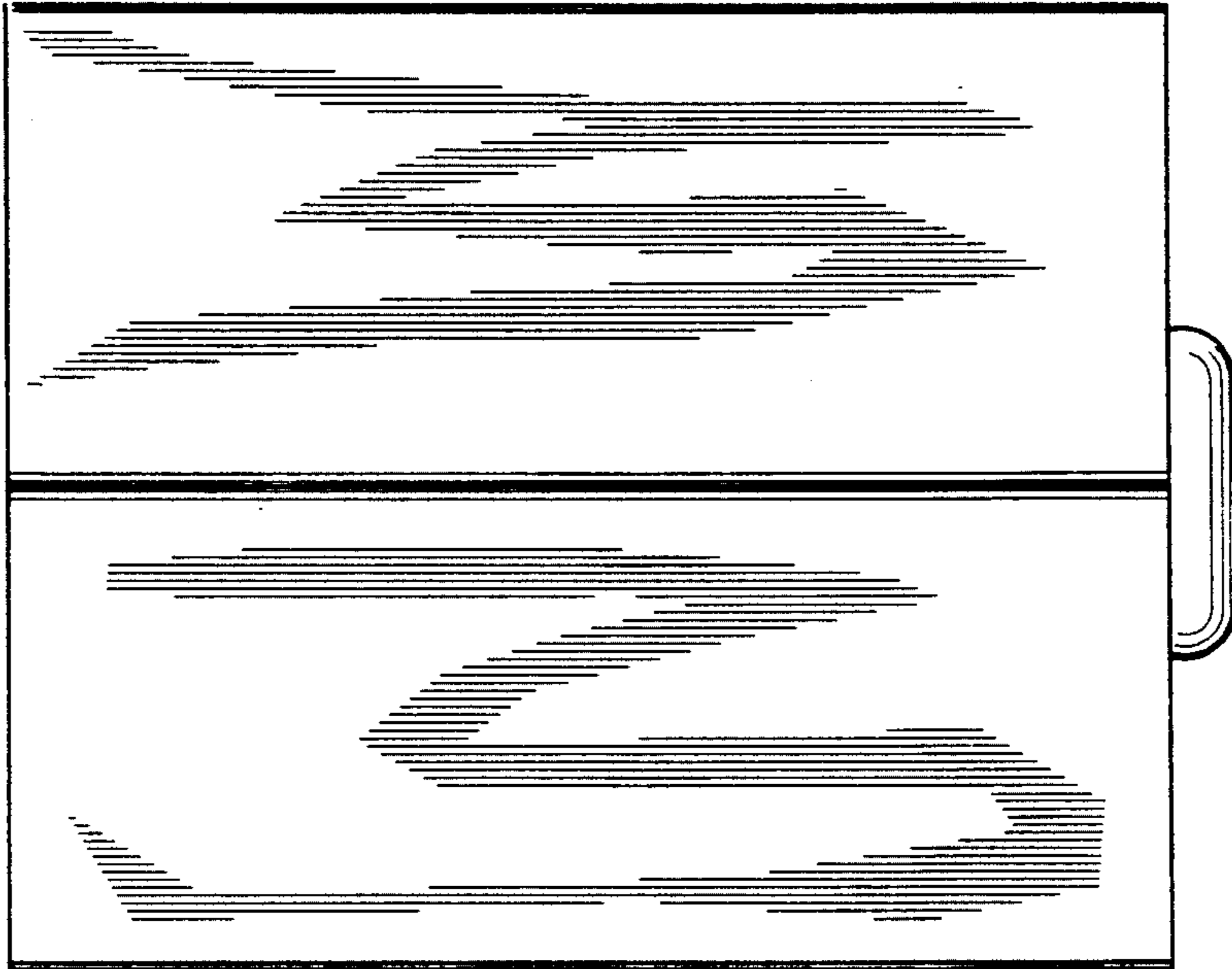

FIG. 6

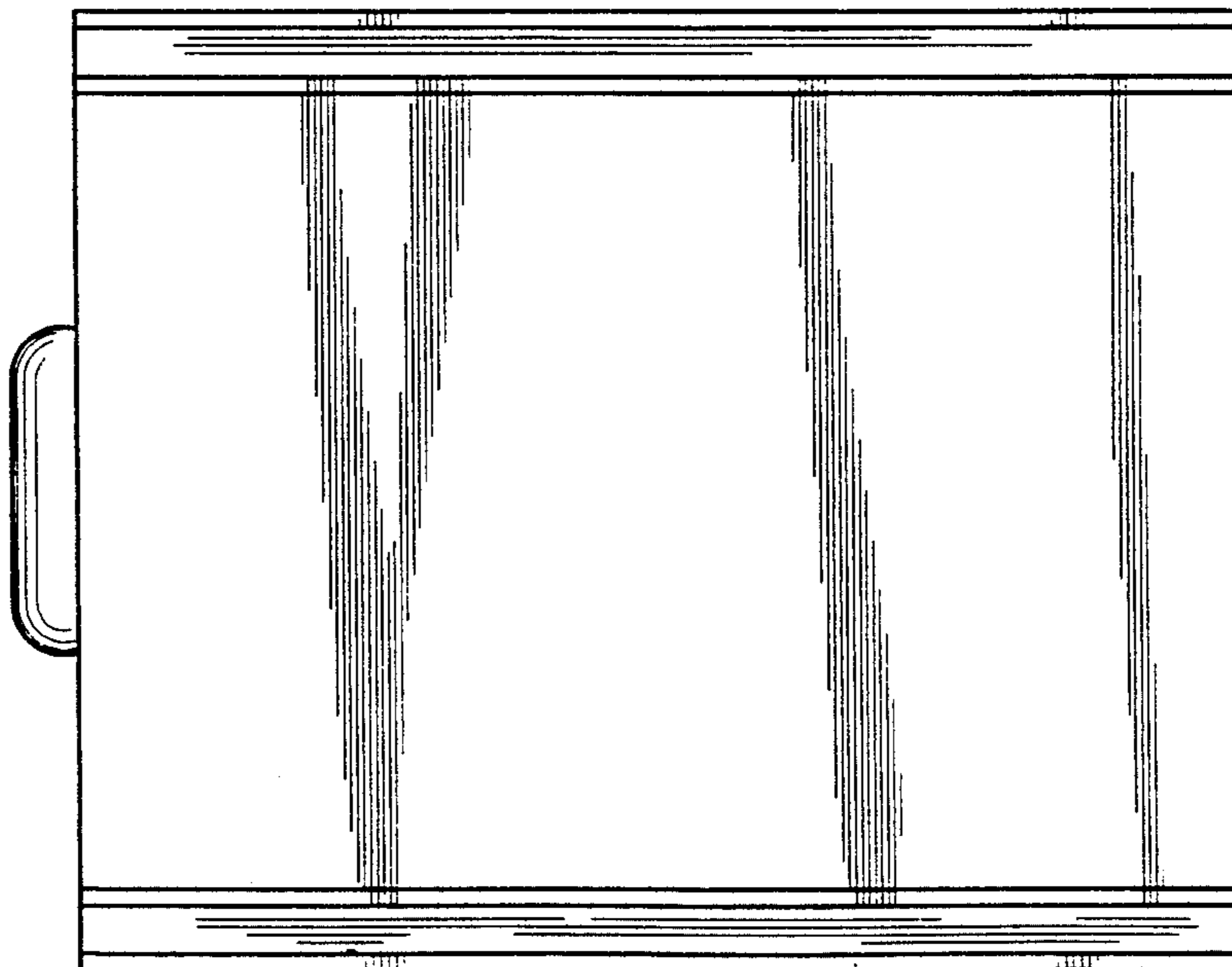

FIG. 7

