



US00D340511S

United States Patent [19]

[11] Patent Number: **Des. 340,511**

Kohler, Jr. et al.

[45] Date of Patent: **** Oct. 19, 1993**

[54] **LAVATORY**

D. 855,616 6/1931 Ebinger .
2,210,933 8/1940 Graf D23/294 X

[75] Inventors: **Herbert V. Kohler, Jr., Kohler, Wis.;
Pierre H. Paulin; Francois Kergoet,
both of Paris, France; Michel
Chalard, Villemomble, France**

[73] Assignee: **Jacob Delafon, Paris, France**

[**] Term: **14 Years**

[21] Appl. No.: **8,042**

[22] Filed: **May 6, 1993**

OTHER PUBLICATIONS

Page 13-9 of an undated Kohler ad showing inter alia its K-3035 Alouette lavatory, admitted prior art.
Undated Ceramica ad for its lavatories, admitted prior art.
Undated Jacob Delafon ad showing inter alia its Cristal lavatory, admitted prior art.
Page 13-5 from an undated Kohler ad showing inter alia its Fleur lavatory, admitted prior art.

Primary Examiner—James R. Largen
Attorney, Agent, or Firm—Quarles & Brady

Related U.S. Application Data

[62] Division of Ser. No. 792,049, Nov. 8, 1991, Pat. No. D. 338,950.

[52] U.S. Cl. **D23/294**

[58] Field of Search **D23/270-275,
D23/284-294; 4/619, 630, 638, 643, 646**

[57] **CLAIM**

The ornamental design for a lavatory, as shown and described.

DESCRIPTION

FIG. 1 is a perspective view taken from the top, front and left side of a lavatory showing our new design; FIG. 2 is a top plan view thereof; FIG. 3 is a front elevational view thereof; FIG. 4 is a left side elevational view thereof, the right side being a mirror image of the left side; FIG. 5 is a cross-sectional view taken on line 5-5 of FIG. 2; and, FIG. 6 is a cross-sectional view taken on line 6-6 of FIG. 2.

The fragmentary broken line representations of a bathroom wall in FIG. 1 and of openings in FIGS. 1, 2 and 6 are for the purpose of illustration only and form no part of the claimed design.

References Cited

U.S. PATENT DOCUMENTS

D. 98,227	1/1936	Callahan	D23/294
D. 260,678	9/1981	Hiller	D23/294 X
D. 261,929	11/1981	Primault	D23/292
D. 293,930	1/1988	Reid	.	
D. 295,071	4/1988	Kohler, Jr.	D23/294
D. 296,923	7/1988	Brossardt et al.	D23/294
D. 314,612	2/1991	Sauter et al.	.	
D. 319,690	9/1991	Reid	D23/294
D. 325,626	4/1992	Ragonot	D23/292
D. 328,338	7/1992	Ragonot	D23/284
510,021	12/1893	Hodge	4/693
834,266	10/1906	Coxon	4/619

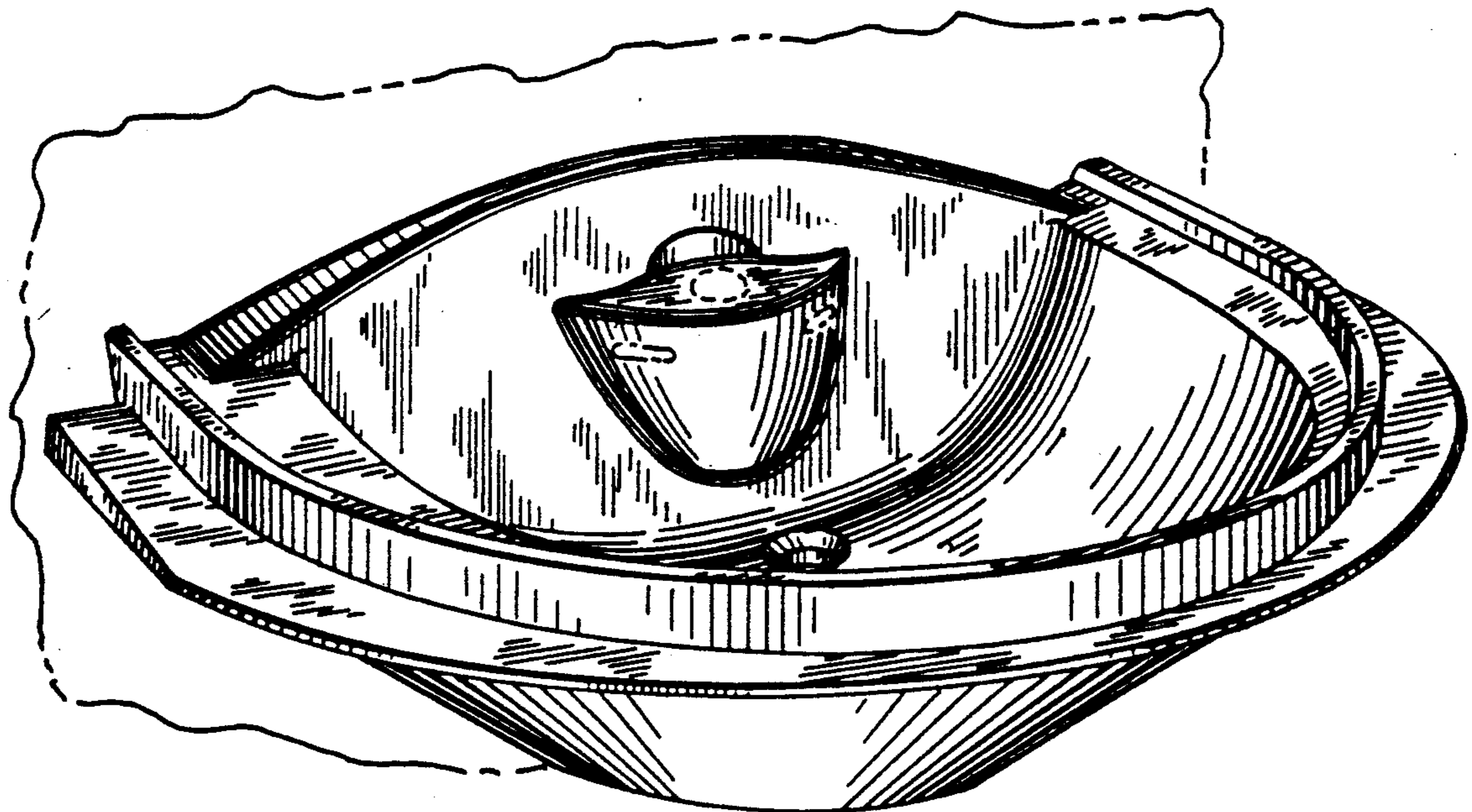

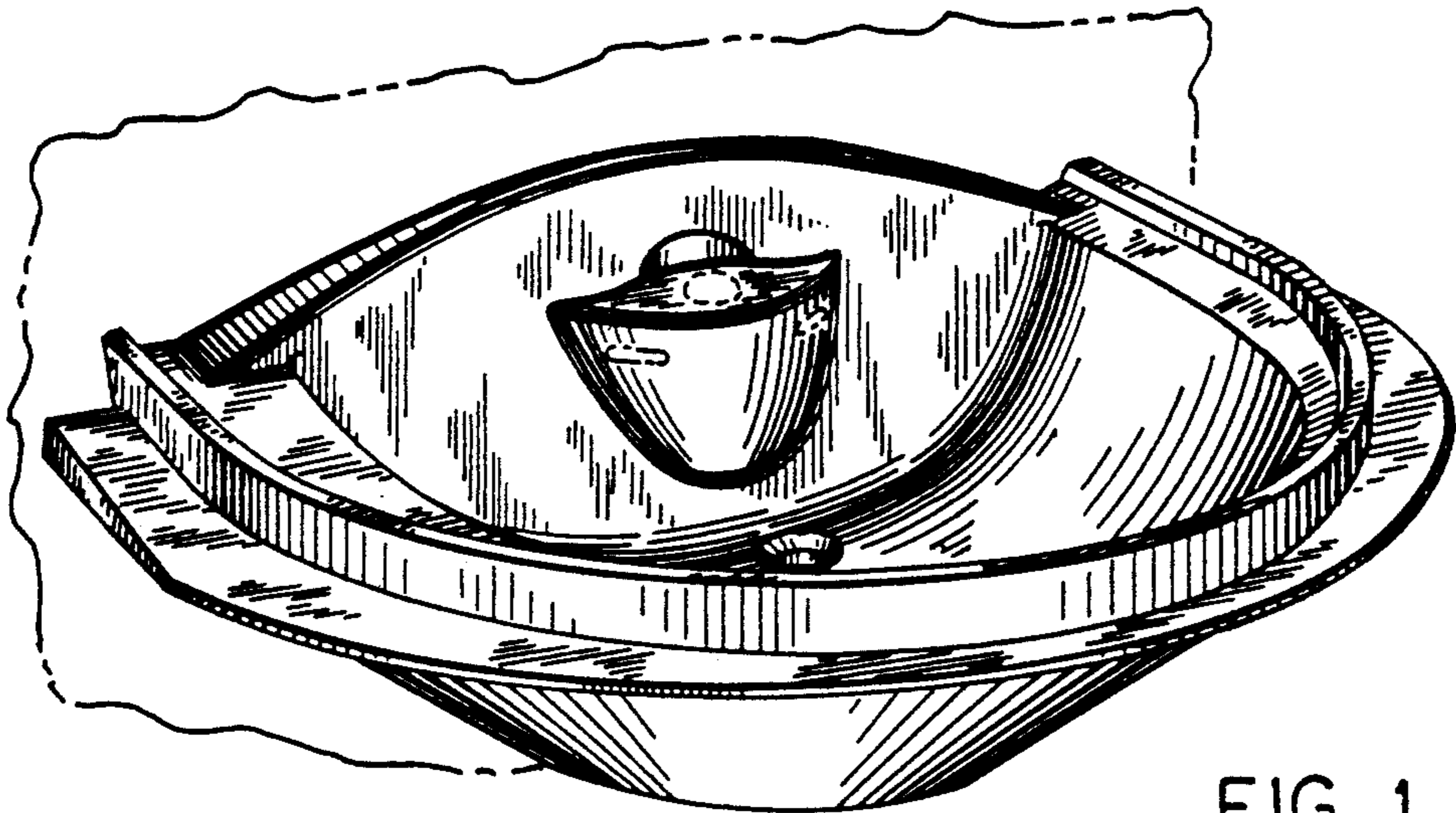

FIG. 1

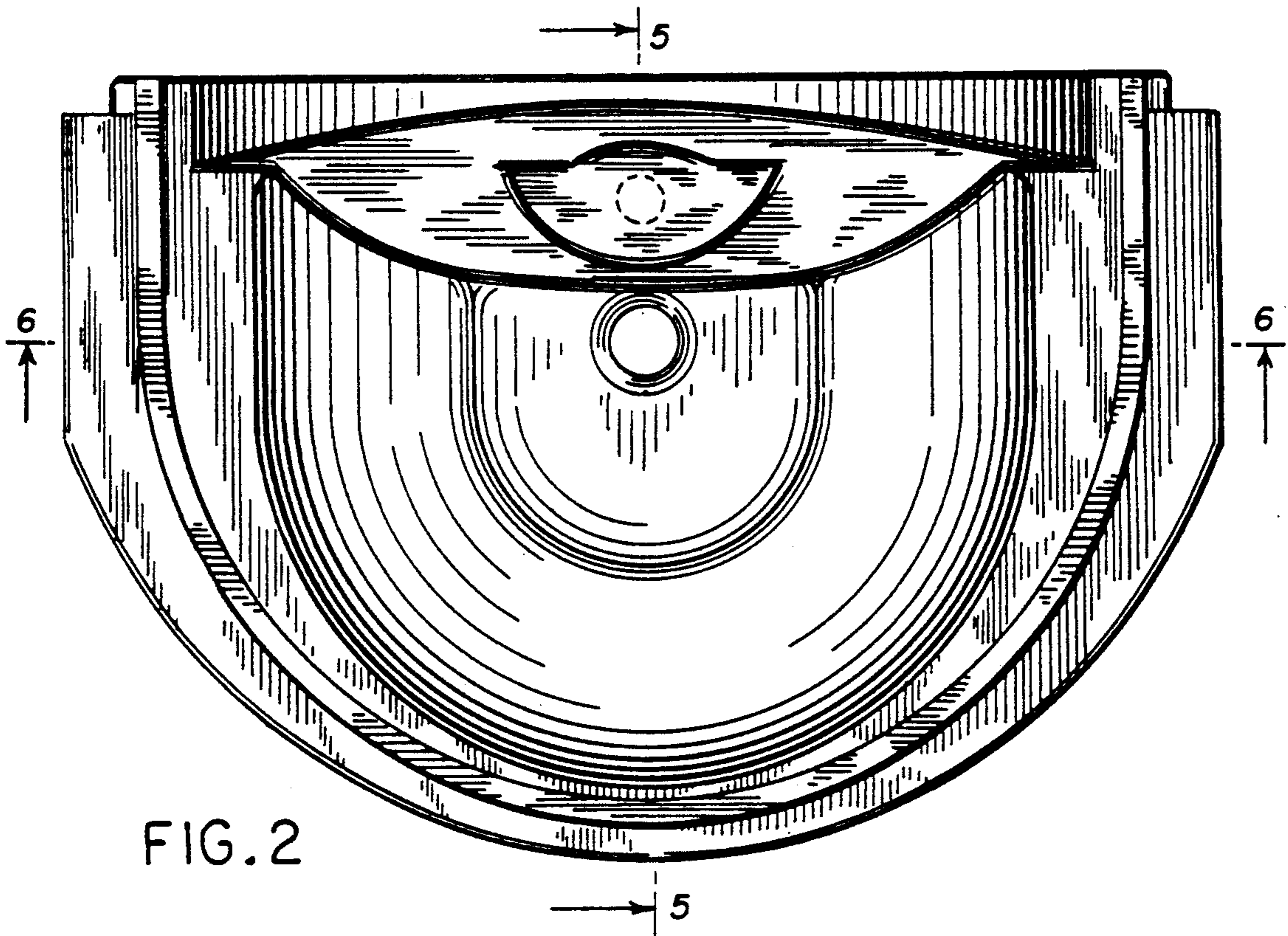

FIG. 2

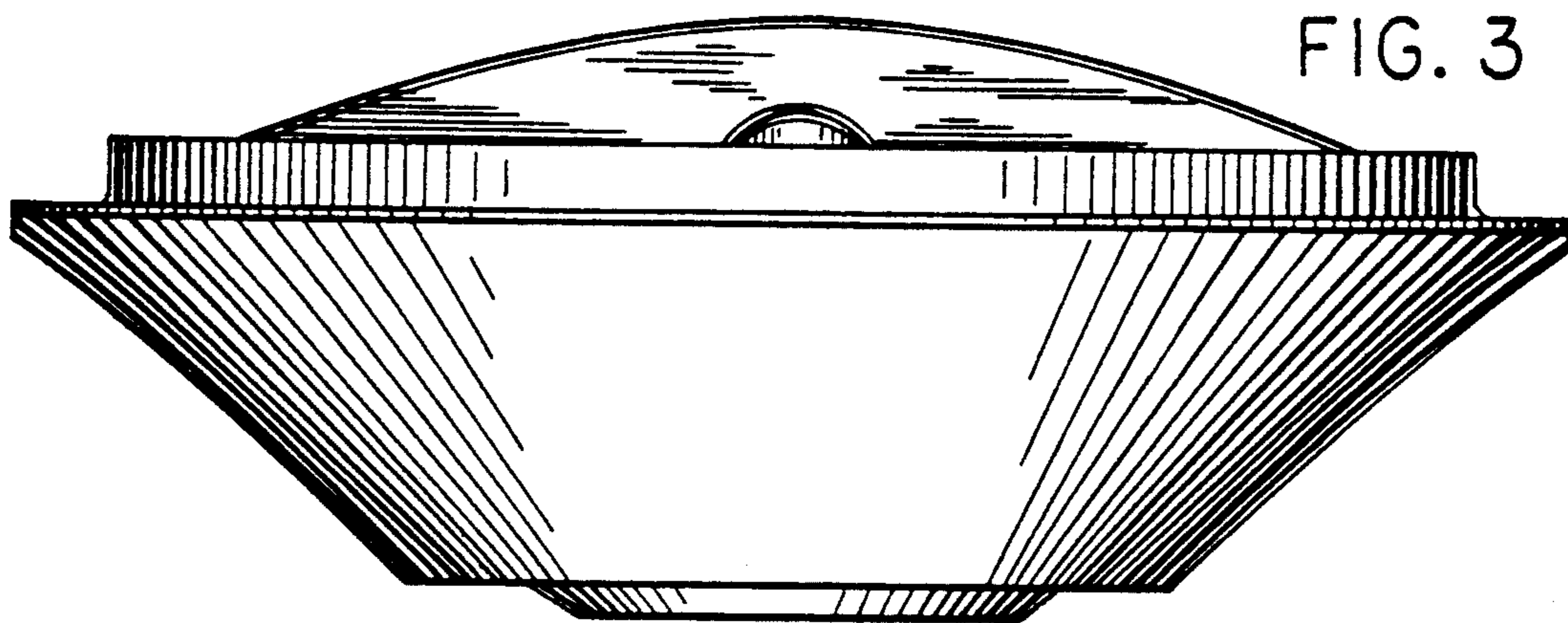

FIG. 3

FIG. 5

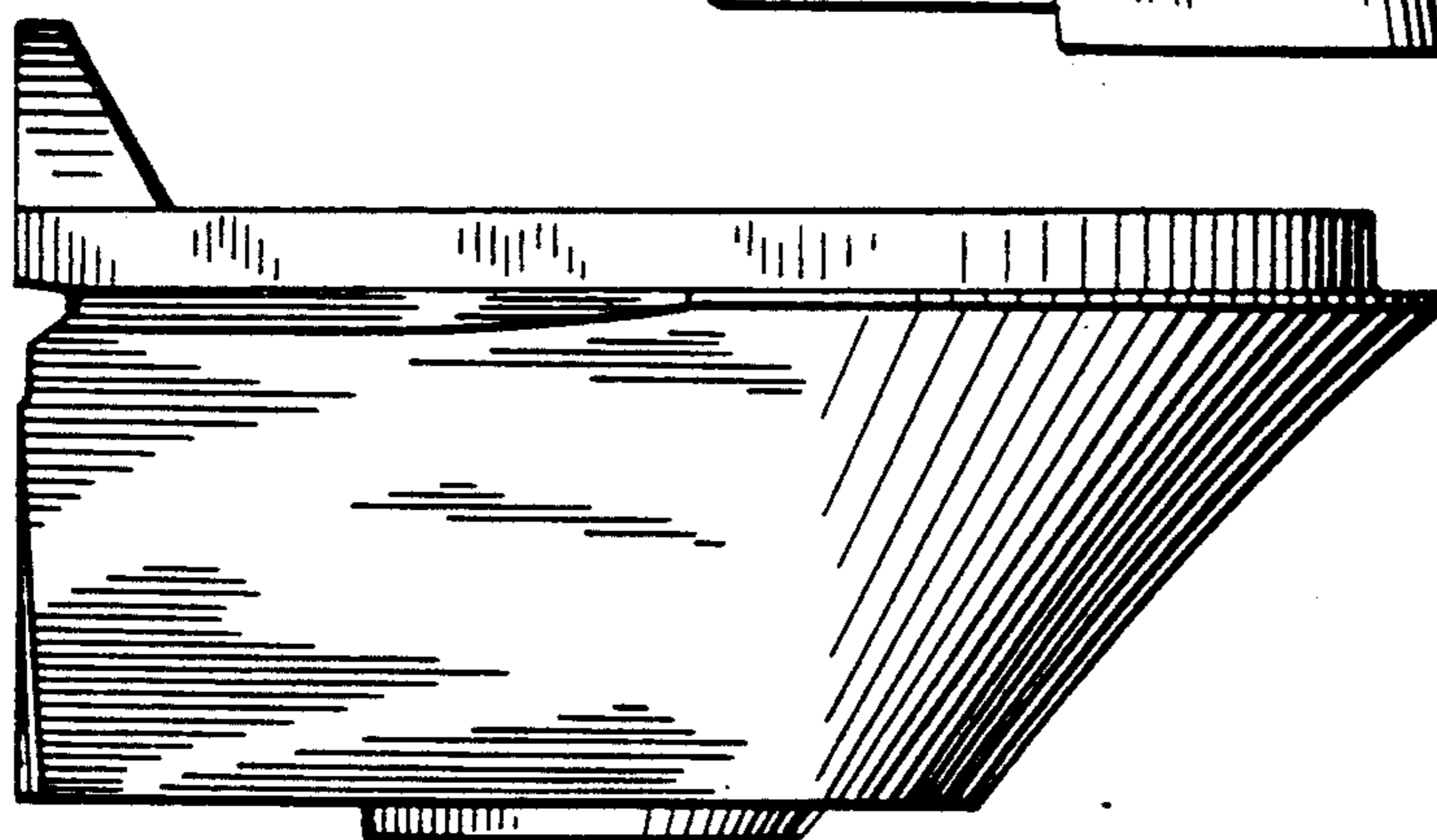
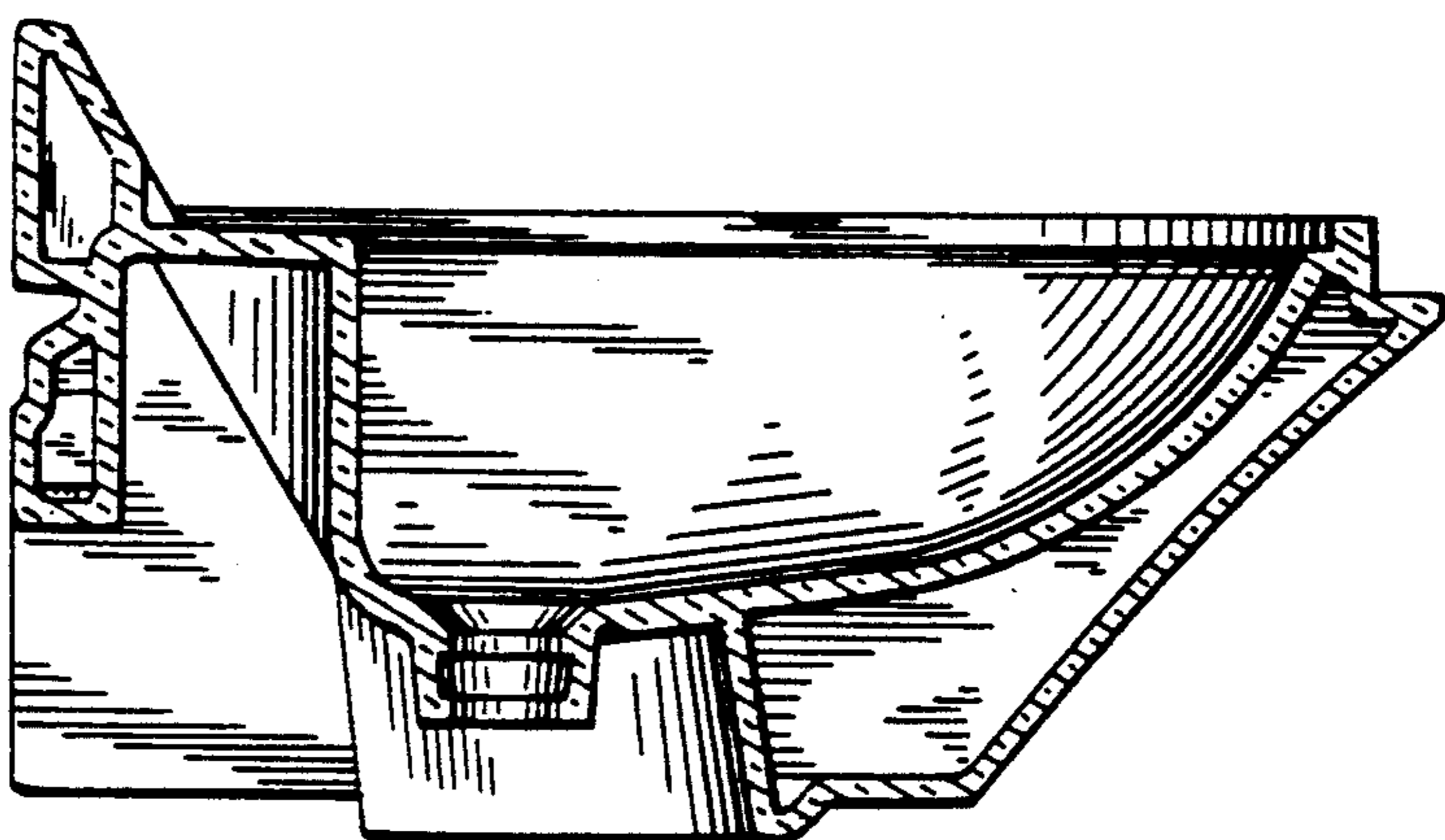

FIG. 4

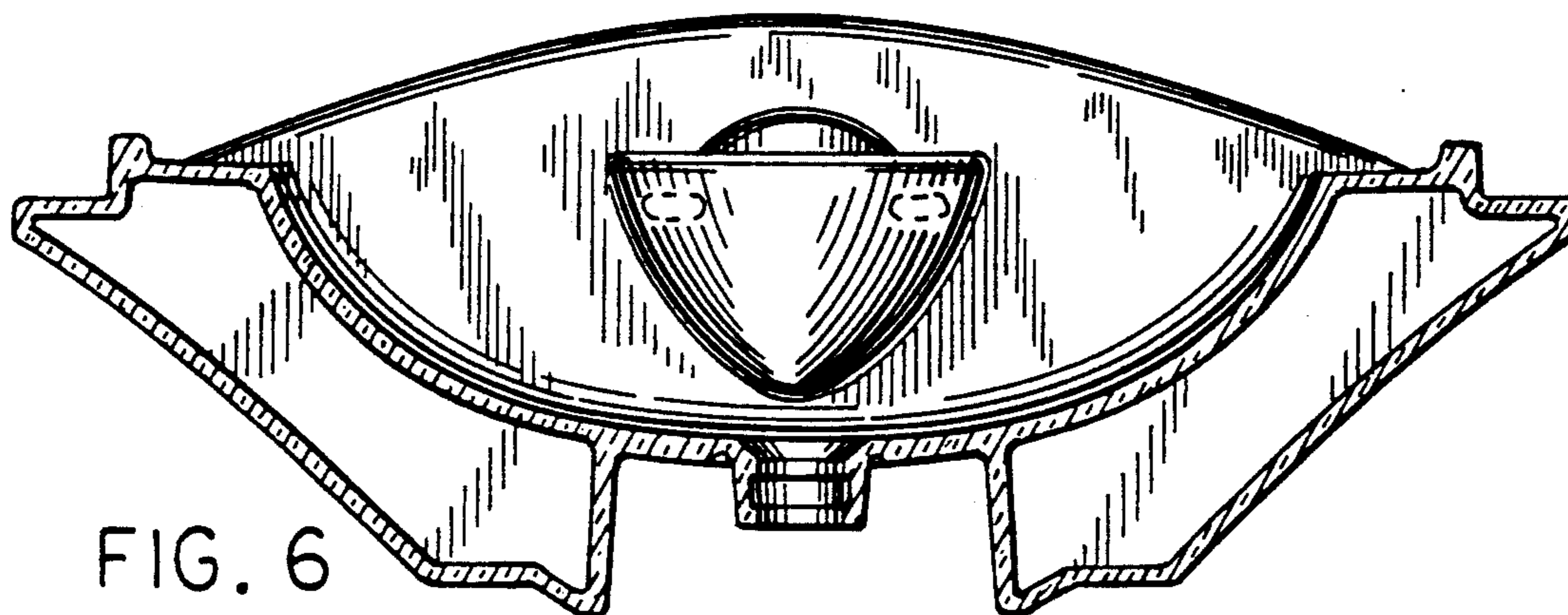

FIG. 6