



US00D340477S

United States Patent [19]

[11] Patent Number: **Des. 340,477**

Regnault

[45] Date of Patent: **** Oct. 19, 1993**

[54] **BALL-POINT PEN TIP**

[75] Inventor: **Pierre Regnault, Valence, France**

[73] Assignee: **Regnault Reynolds S.A., Valence, France**

[**] Term: **14 Years**

[21] Appl. No.: **857,299**

[22] Filed: **Mar. 25, 1992**

[30] **Foreign Application Priority Data**

Oct. 21, 1991 [FR] France 916559

[52] U.S. Cl. **D19/55; D19/51; D19/54**

[58] Field of Search **D19/35, 36, 41-51, D19/54-58, 81-85; 401/209, 258**

[56] **References Cited**

U.S. PATENT DOCUMENTS

D. 28,838	6/1898	Fairchild	D19/48
D. 130,436	11/1941	Nissen, Jr.	D19/55
D. 157,918	3/1950	Stewart	D19/55
D. 196,993	11/1963	Green	D19/51 X
D. 333,152	2/1993	Anavil et al.	D19/51 X
2,956,298	10/1960	Jagtenberg	401/209 X
3,729,269	4/1973	Koeln	401/209
3,977,798	8/1976	Kuparinen	D19/41 X
4,145,148	3/1979	Fukuoka	401/209
4,311,403	1/1982	Liguori	401/209
4,789,263	12/1988	Germann	401/209

FOREIGN PATENT DOCUMENTS

635692	4/1950	United Kingdom	D19/54
772321	4/1957	United Kingdom	D19/54

Primary Examiner—Nelson C. Holtje
Assistant Examiner—Martha Thompson
Attorney, Agent, or Firm—Finnegan, Henderson, Farabow, Garrett & Dunner

[57] **CLAIM**

The ornamental design for a ball-point pen tip, as shown and described.

DESCRIPTION

FIG. 1 is a side elevational view of a ball-point pen tip showing my new design, all other sides being identical thereto;
 FIG. 2 is an enlarged, fragmentary side elevational view of the head portion;
 FIG. 3 is a top plan view of FIG. 1;
 FIG. 4 is a bottom plan view of FIG. 1;
 FIG. 5 is a longitudinal cross-sectional view of FIG. 1;
 FIG. 6 is a perspective view of FIG. 1;
 FIG. 7 is a side elevational view of a second embodiment of my new design, all other sides being identical thereto;
 FIG. 8 is an enlarged, fragmentary side elevational view of the head portion;
 FIG. 9 is a top plan view of FIG. 7;
 FIG. 10 is a bottom plan view of FIG. 7;
 FIG. 11 is a longitudinal cross-sectional view of FIG. 7;
 and,
 FIG. 12 is a perspective view of FIG. 7.

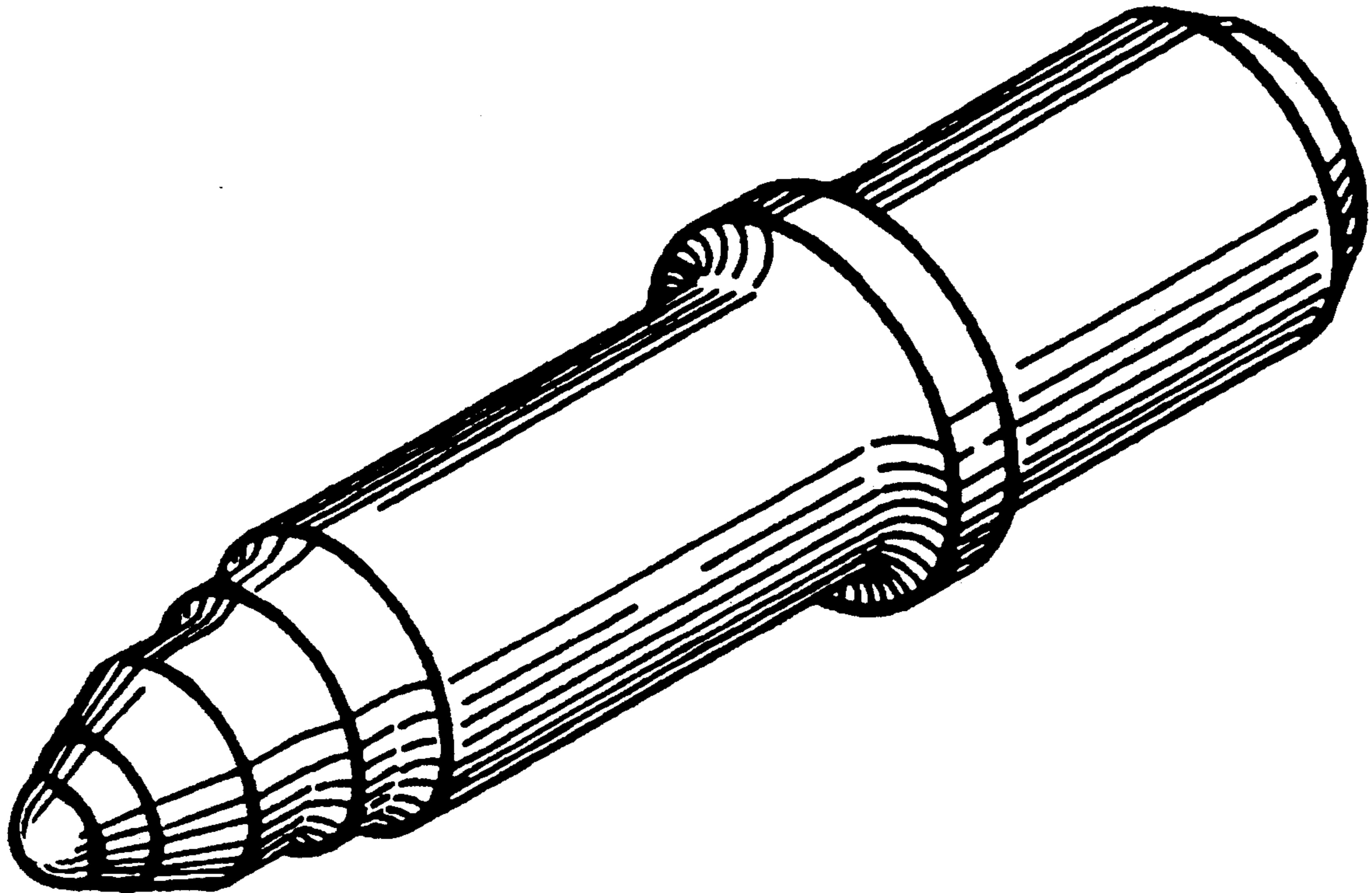

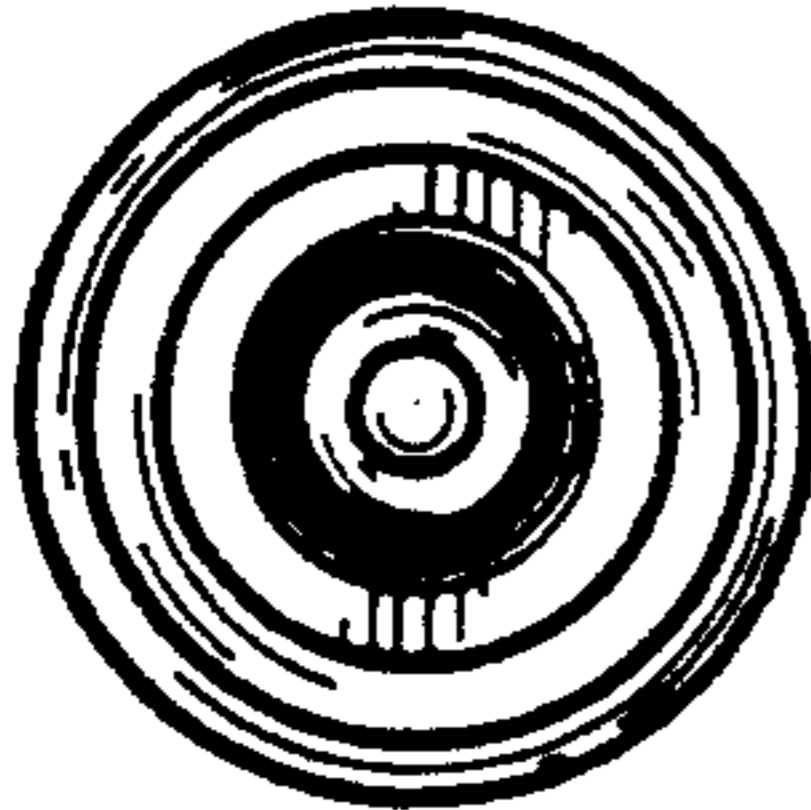

FIG. 3

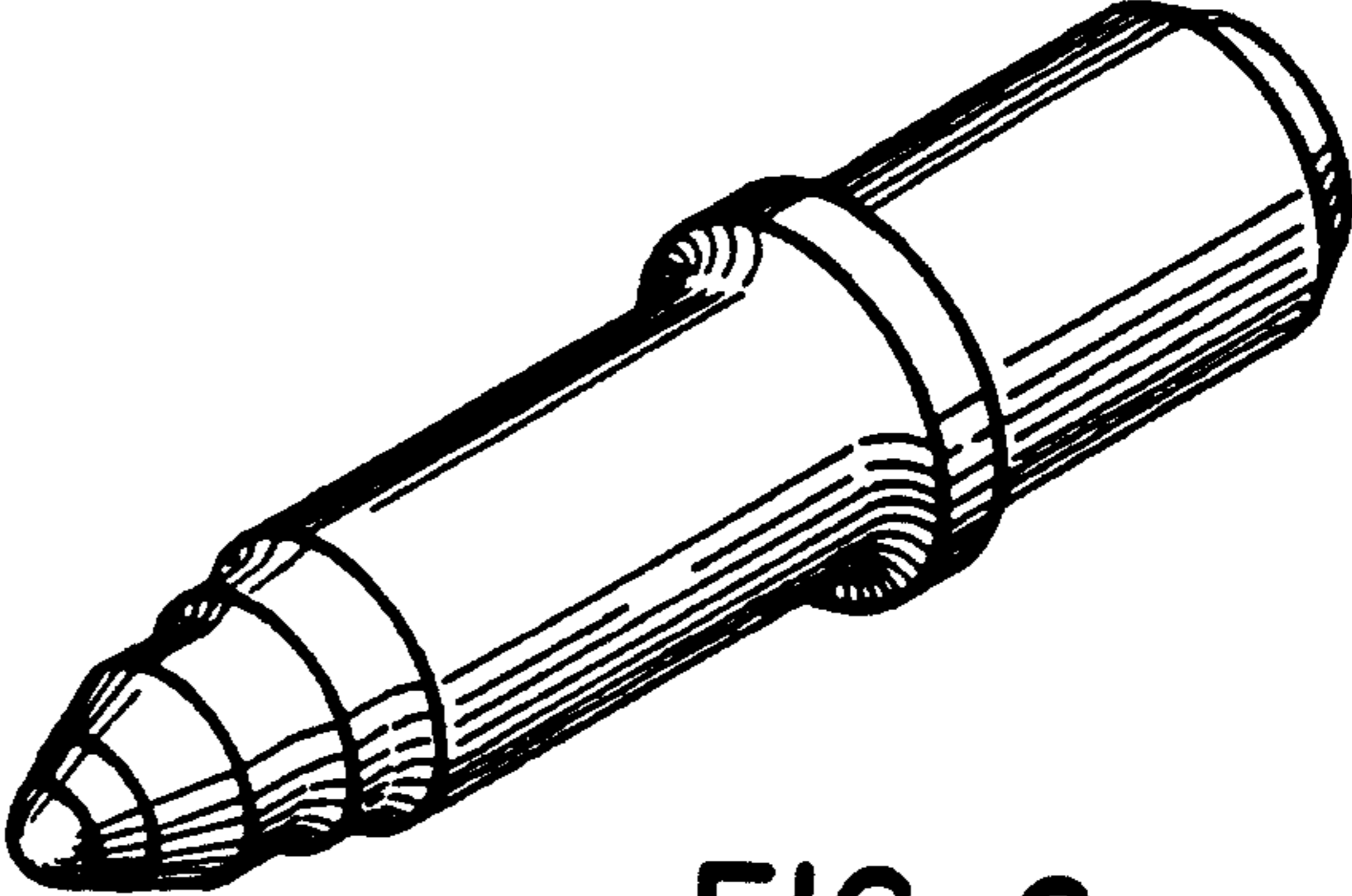

FIG. 6

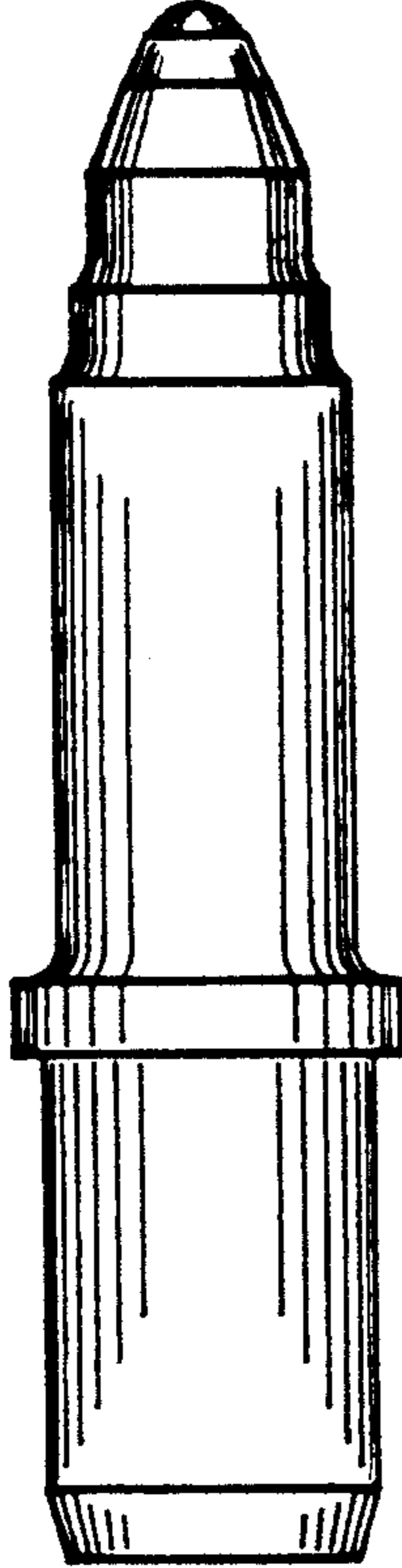

FIG. 1

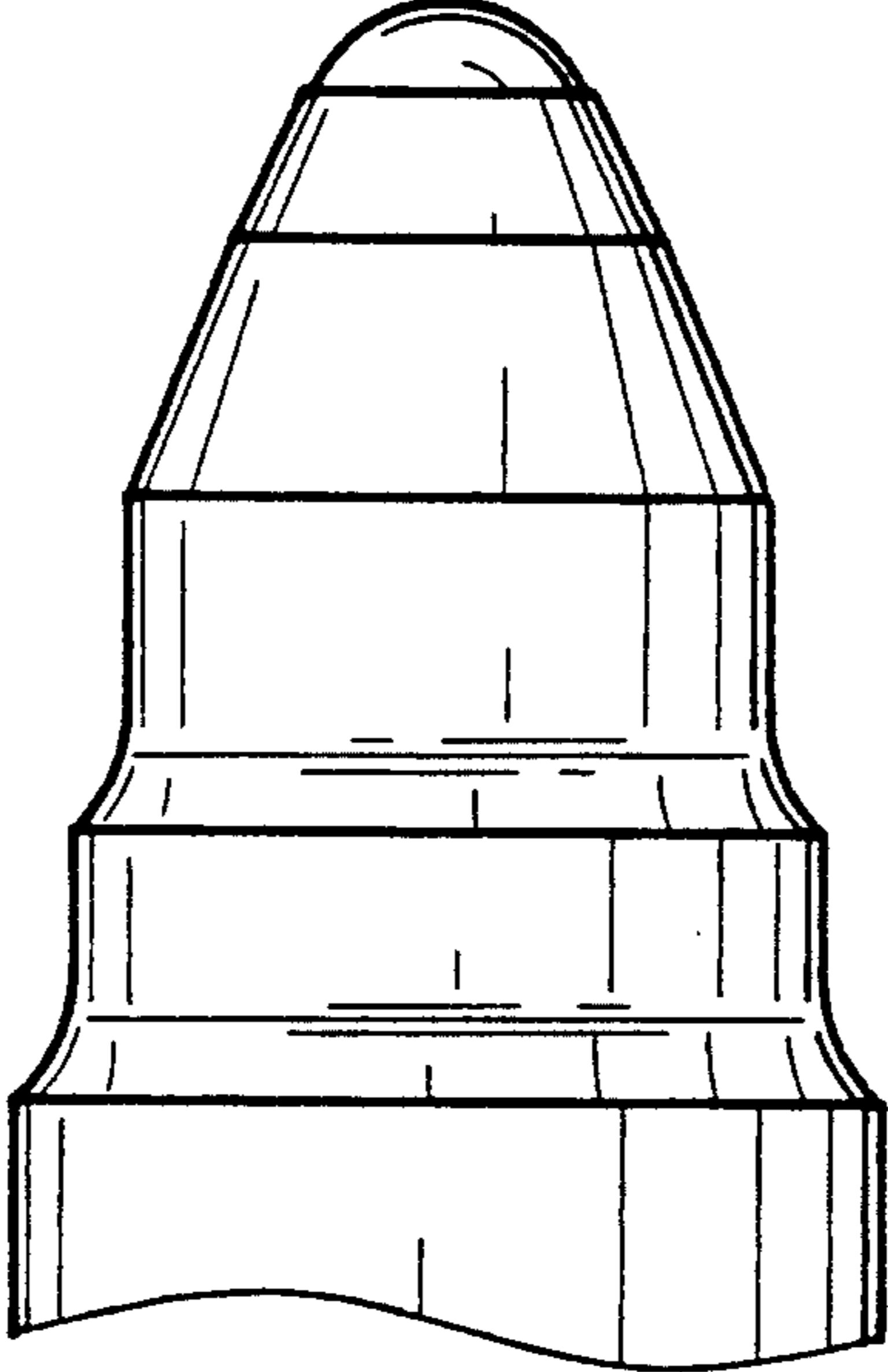

FIG. 2

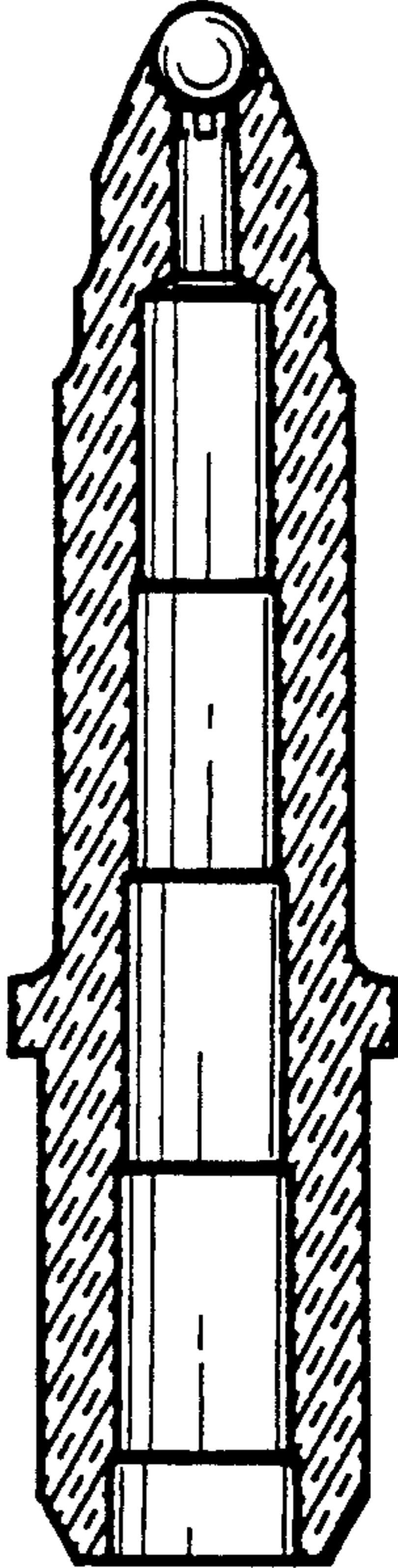

FIG. 5

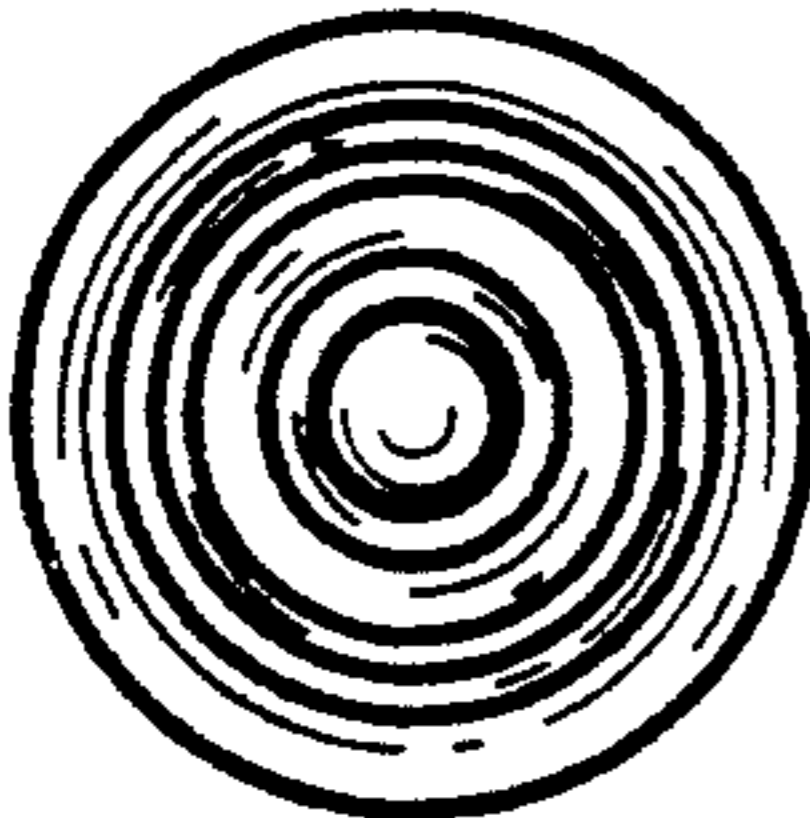

FIG. 4

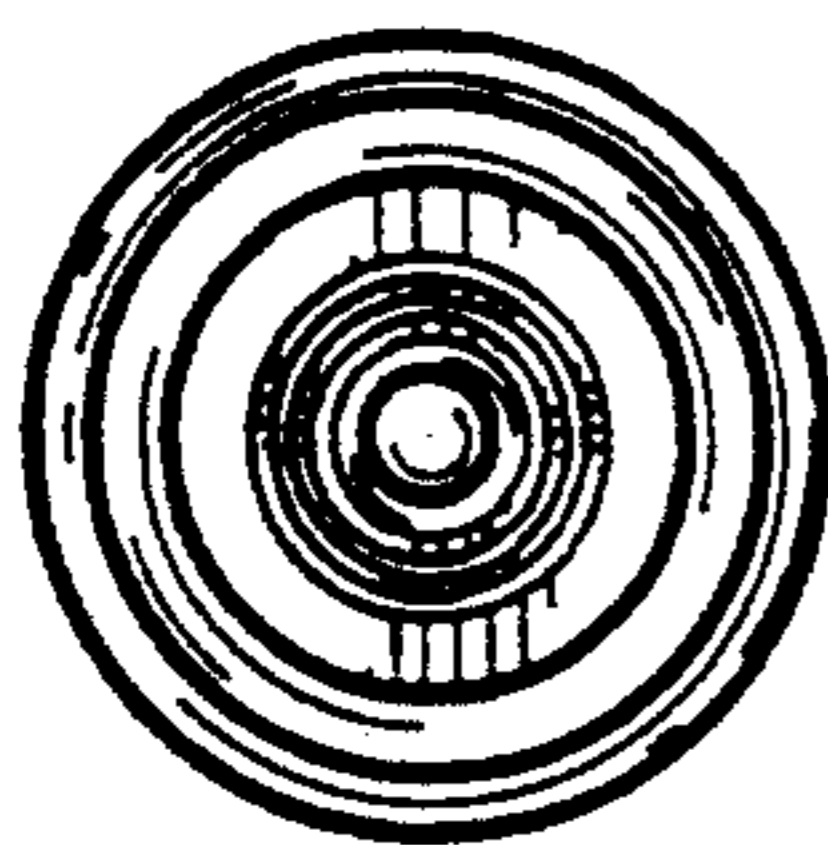

FIG. 9

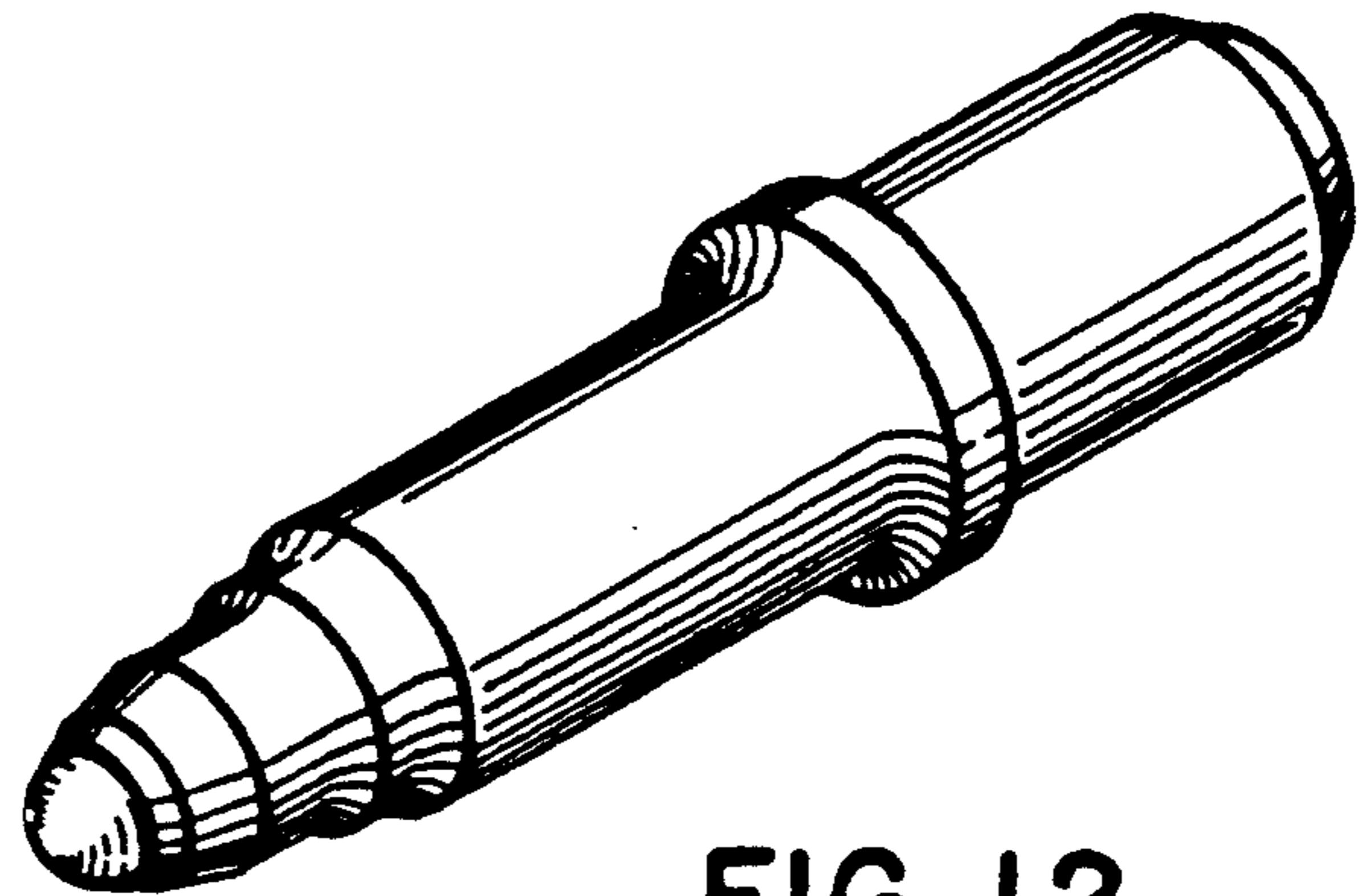

FIG. 12

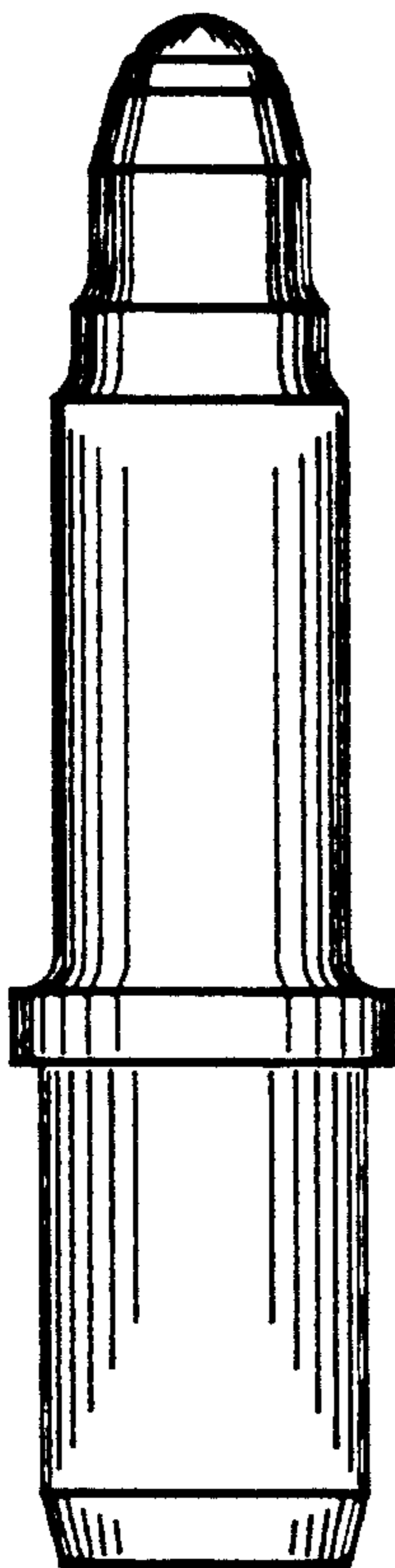

FIG. 7

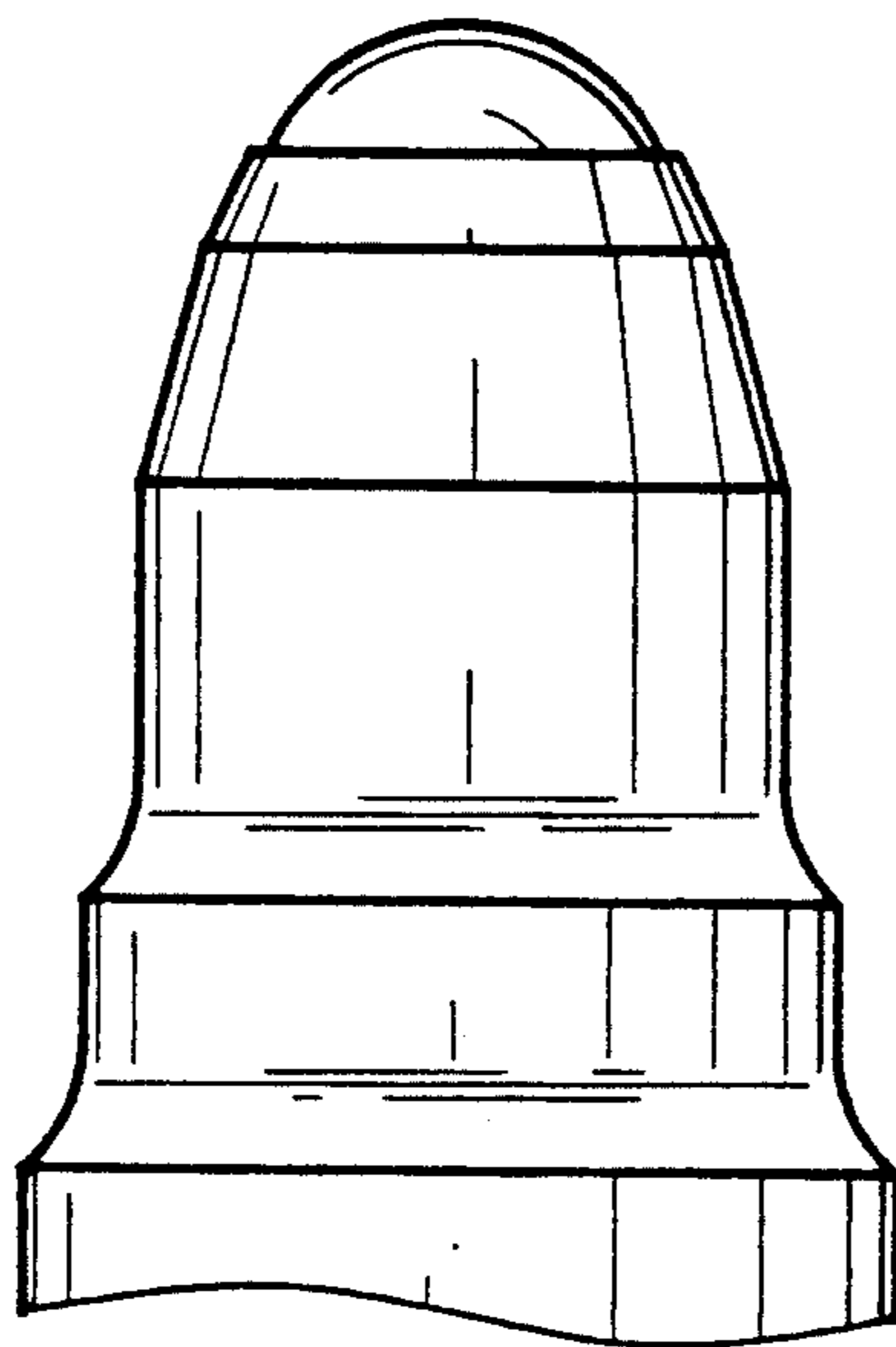

FIG. 8

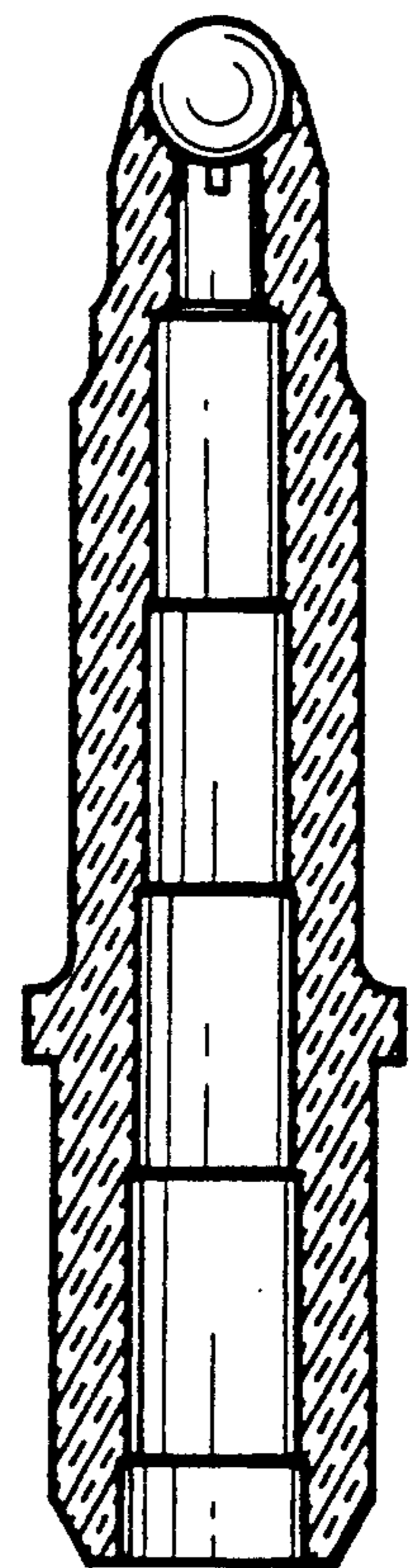

FIG. 11

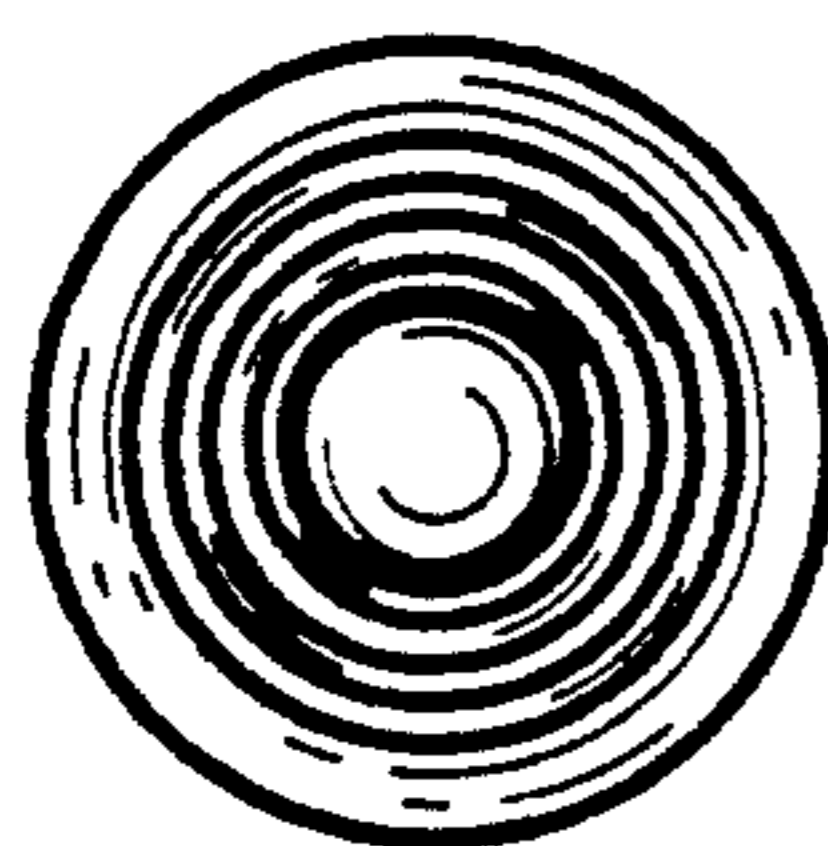

FIG. 10