



US00D340375S

United States Patent [19]

[11] Patent Number: **Des. 340,375**

Hines

[45] Date of Patent: **** Oct. 19, 1993**

[54] **TOILET TISSUE DISPENSER**

[75] Inventor: **David M. Hines, Santa Ana, Calif.**

[73] Assignee: **Bobrick Washroom Equipment, Inc., North Hollywood, Calif.**

[**] Term: **14 Years**

[21] Appl. No.: **2,996**

[22] Filed: **Dec. 28, 1992**

[52] U.S. Cl. **D6/523**

[58] Field of Search **D6/515, 517-518, D6/522-523; 312/34.8, 42, 50; 221/33, 45, 48, 55, 282-286; 242/55.2, 55.3, 55.53; 4/252.3**

4,558,472 12/1985 Fromme et al. 4/252.3
4,882,161 2/1987 Payne, Jr. et al. D6/522

Primary Examiner—Brian N. Vinson
Attorney, Agent, or Firm—Harris, Kern, Wallen & Tinsley

[57] **CLAIM**

The ornamental design for a toilet tissue dispenser, as shown and described.

DESCRIPTION

FIG. 1 is a top, front, and left side perspective view of a toilet tissue dispenser showing my new design, the broken-line disclosure of a portion of a wall being for illustrative purposes only and forming no part of the claimed design;

FIG. 2 is an enlarged front elevational view thereof;

FIG. 3 is an enlarged right side elevational view thereof;

FIG. 4 is an enlarged rear elevational view thereof;

FIG. 5 is an enlarged top plan view thereof;

FIG. 6 is an enlarged bottom plan view thereof;

FIG. 7 is a top, front, and left side perspective view of an alternate embodiment of a toilet tissue dispenser showing my new design, the broken-line disclosure of a portion of a wall being for illustrative purposes only and forming no part of the claimed design;

FIG. 8 is an enlarged front elevational view thereof;

FIG. 9 is an enlarged right side elevational view thereof;

FIG. 10 is an enlarged rear elevational view thereof;

FIG. 11 is an enlarged top plan view thereof; and,

FIG. 12 is an enlarged bottom plan view thereof.

[56] **References Cited**

U.S. PATENT DOCUMENTS

- D. 200,206 2/1965 Arkwright .
- D. 201,042 5/1965 Johannes D6/522
- D. 283,574 4/1986 Bernard D6/522
- D. 285,887 9/1986 Palka D6/559
- D. 286,235 10/1986 Collins D6/522
- D. 286,236 10/1986 Collins D6/522
- D. 292,155 10/1987 Miels D6/523
- D. 293,746 1/1988 Sayward D6/448
- D. 312,179 11/1990 DeLuca et al. D6/518
- 1,686,831 10/1928 Matchette .
- 1,800,826 4/1931 Feltault .
- 2,645,100 7/1953 Bascom .
- 3,226,171 12/1965 Fitzgerald et al. 312/42
- 4,076,350 2/1978 Crist 312/242
- 4,408,811 10/1983 Richardson et al. 312/34.8 X

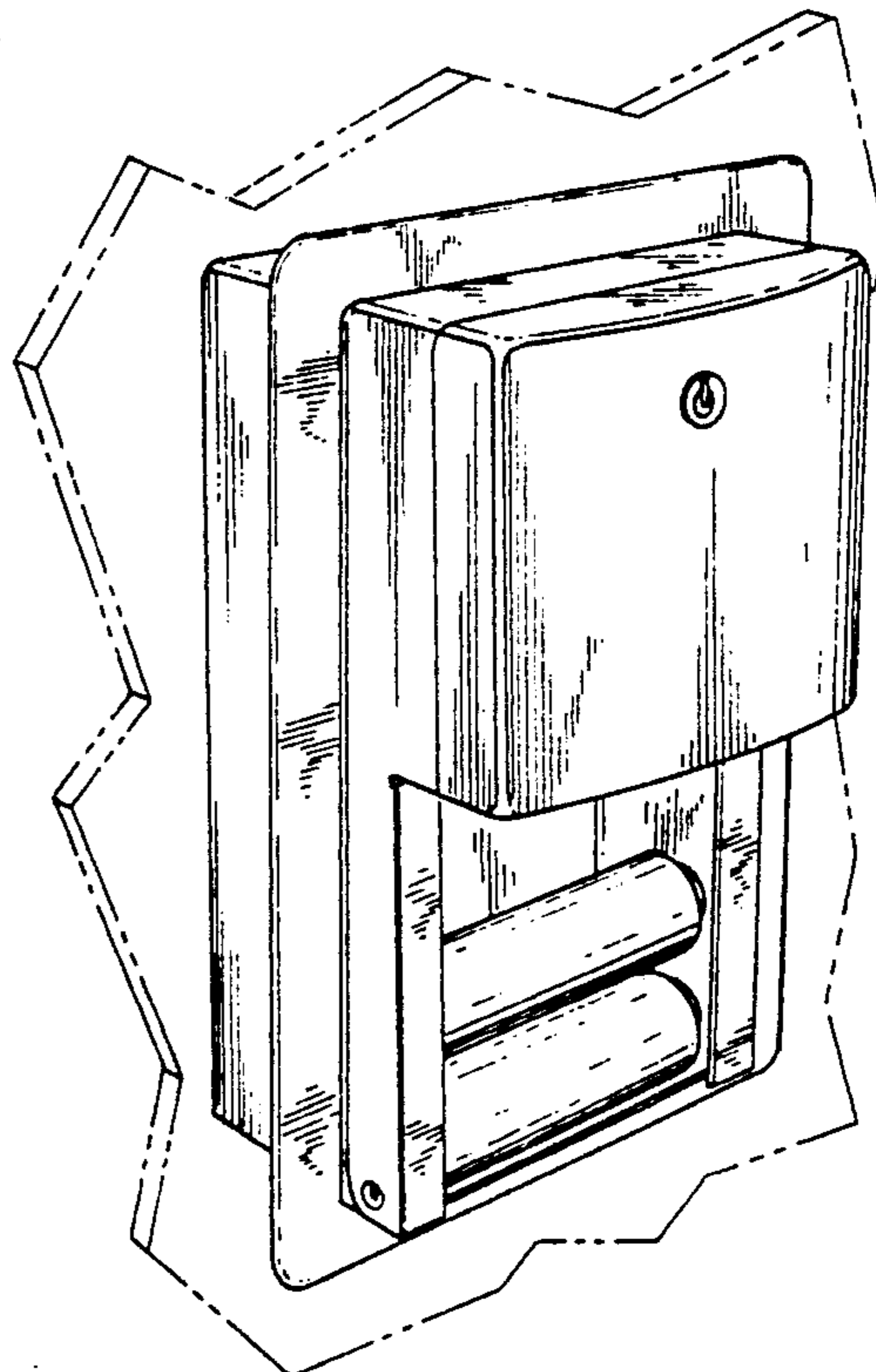
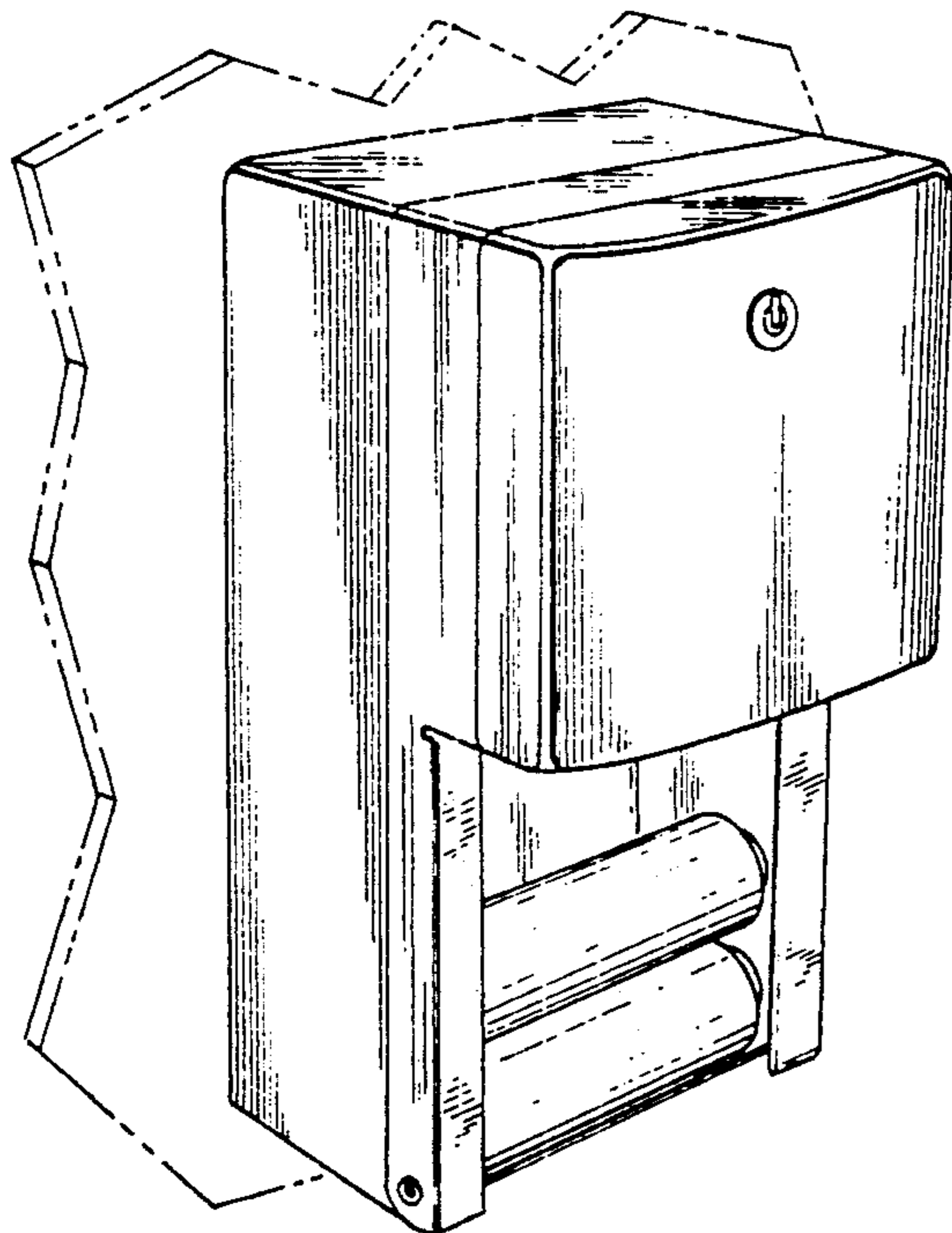

FIG. 1

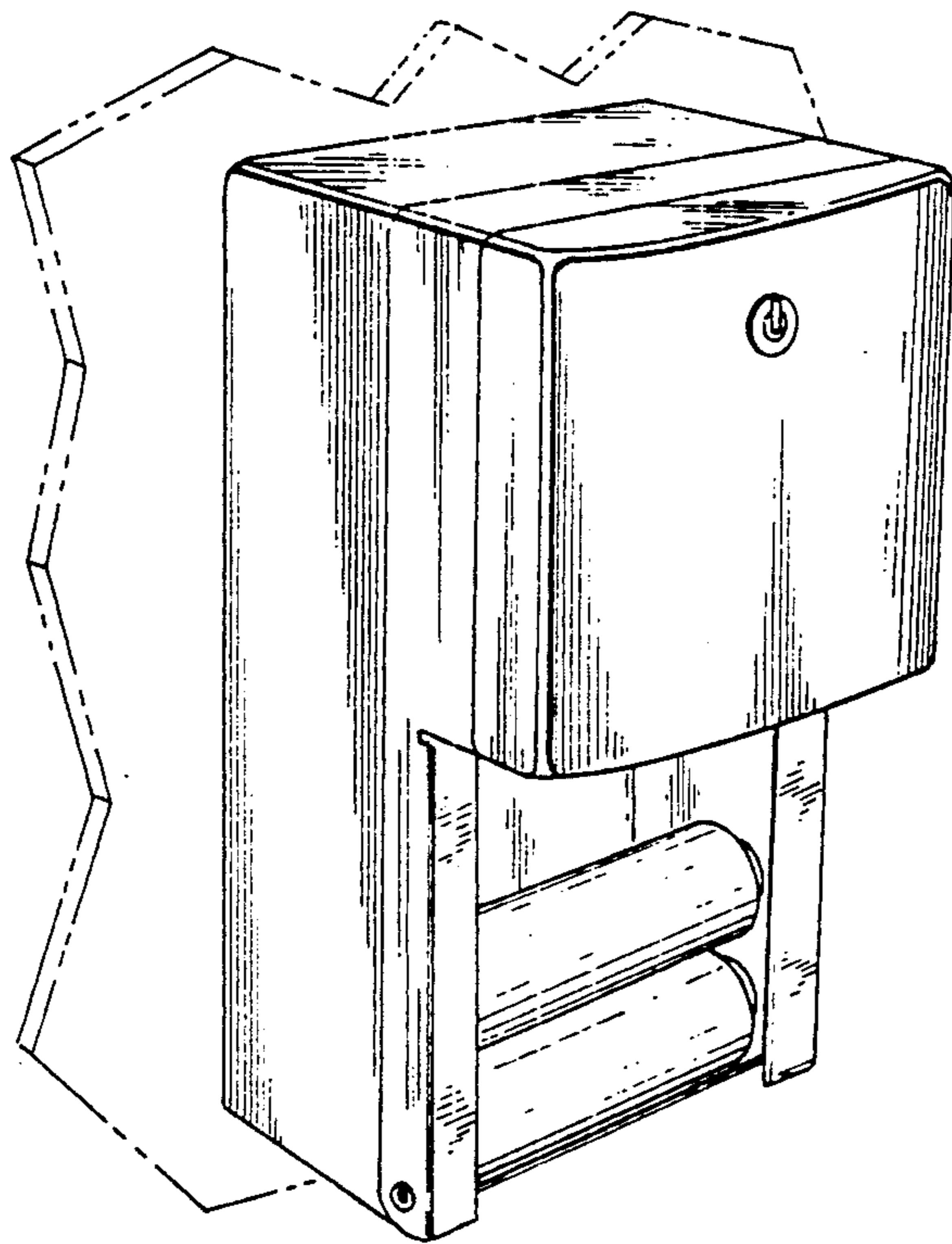

FIG. 2

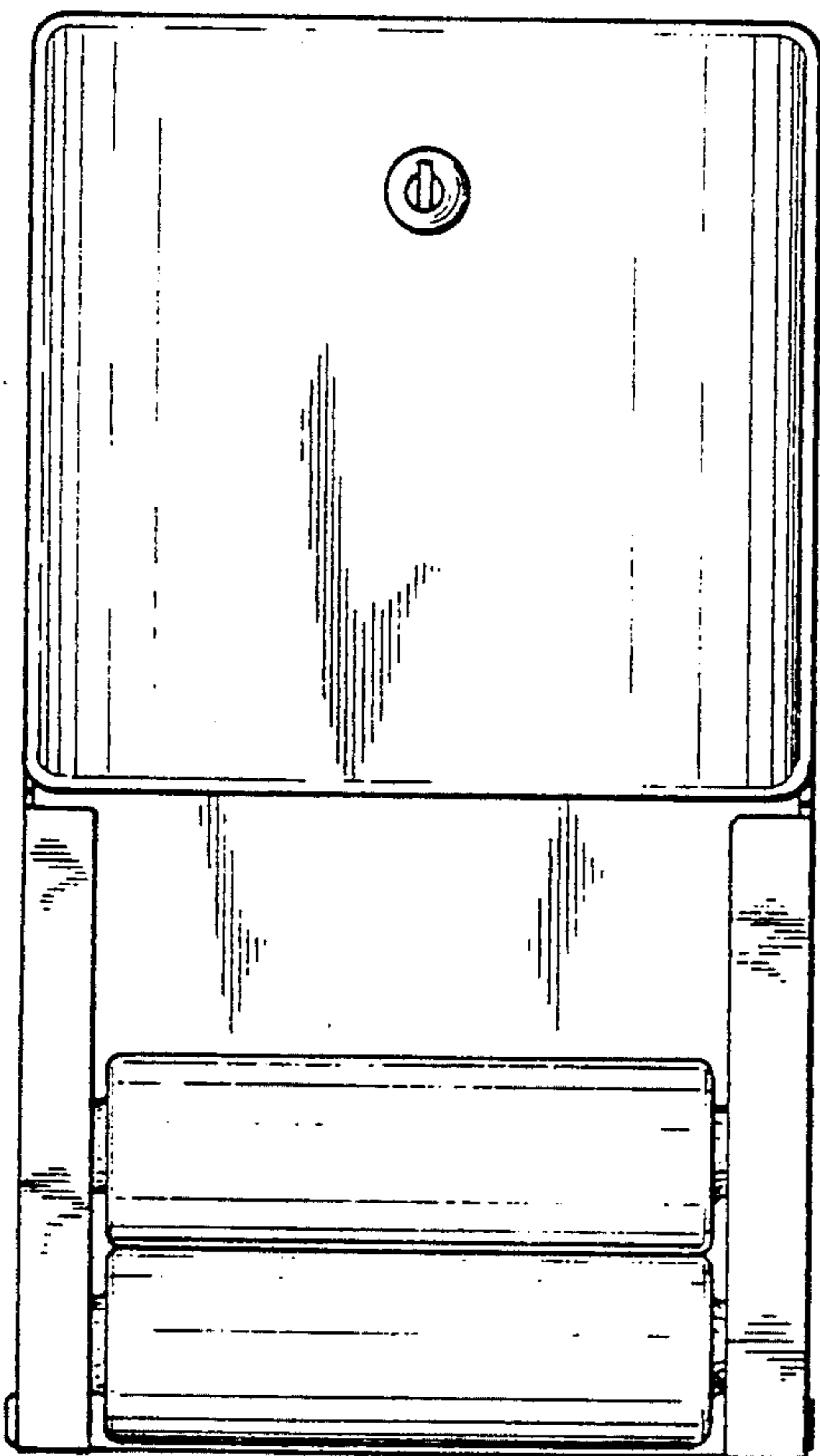

FIG. 3

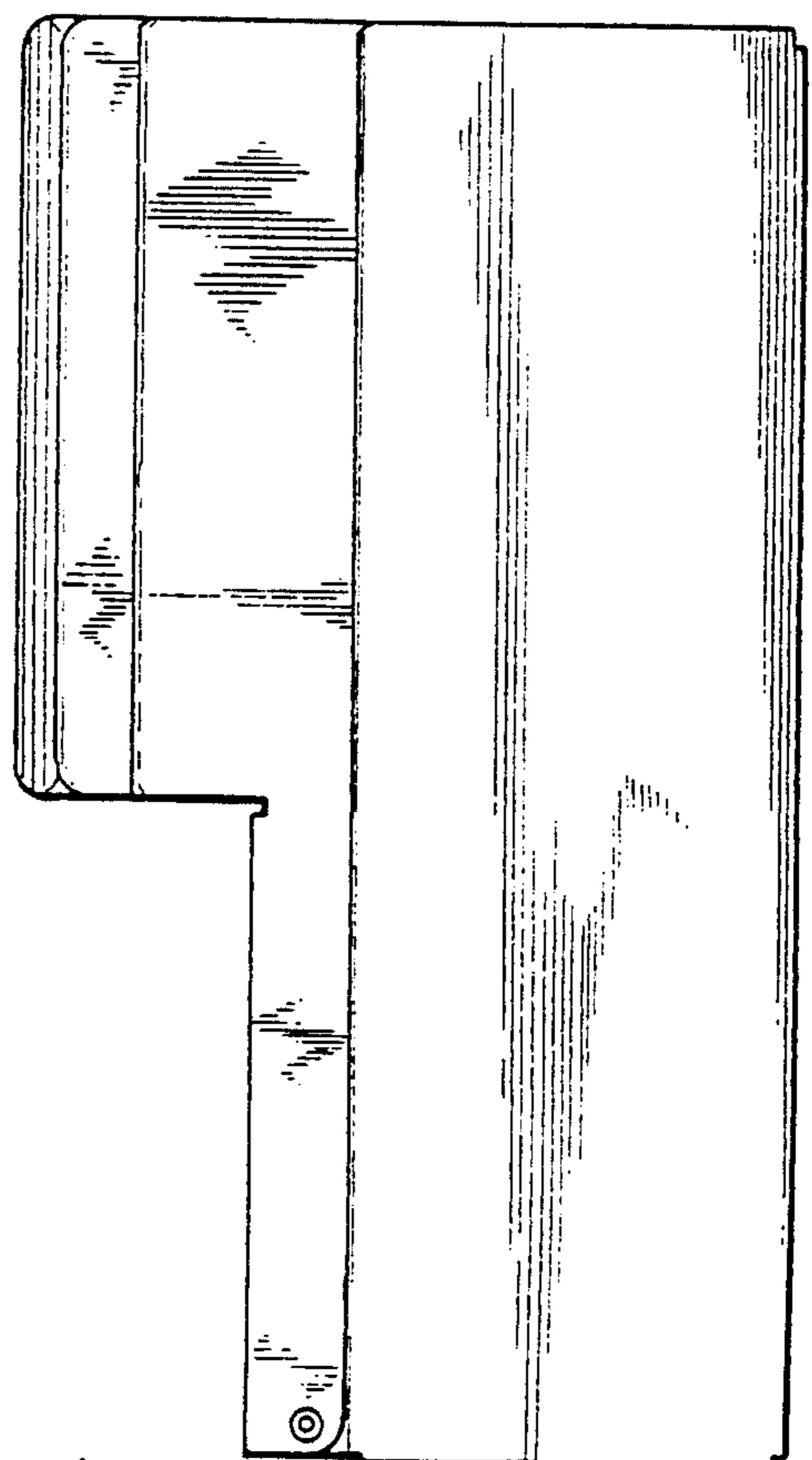

FIG. 5

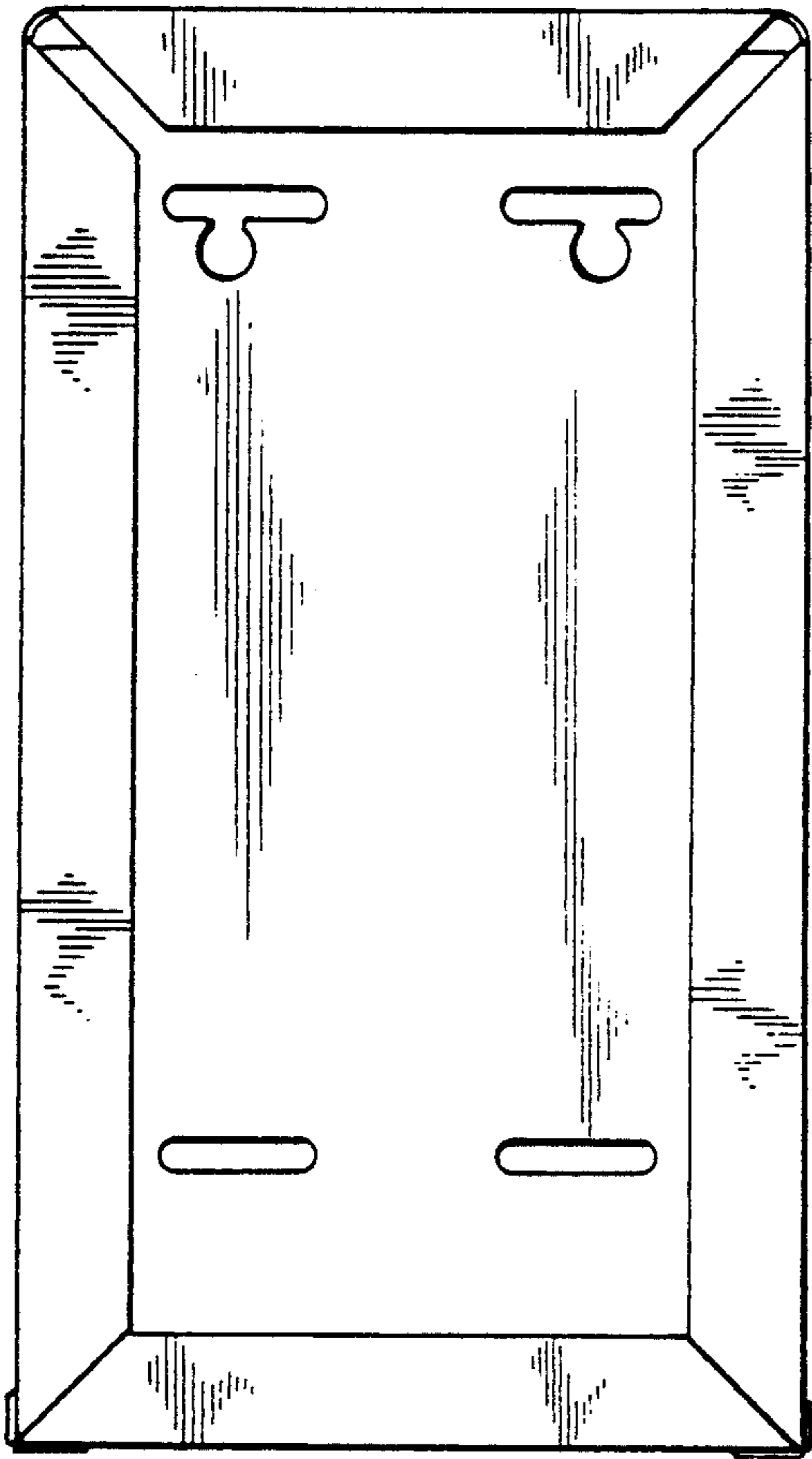
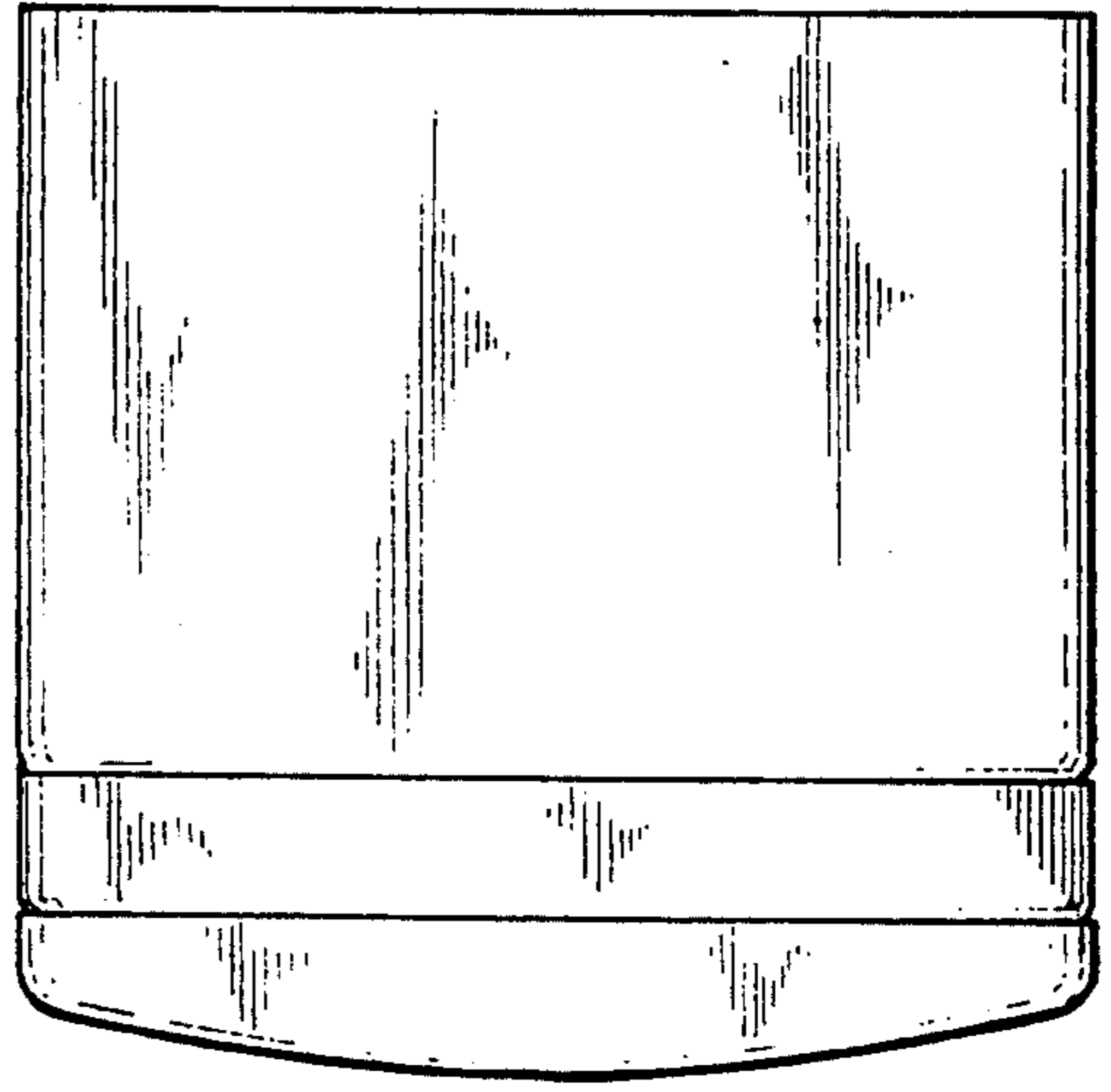

FIG. 4

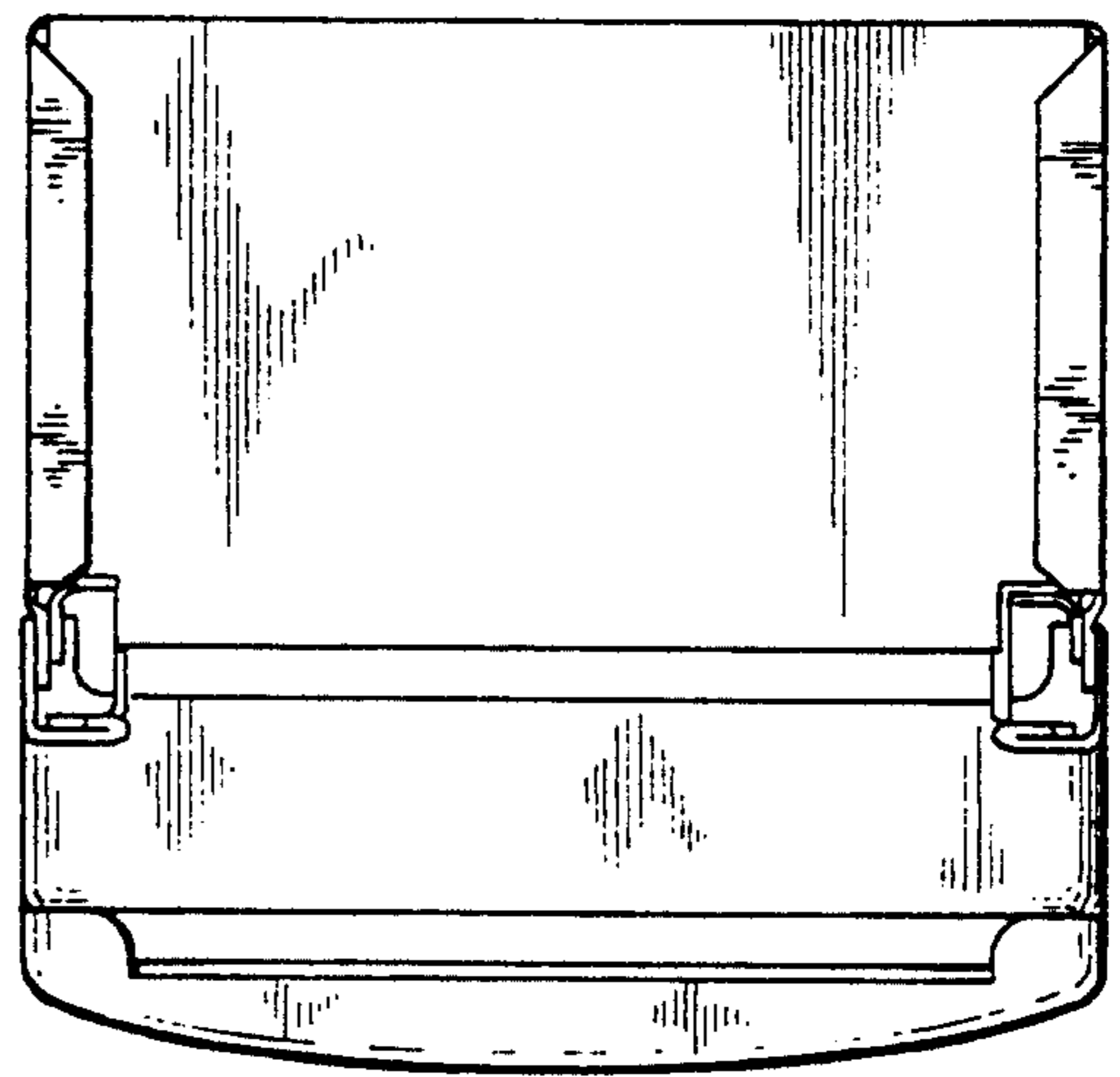

FIG. 6

FIG. 7

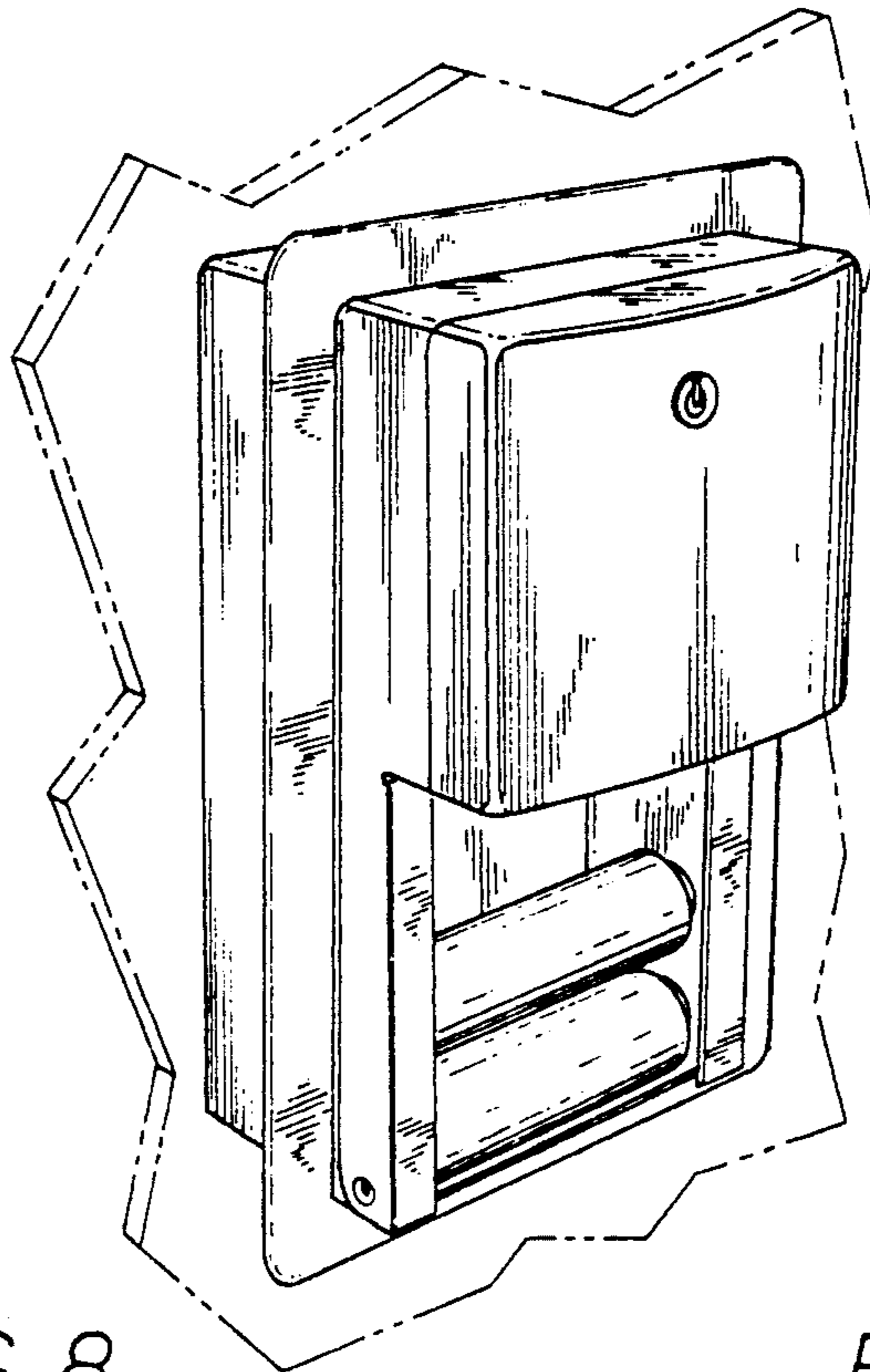

FIG. 8

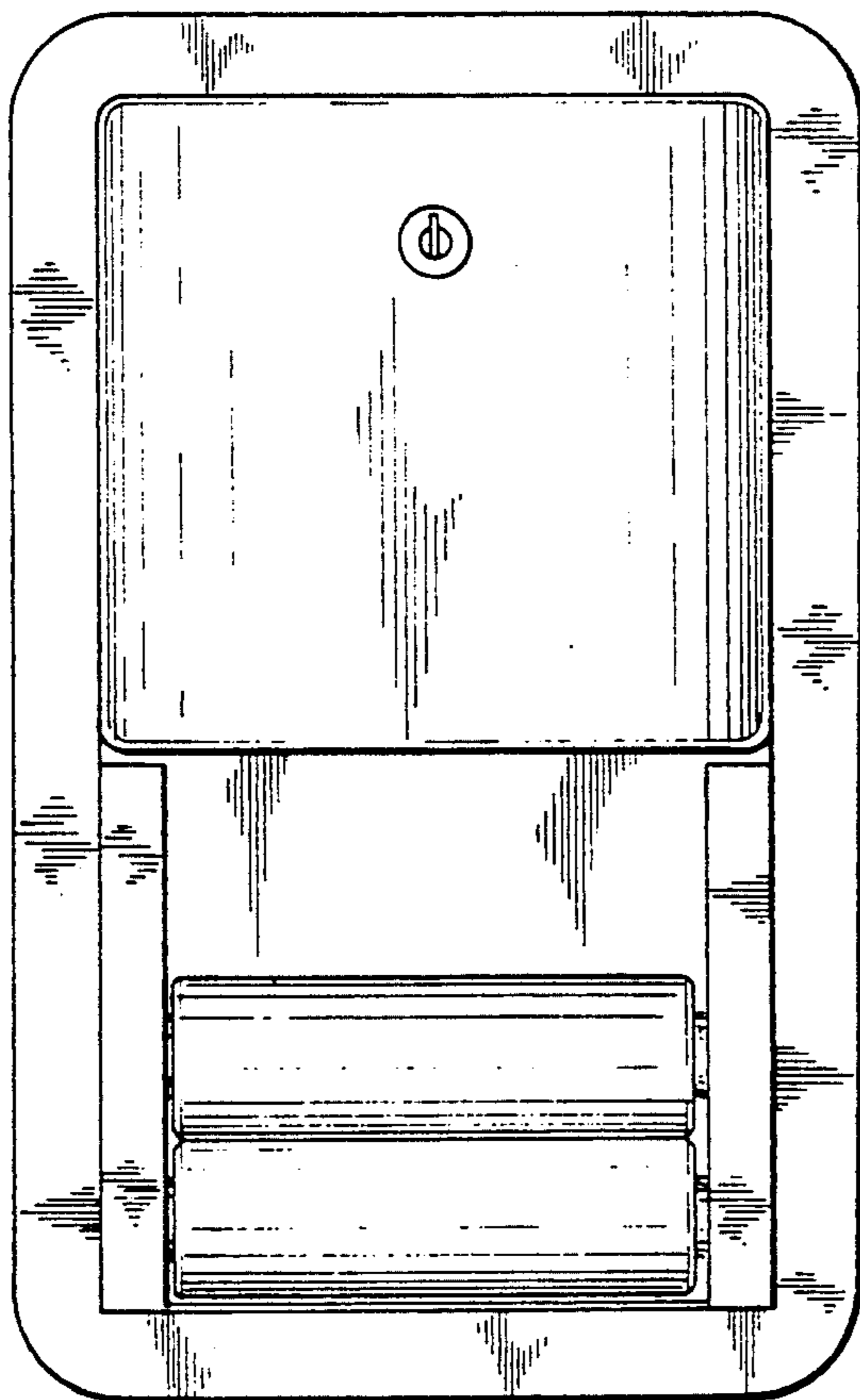
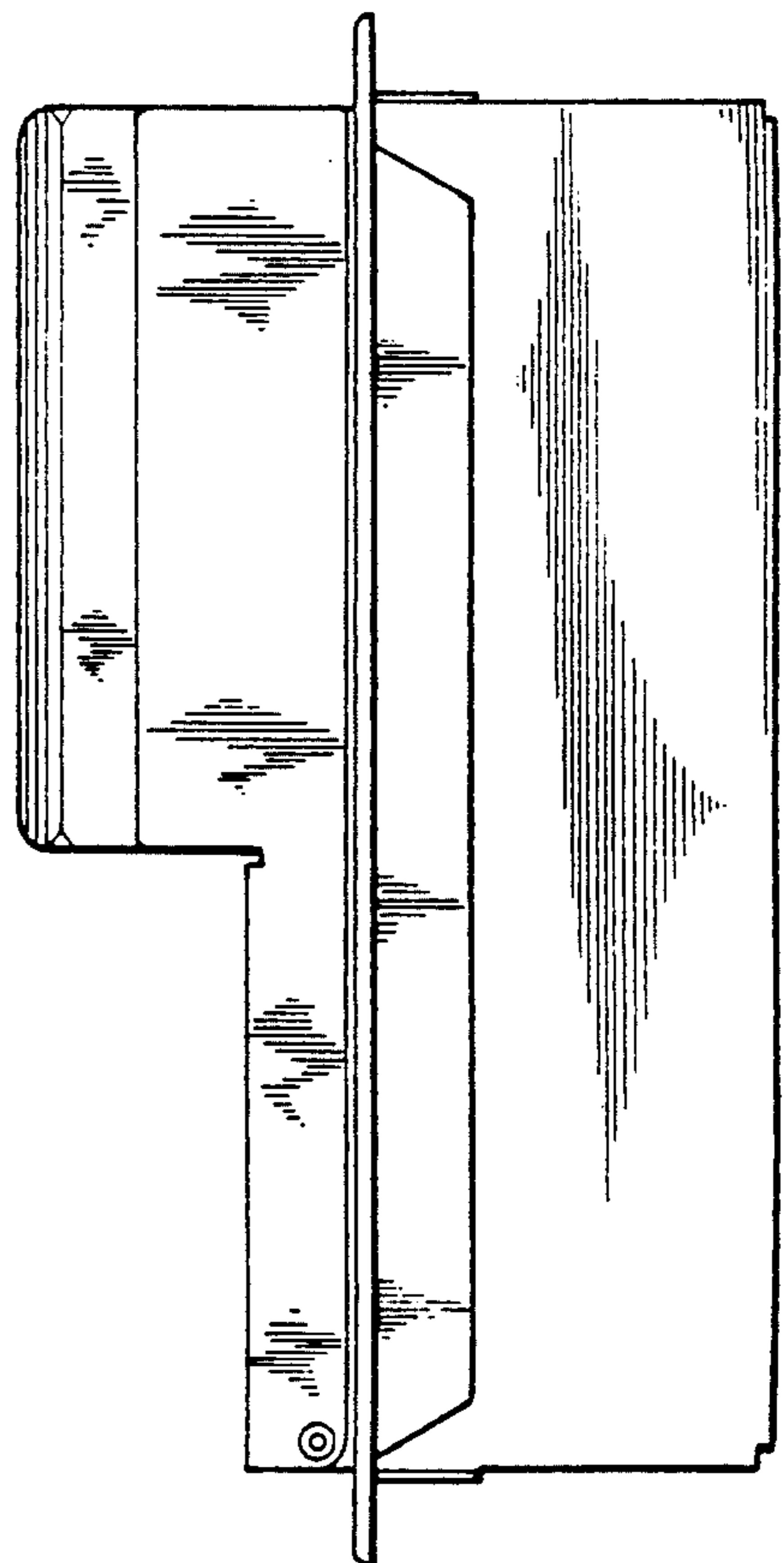

FIG. 9



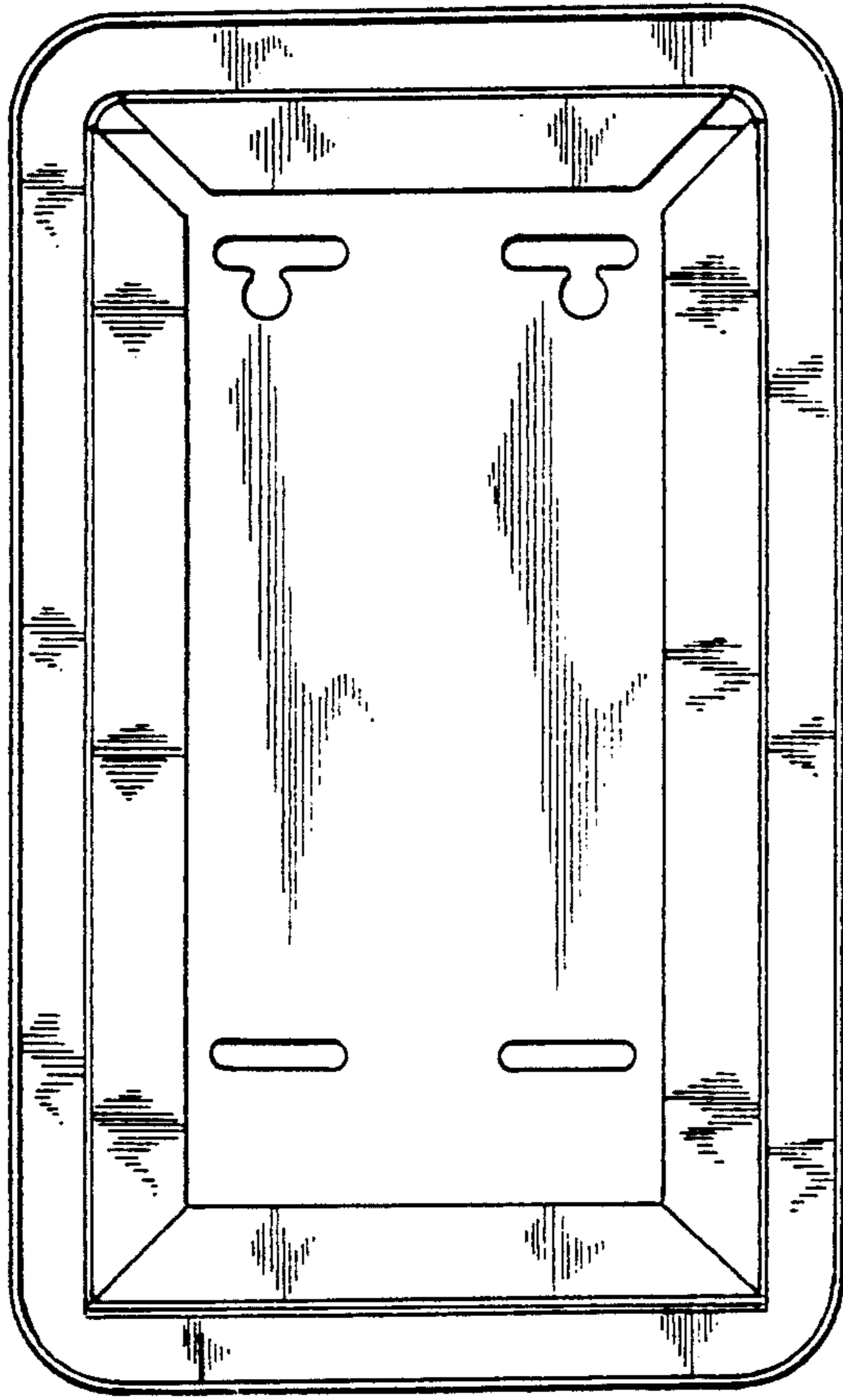

FIG. 11

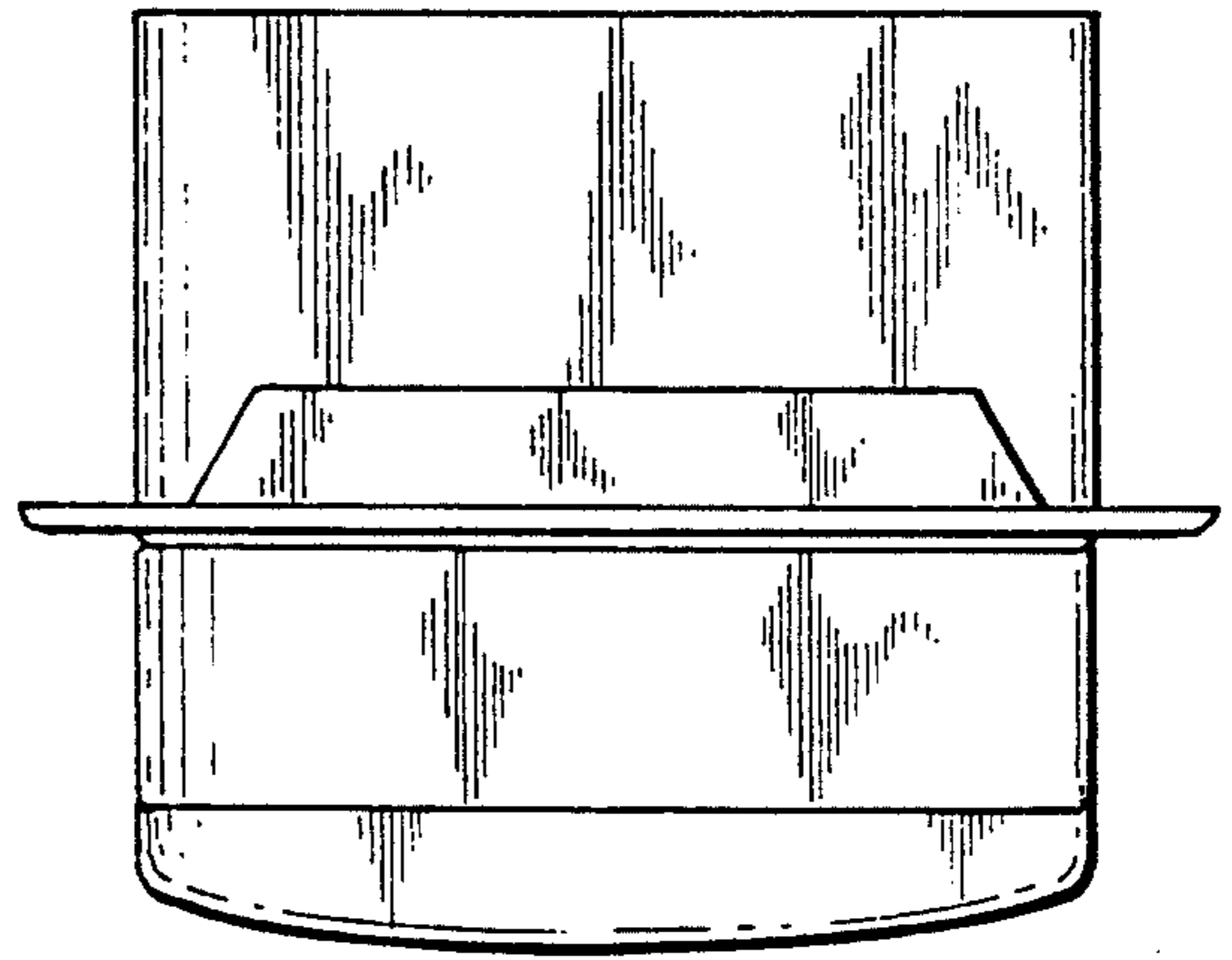

FIG. 10

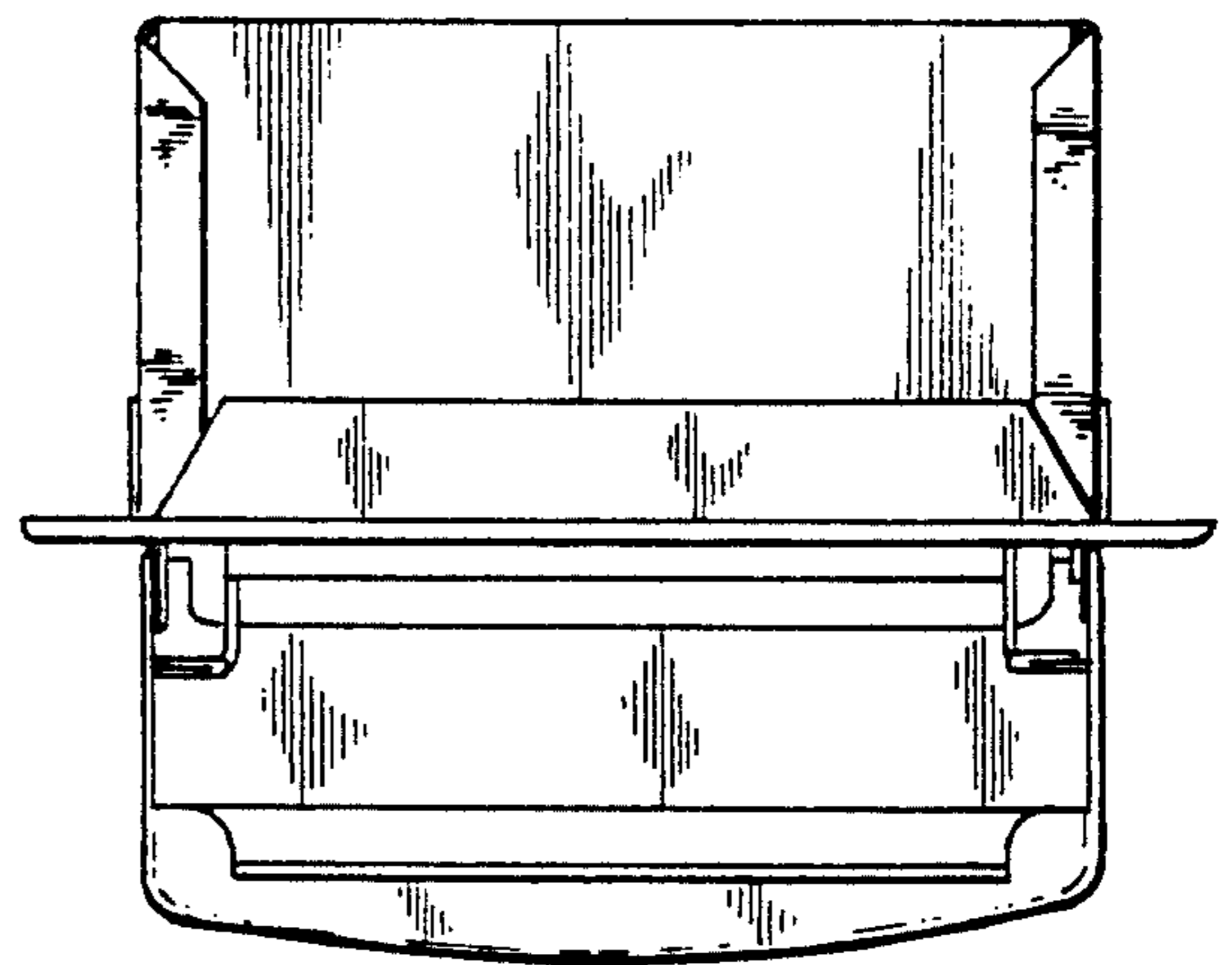

FIG. 12