



US00D340255S

United States Patent [19]

[11] Patent Number: **Des. 340,255**

Yip

[45] Date of Patent: **** Oct. 12, 1993**

[54] CALCULATOR

[76] Inventor: **Chi-Wing A. Yip**, 1702 Yue Shing Comm. Bldg., 15-16 Queen Victoria St., Central, Hong Kong

[**] Term: **14 Years**

[21] Appl. No.: **820,958**

[22] Filed: **Jan. 15, 1992**

[30] Foreign Application Priority Data

Jul. 15, 1991 [GB] United Kingdom 2016005
[52] U.S. Cl. **D18/6**
[58] Field of Search **D18/1-12**

[56] References Cited

U.S. PATENT DOCUMENTS

D. 297,547 9/1988 Sasaki D18/7

OTHER PUBLICATIONS

Hong Kong Enterprise, Jul. 1985, p. 184, Calculator #10-838, top right corner of pg.

Hong Kong Enterprise Mar. 1989, p. 131, Calculator #822, top right of pg.

Primary Examiner—Alan P. Douglas
Assistant Examiner—Ann Hunt
Attorney, Agent, or Firm—Sandler Greenblum & Bernstein

[57] CLAIM

The ornamental design for a calculator, as shown and described.

DESCRIPTION

FIG. 1 is a front elevational view of a calculator in an open position, showing my new design; FIG. 2 is a rear elevational view thereof; FIG. 3 is a side elevational view thereof; FIG. 4 is a side elevational view of the other side thereof; FIG. 5 is a top plan view thereof; FIG. 6 is a bottom plan view thereof; and, FIG. 7 is a perspective view from above and one side of the calculator in the closed position.

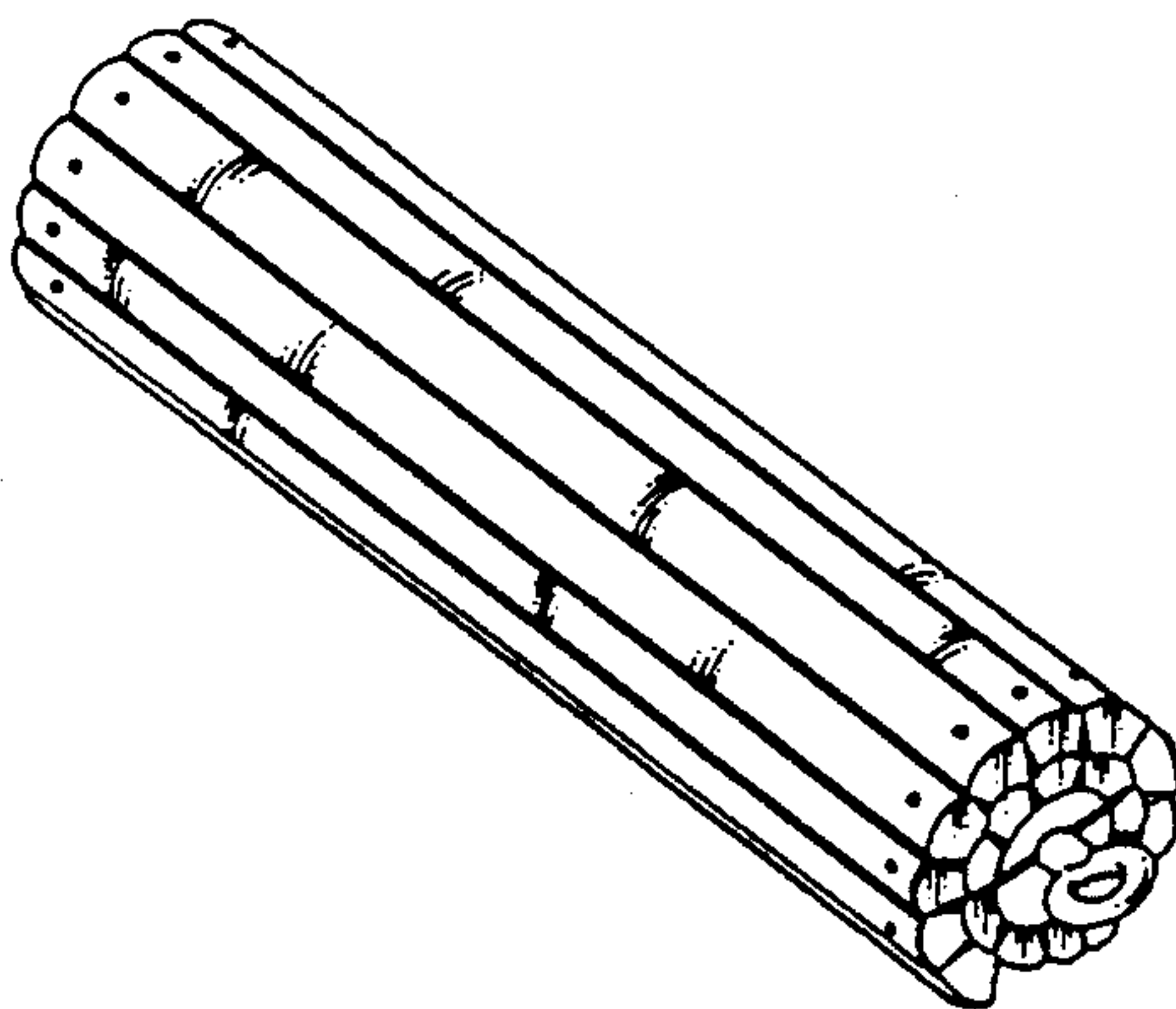
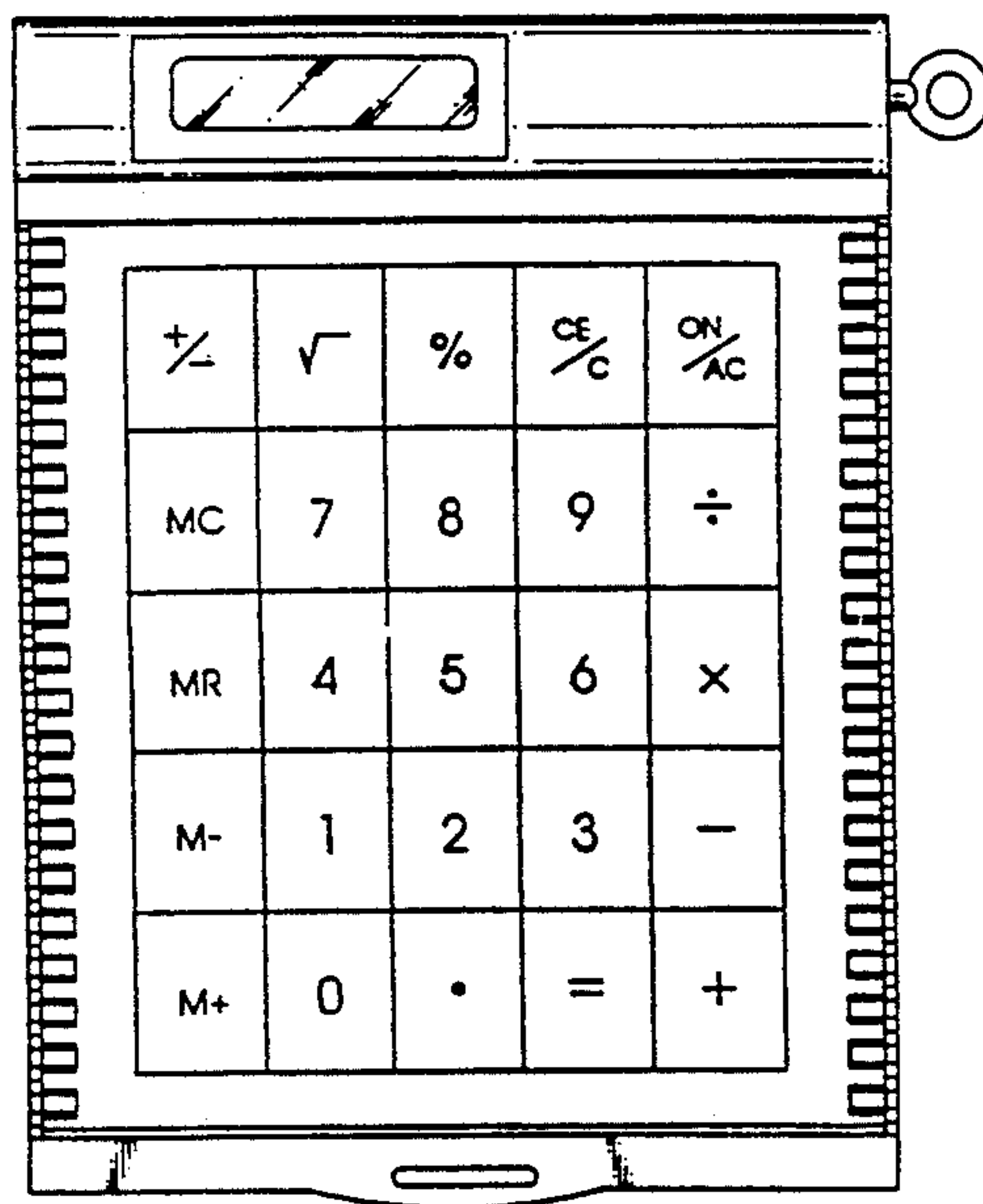

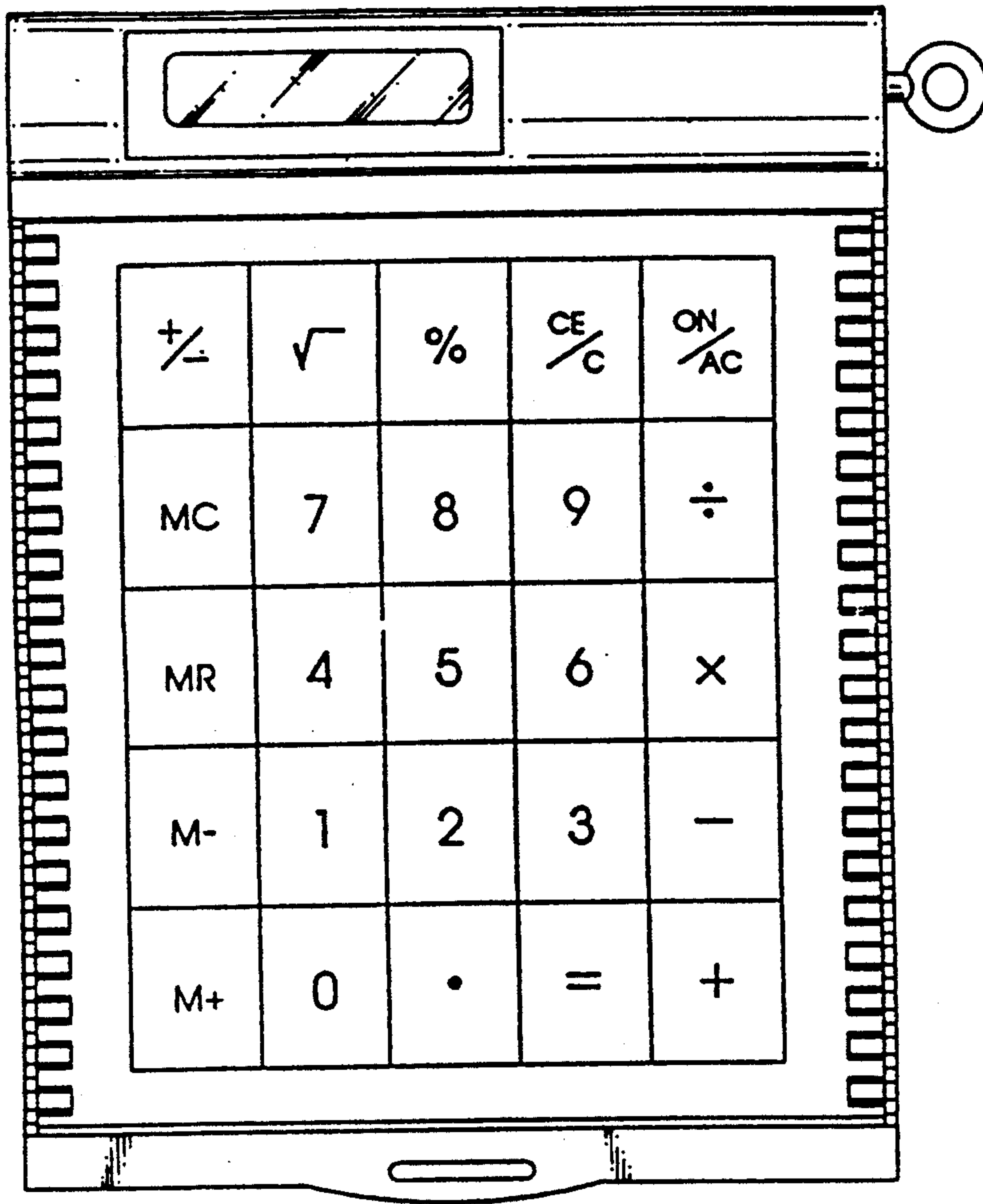

FIG. 1

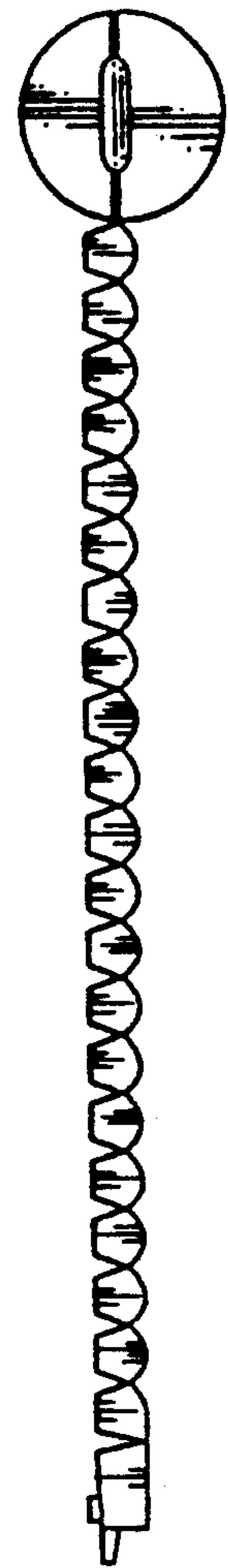

FIG. 3

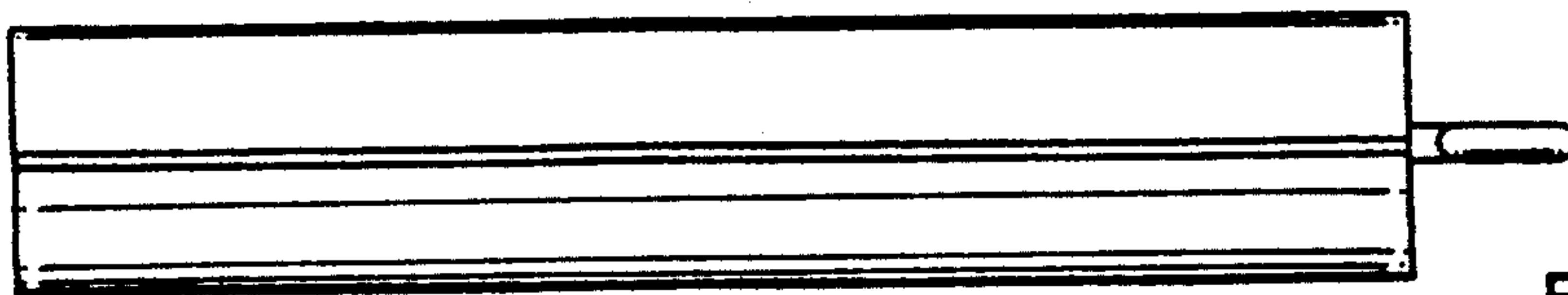

FIG. 5

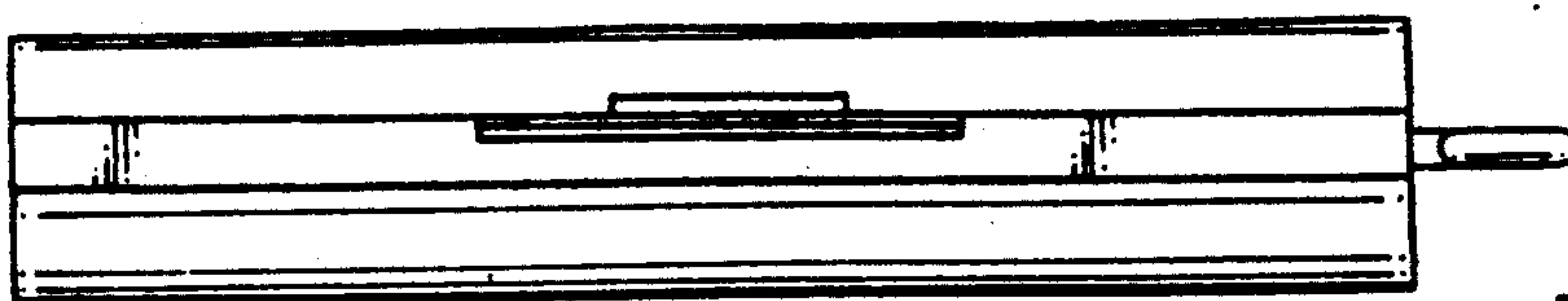

FIG. 6

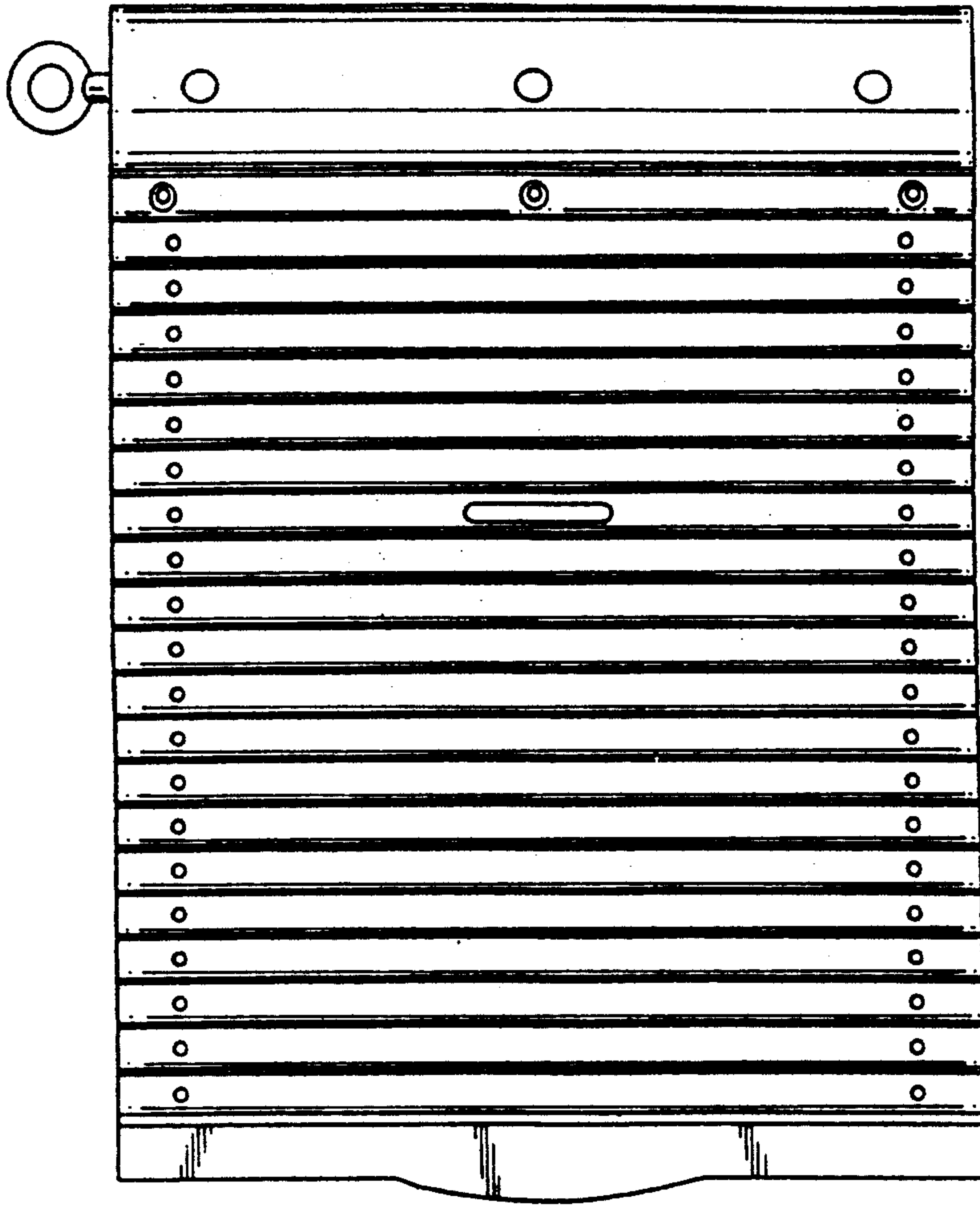

FIG. 2

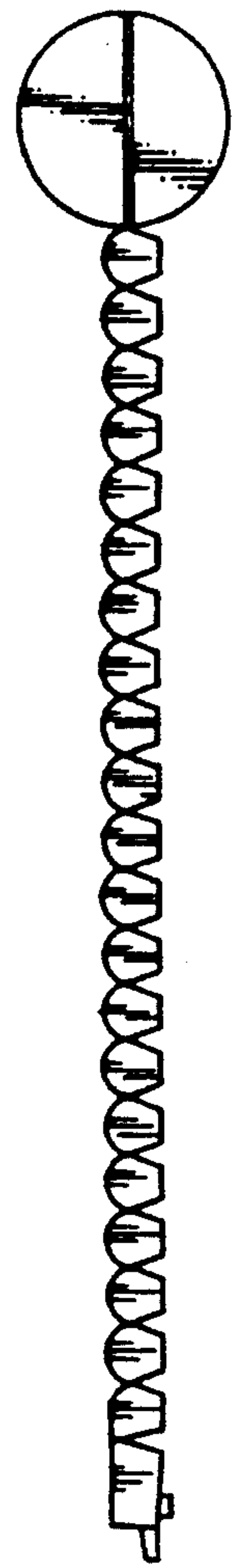

FIG. 4

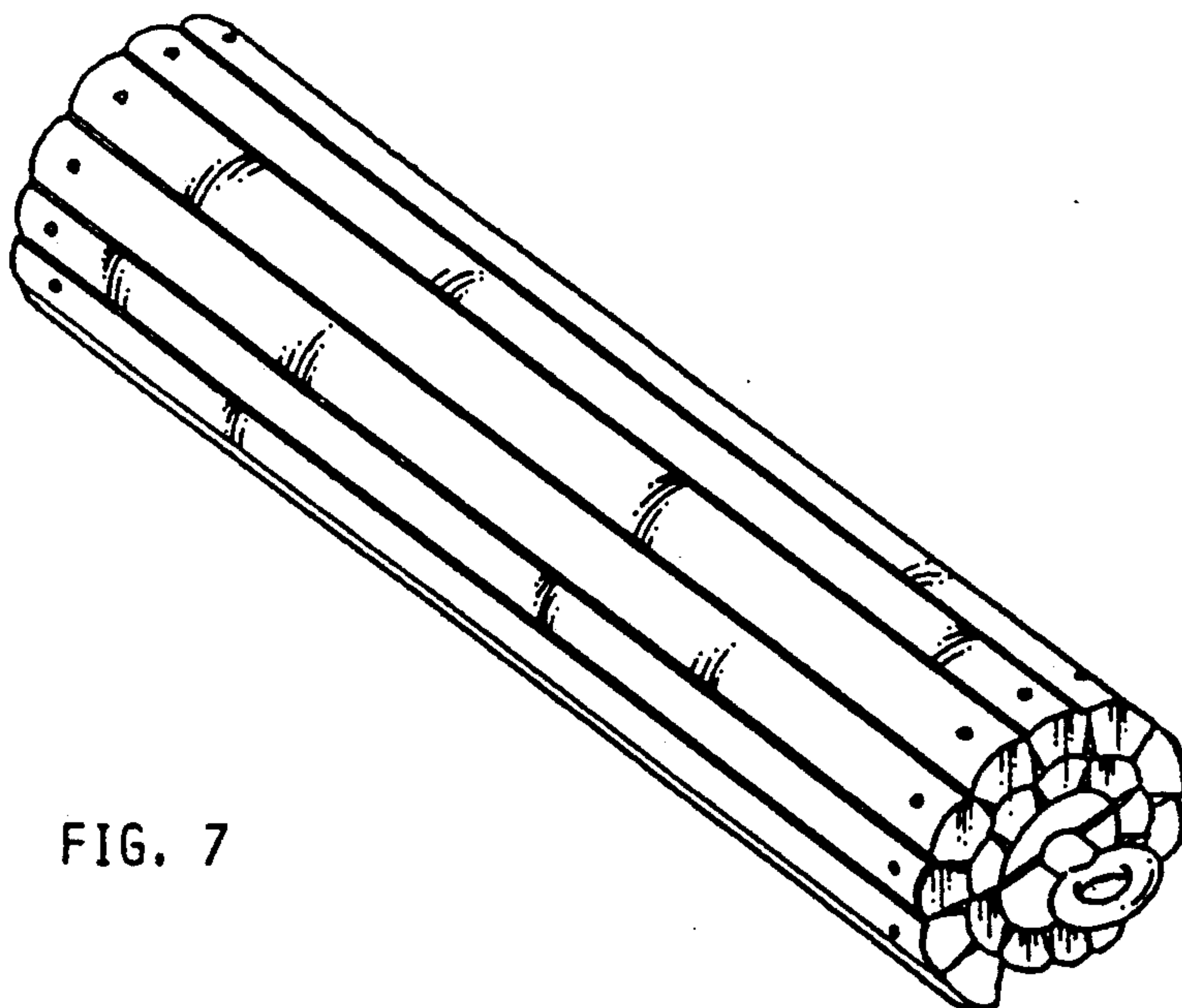

FIG. 7