



US00D340226S

# United States Patent [19]

[11] Patent Number: **Des. 340,226**

Sachs

[45] Date of Patent: **\*\* Oct. 12, 1993**

[54] ELECTRICAL GROUND CLIP

Attorney, Agent, or Firm—Longacre & White

[76] Inventor: **Isaac Sachs**, 283 Newton,  
Dollard-des-Ormeaux, Quebec,  
Canada, H9A 3G1

[57] CLAIM

The ornamental design for an electrical ground clip, as shown and described.

[\*\*] Term: **14 Years**

### DESCRIPTION

[21] Appl. No.: **837,427**

[22] Filed: **Feb. 20, 1992**

[52] U.S. Cl. .... **D13/154; D8/356**

[58] Field of Search ..... **D13/133, 154; D8/356;**  
**174/6, 35 GC, 40 CC, 51; 439/92, 95, 108, 110**

### [56] References Cited

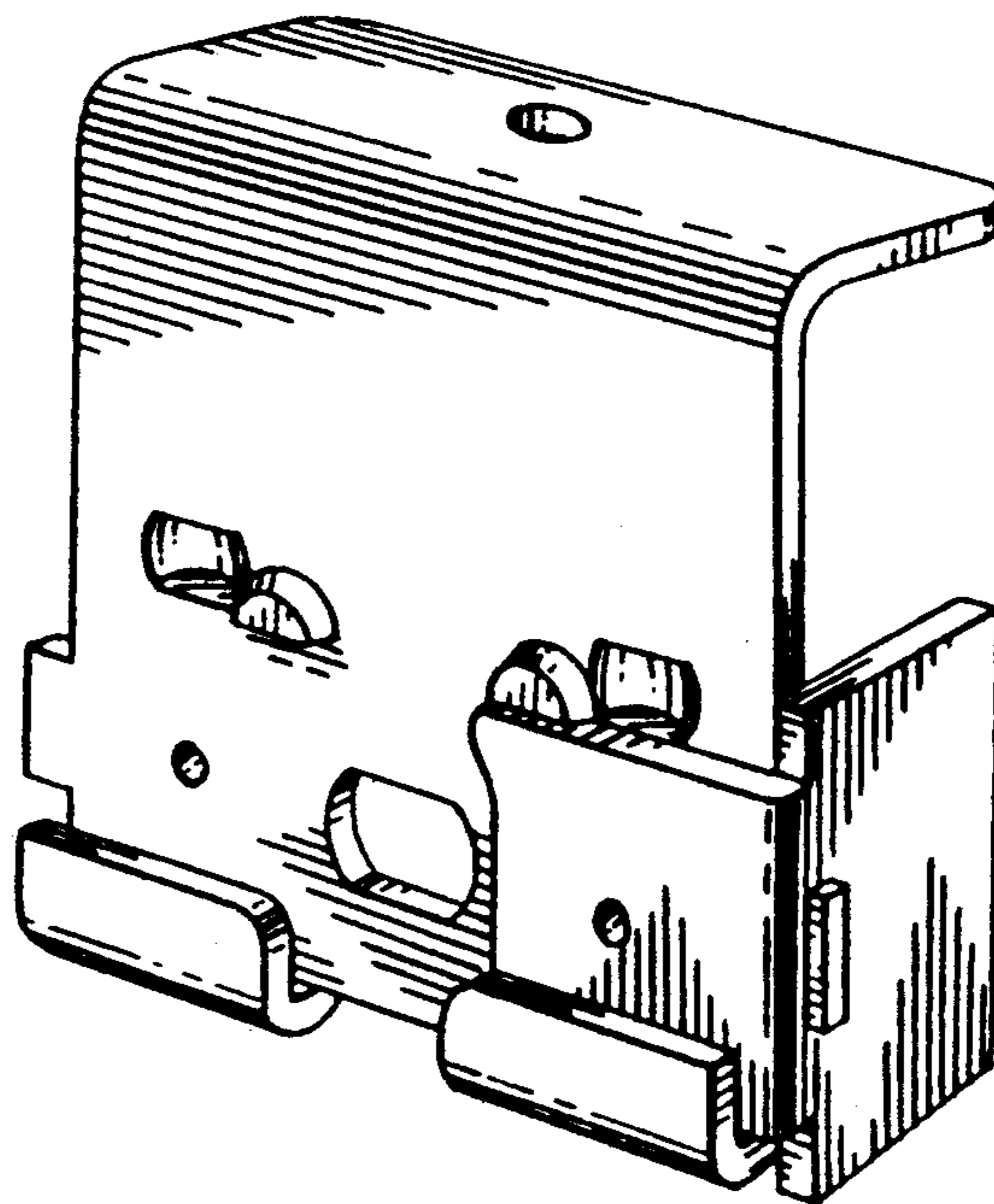
#### U.S. PATENT DOCUMENTS

D. 297,410	8/1988	Sachs	.....	D8/356
2,911,608	11/1959	Lee	.....	174/35 GC X
3,029,405	4/1962	Buchanan	.....	439/95
3,919,457	11/1975	Steiner	.....	439/110 X
4,186,981	2/1980	Holton	.....	439/92

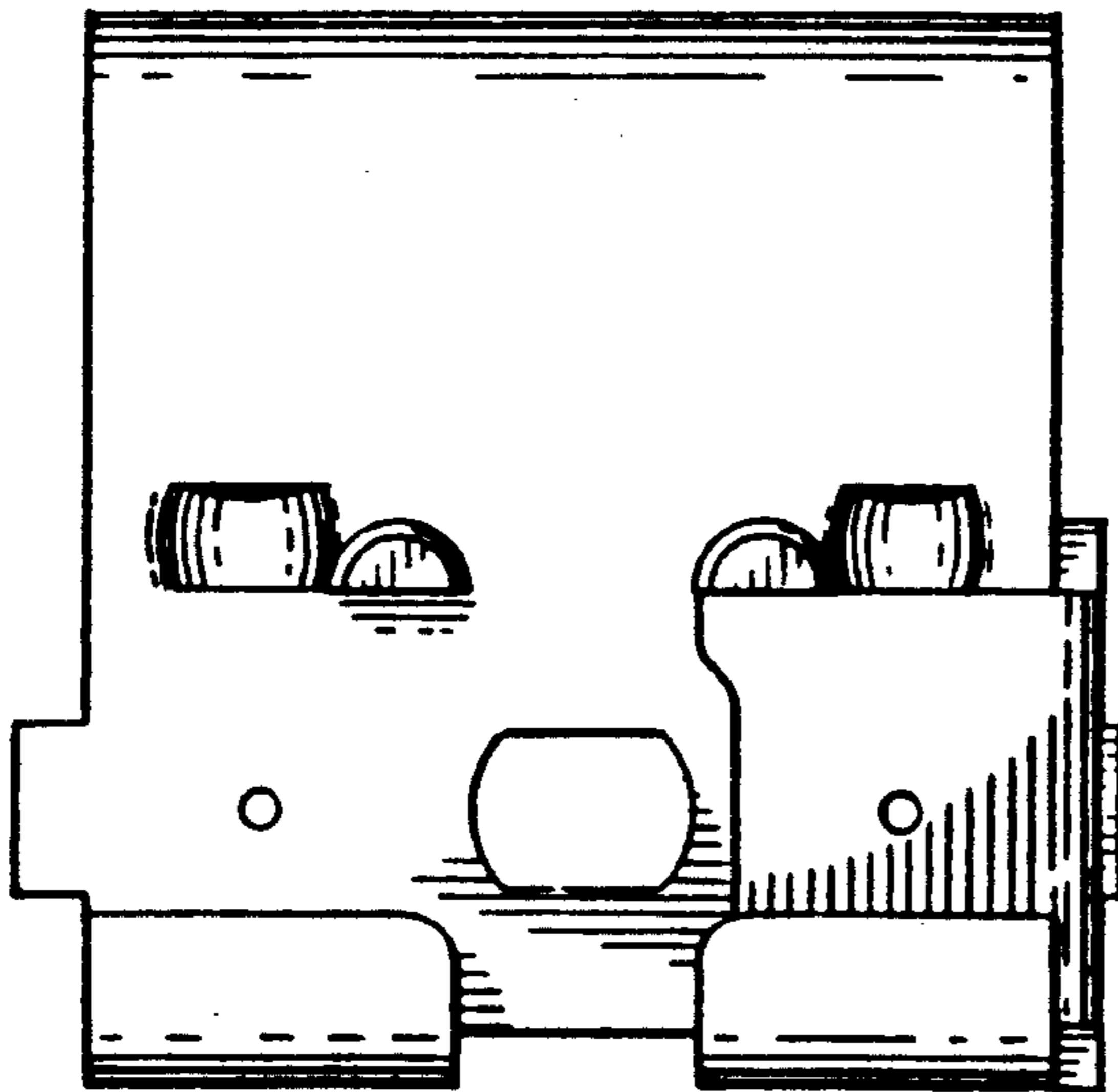
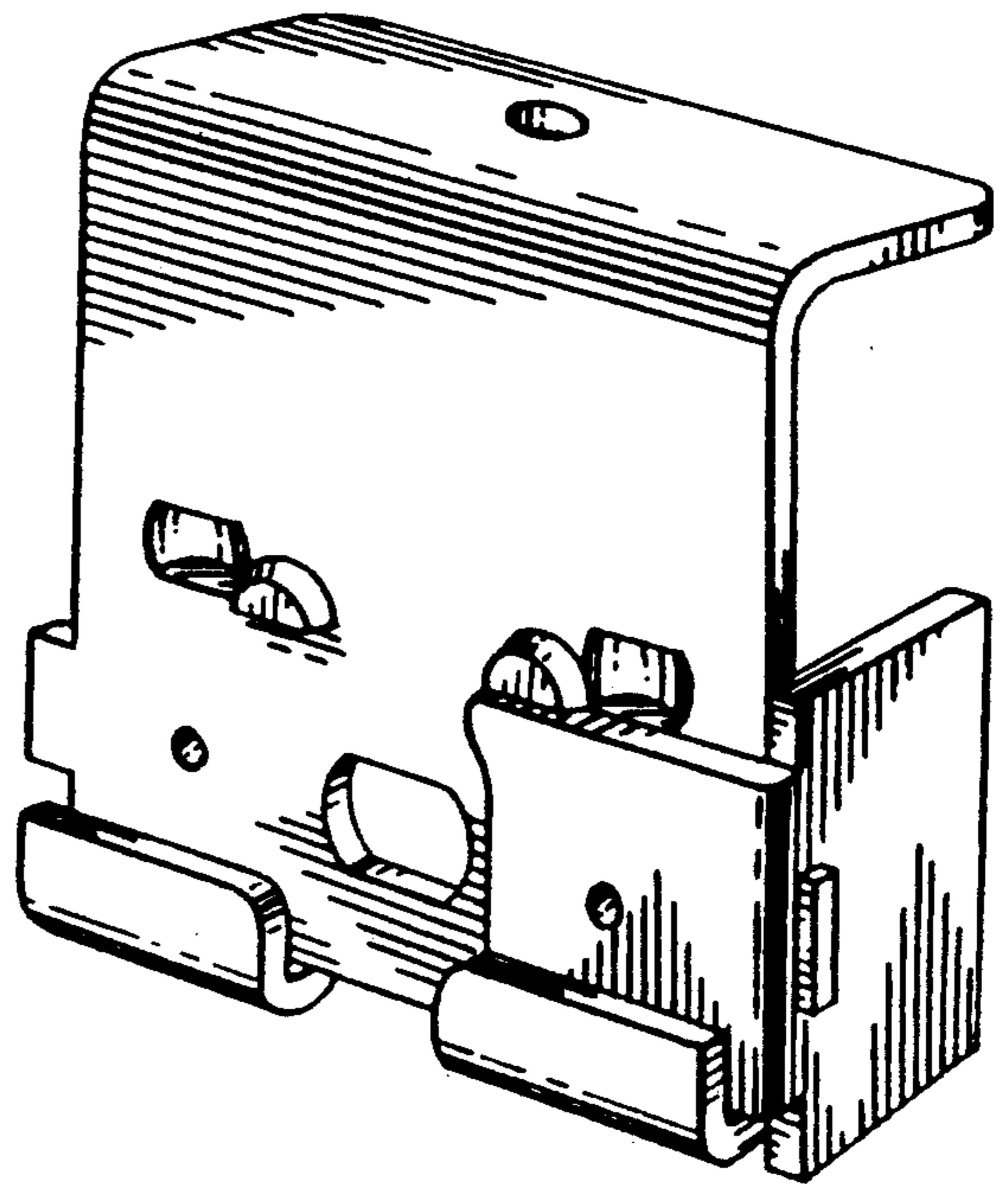
FIG. 1 is a right side, top and front perspective view of an electrical ground clip showing my new design;  
 FIG. 2 is a front elevational view thereof;  
 FIG. 3 is a left side elevational view thereof;  
 FIG. 4 is a right side elevational view thereof;  
 FIG. 5 is a rear elevational view thereof;  
 FIG. 6 is a top plan view thereof;  
 FIG. 7 is a bottom plan view thereof;  
 FIG. 8 is a left side, top and front perspective view of an electrical ground clip showing a second embodiment of my new design;  
 FIG. 9 is a front elevational view thereof;  
 FIG. 10 is a left side elevational view thereof;  
 FIG. 11 is a right side elevational view thereof;  
 FIG. 12 is a rear elevational view thereof;  
 FIG. 13 is a top plan view thereof; and,  
 FIG. 14 is a bottom plan view thereof.

Primary Examiner—Wallace R. Burke

Assistant Examiner—J. Sincavage

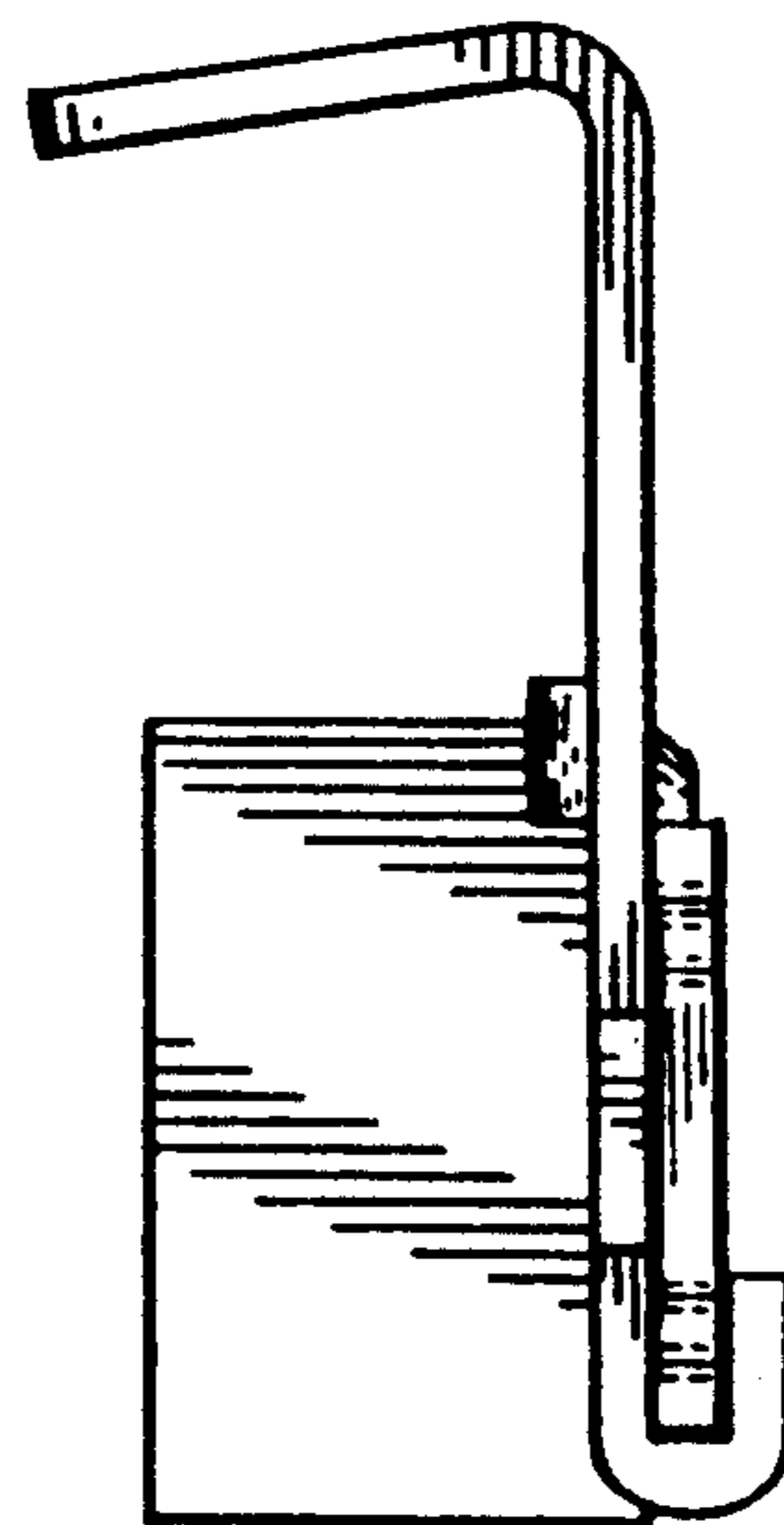


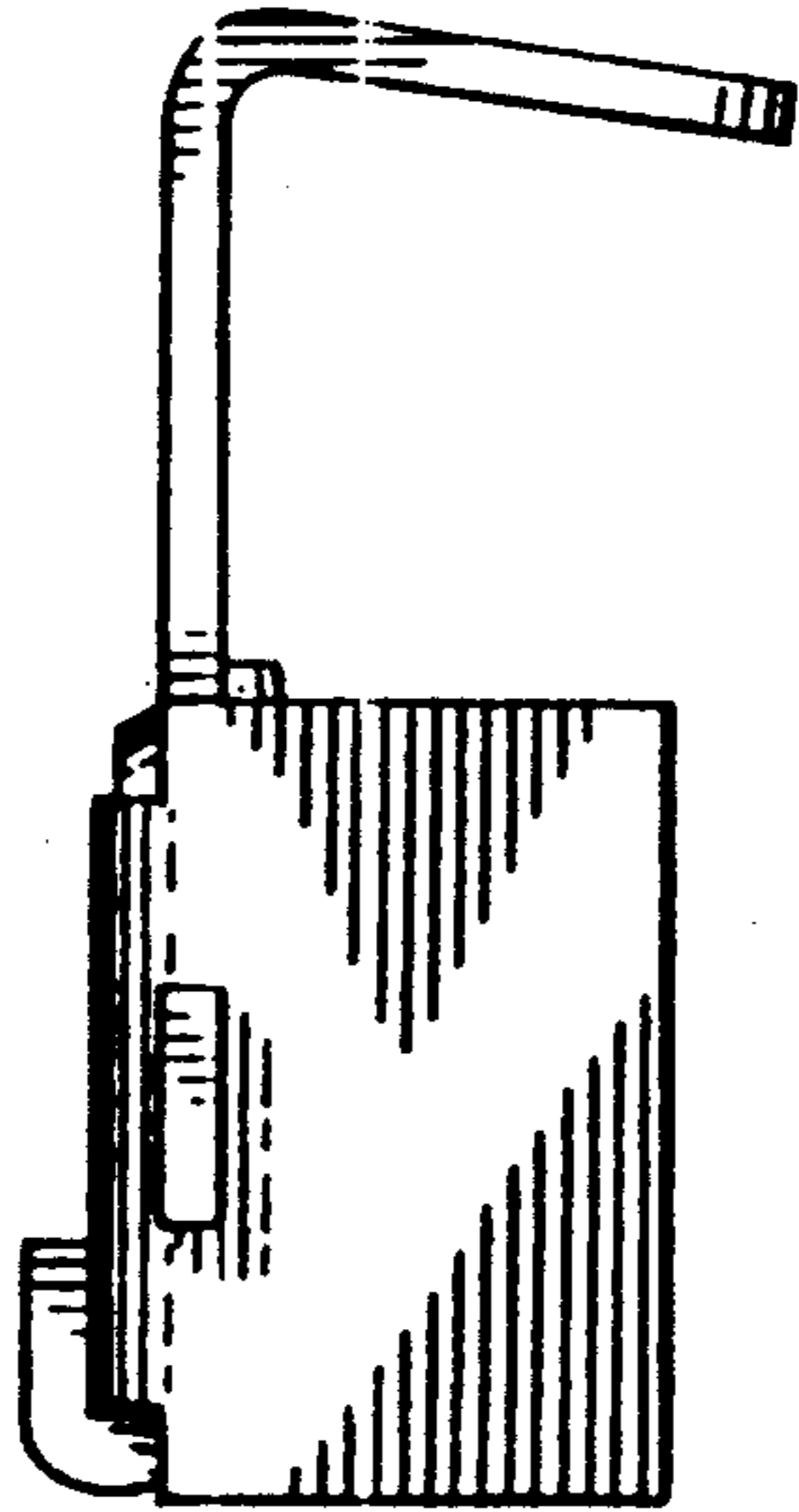
*Fig. 1*



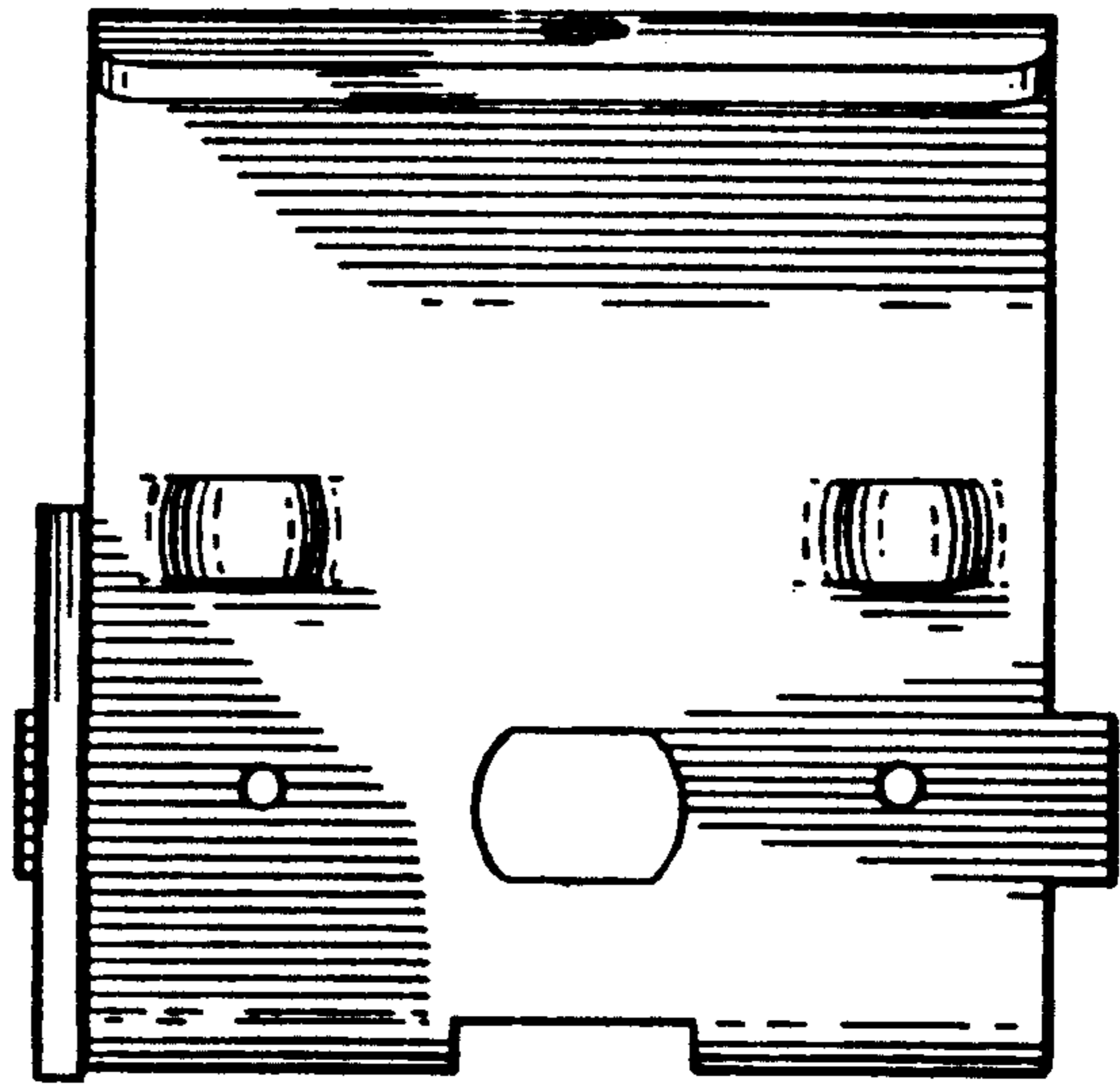
*Fig. 2*

*Fig. 3*

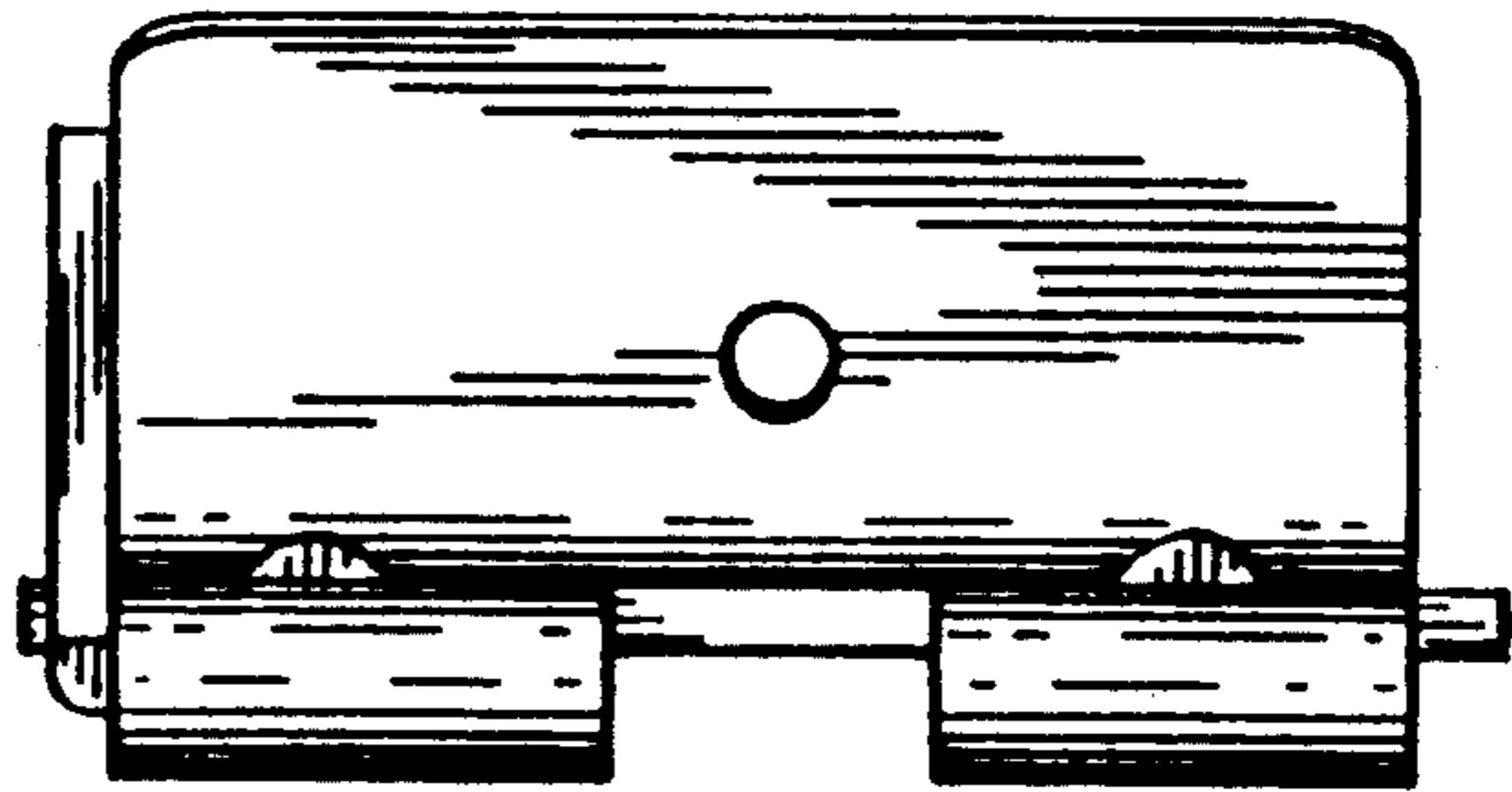




*Fig. 4*

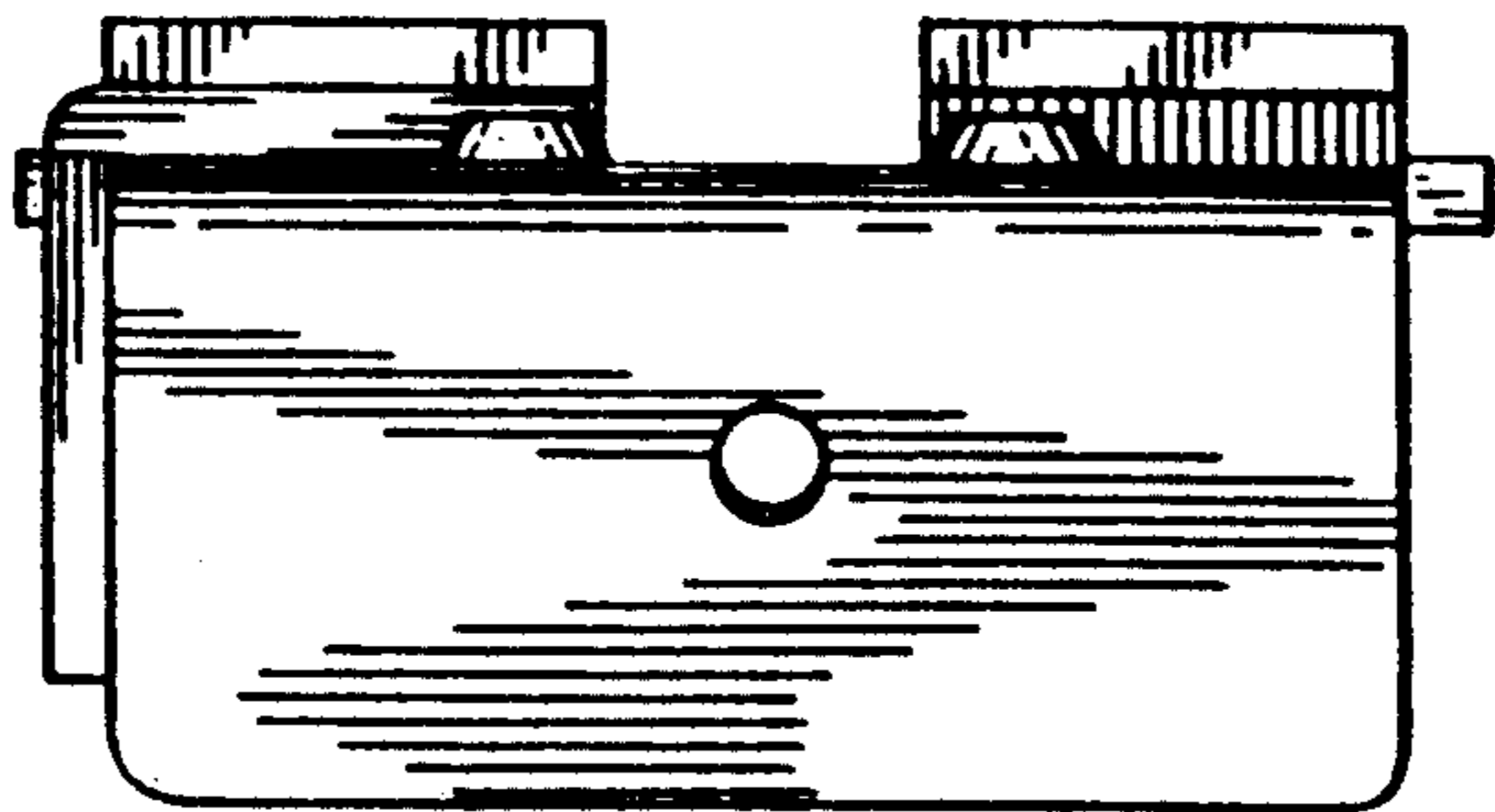


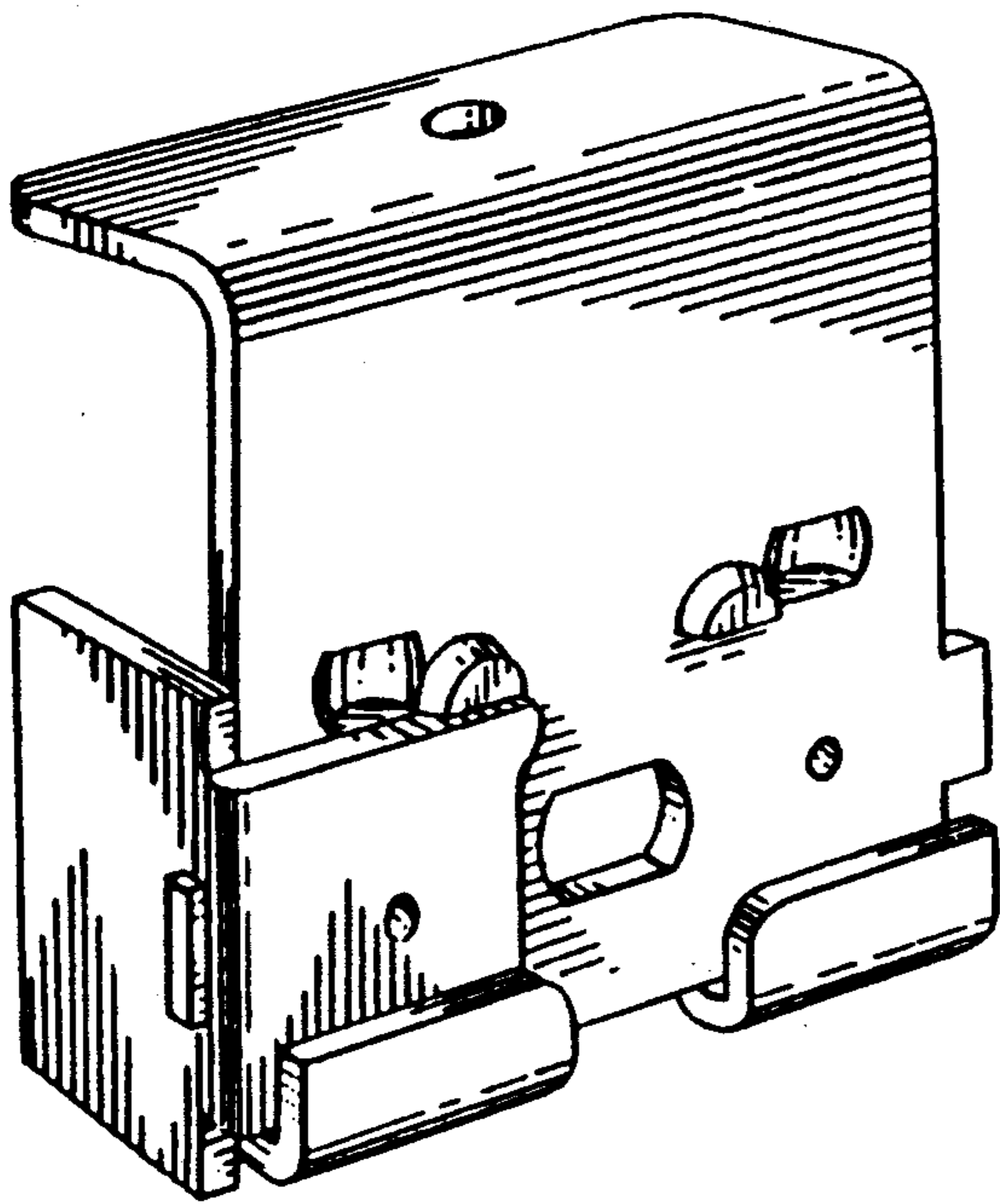
*Fig. 5*



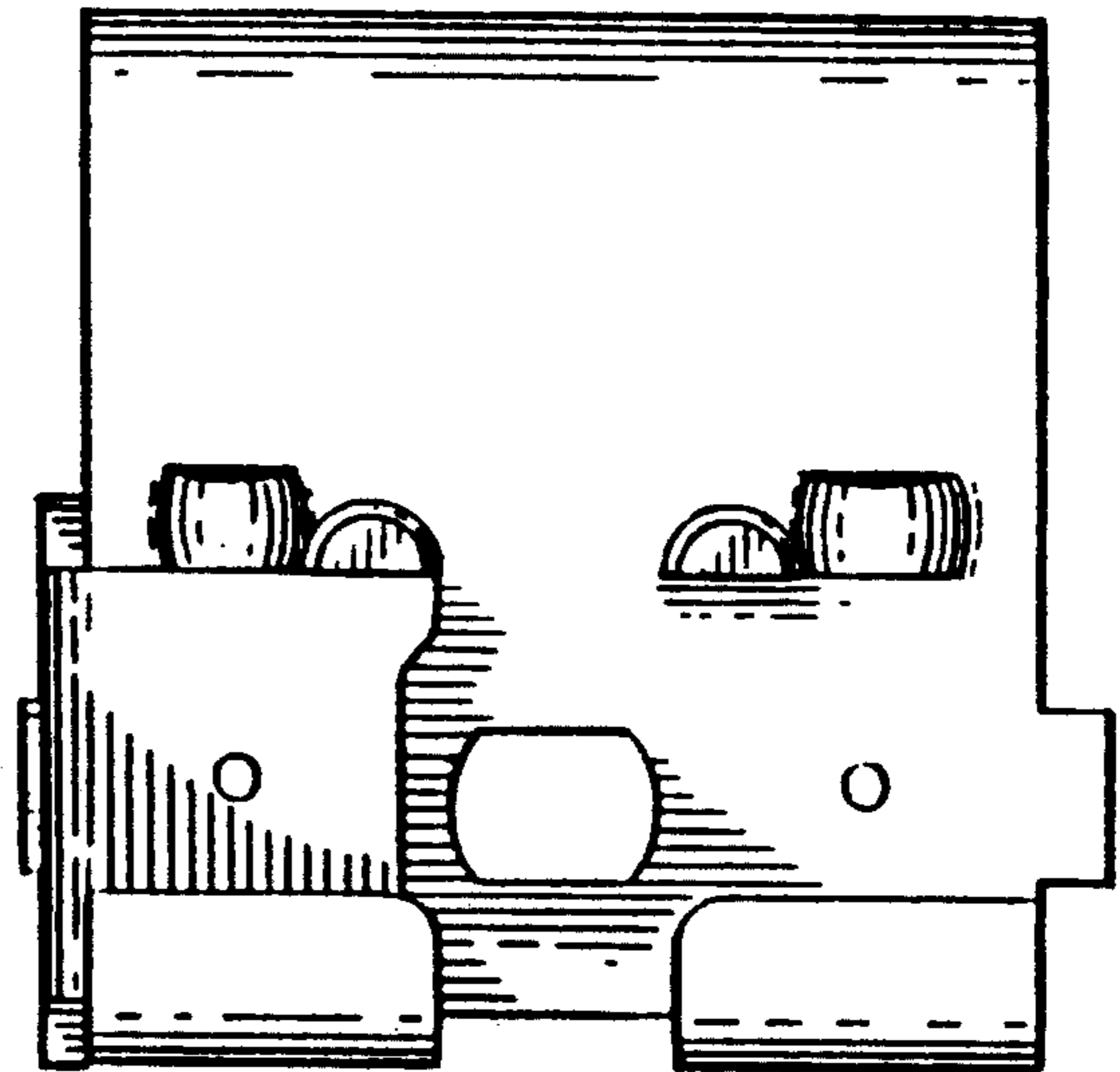
*Fig. 7*

*Fig. 6*

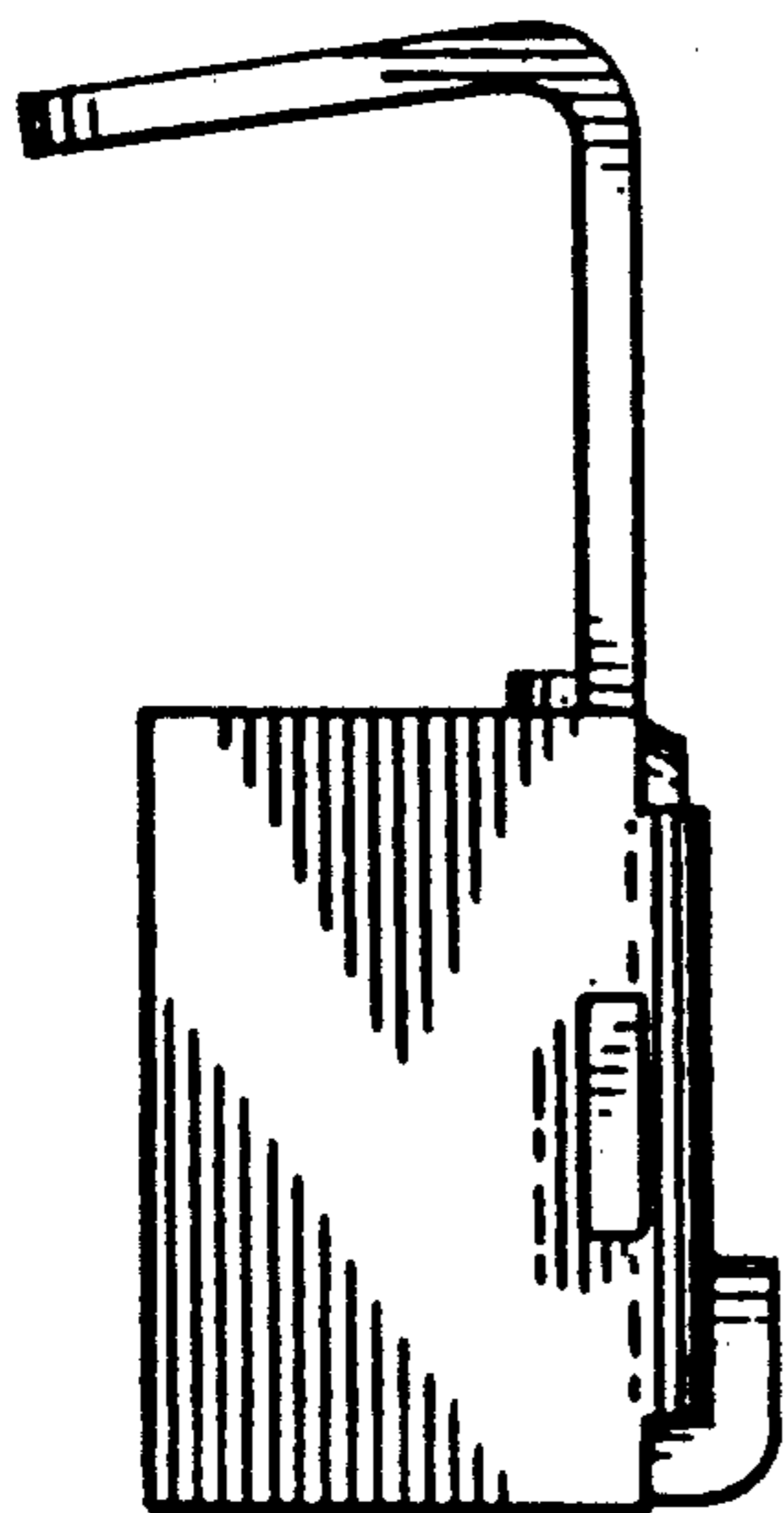




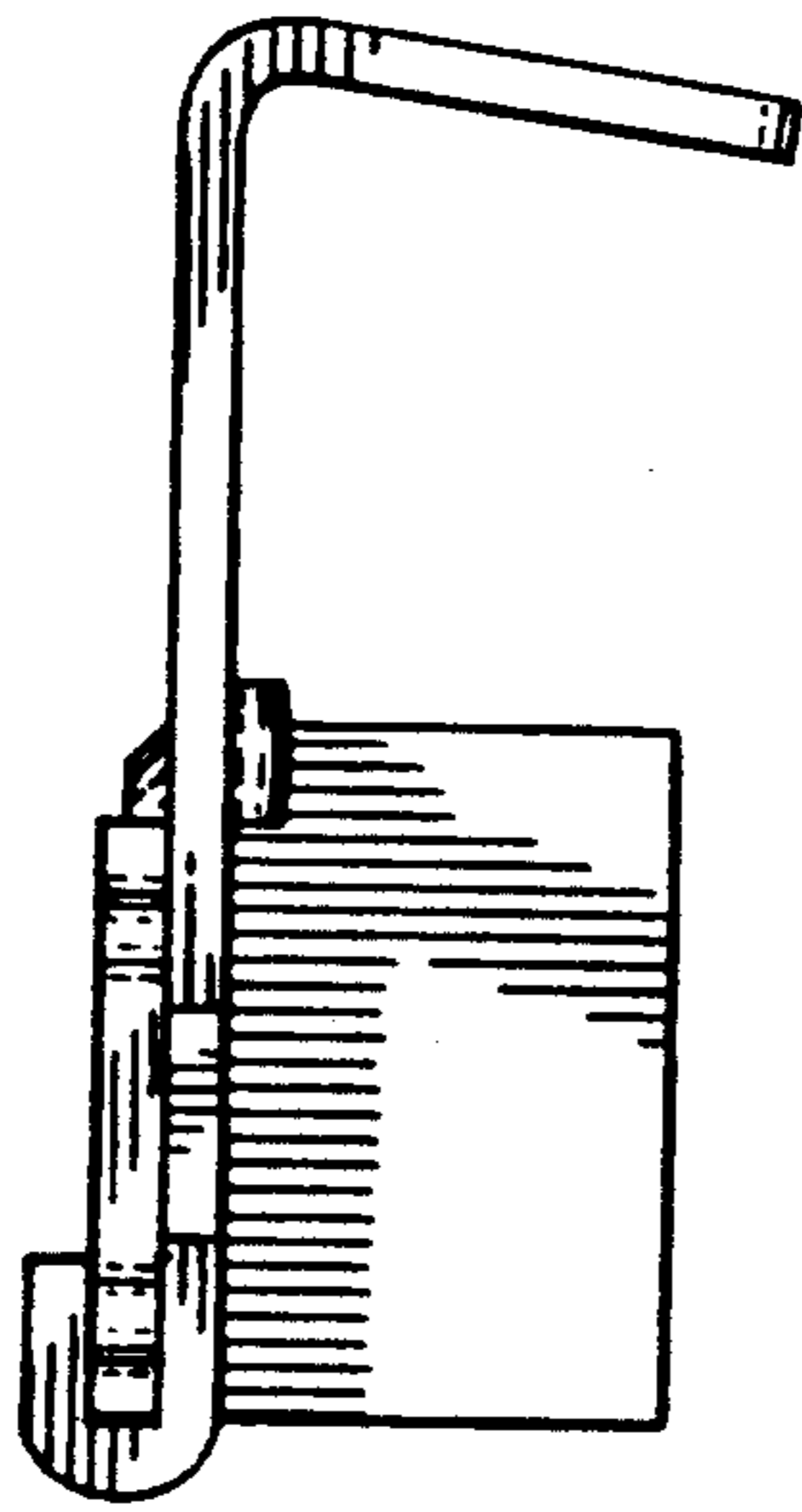
*Fig. 8*



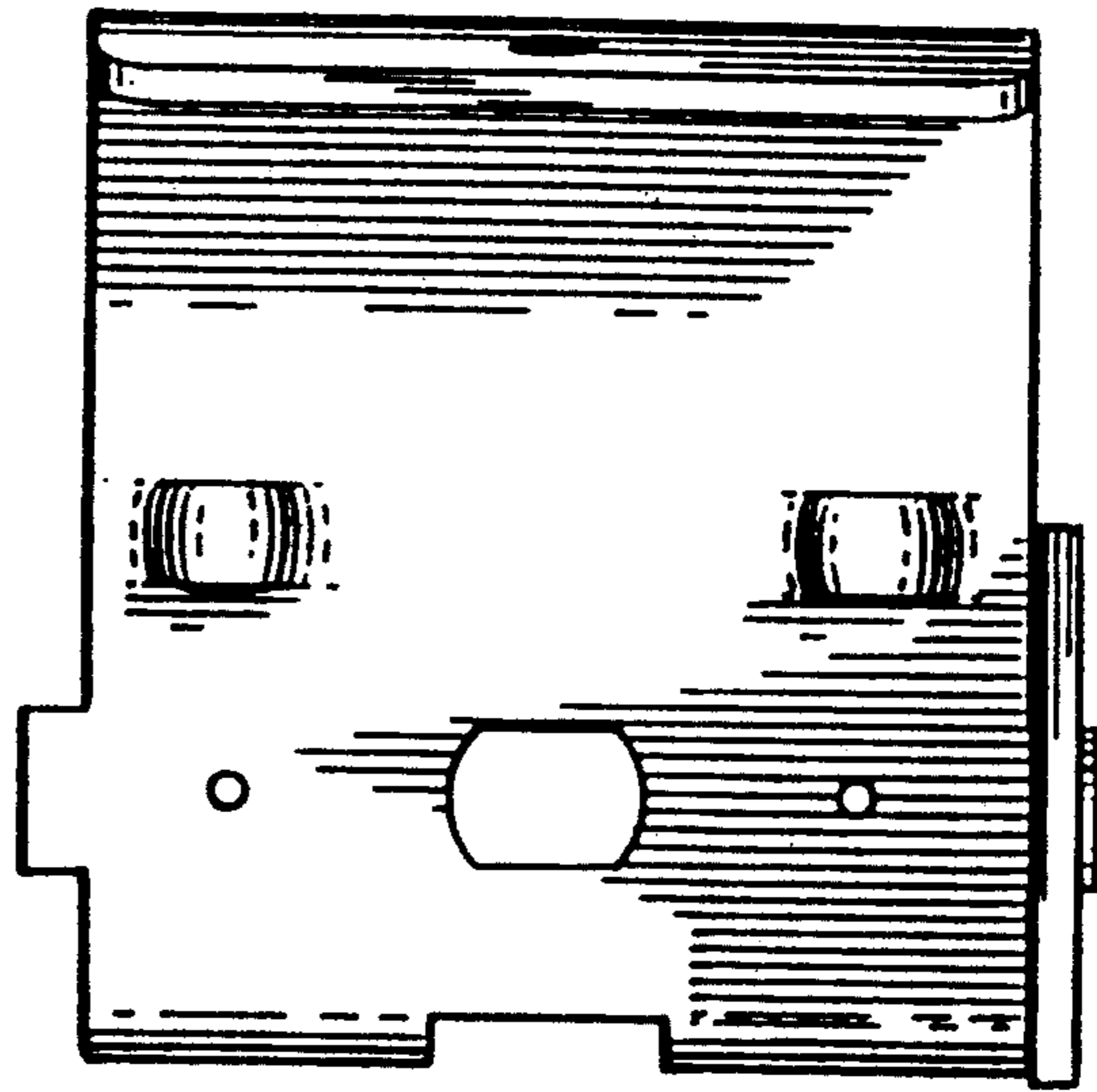
*Fig. 9*



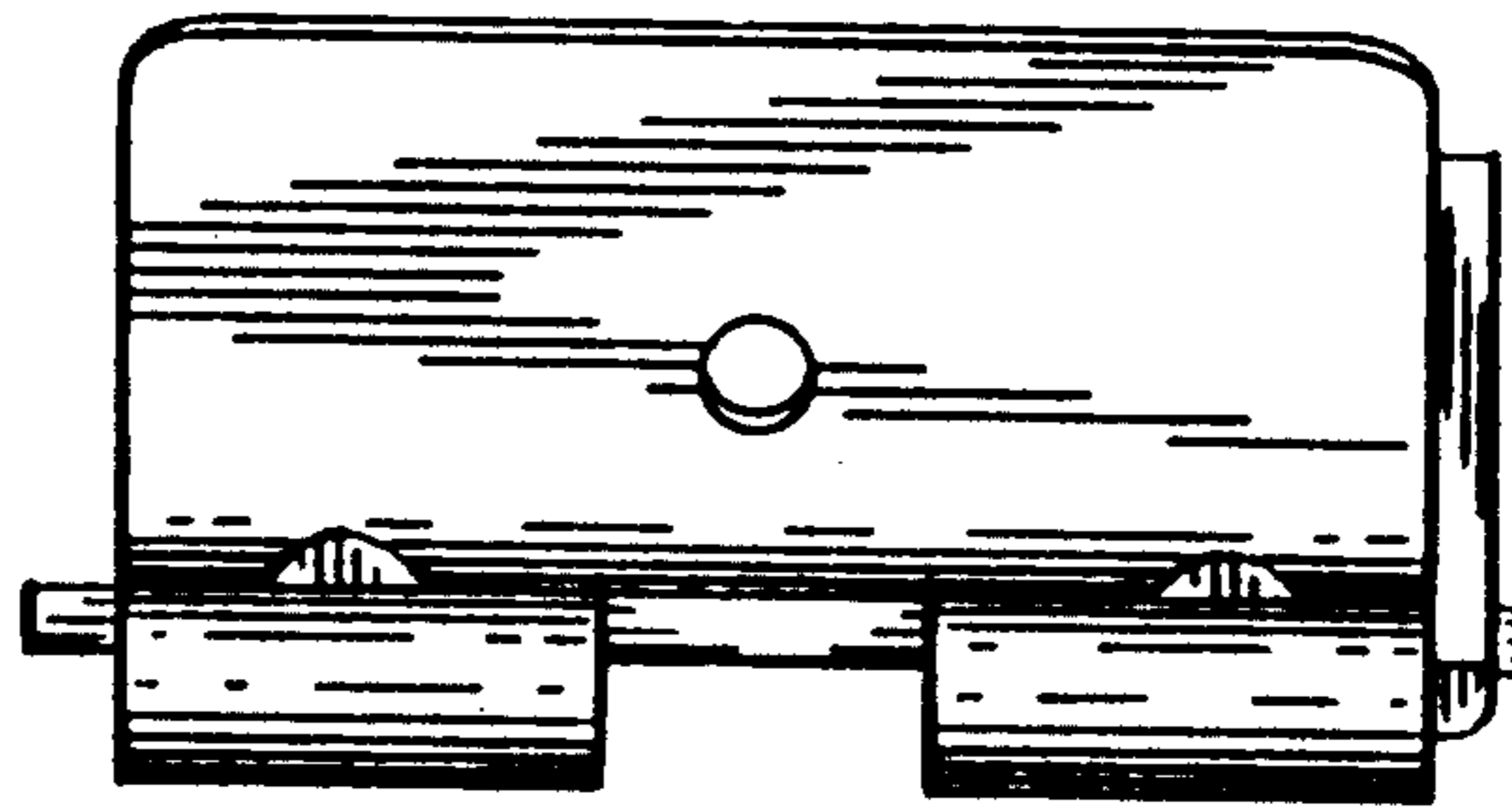
*Fig. 10*



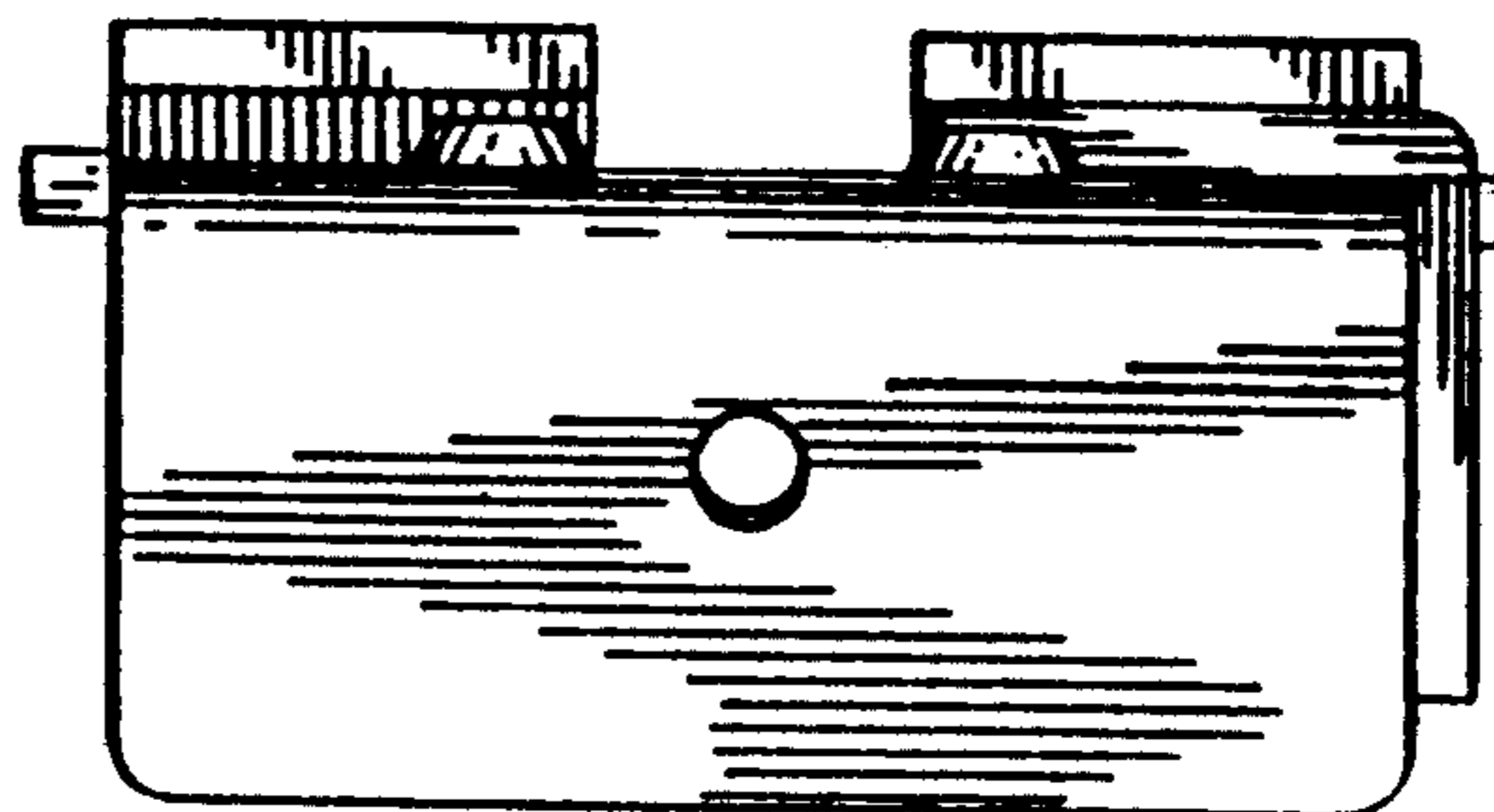
*Fig. 11*



*Fig. 12*



*Fig. 14*



*Fig. 13*