



US00D340177S

United States Patent [19]

[11] Patent Number: **Des. 340,177**

Key

[45] Date of Patent: **** Oct. 12, 1993**

[54] **MULTIPURPOSE COMBINATION WELDER AND MILLWRIGHT HAMMER**

4,352,381 10/1982 Provi 81/20
4,357,974 11/1982 Nannen 81/20
4,433,709 2/1984 Porter 81/26

[76] Inventor: **Cecil Key**, P.O. Box 141, Sparkman, Ark. 71763

Primary Examiner—Bernard Ansher
Assistant Examiner—P. Hyder
Attorney, Agent, or Firm—Stephen D. Carver; Jerry L. Mahurin

[**] Term: **14 Years**

[21] Appl. No.: **761,028**

[22] Filed: **Sep. 17, 1991**

[52] U.S. Cl. **D8/75; D8/76**

[58] Field of Search **D8/75, 76, 78; 81/20, 81/21, 22, 23, 24, 25, 26, 27; 7/143, 146, 147; 30/308.2**

[57] CLAIM

The ornamental design for a multipurpose combination welder and millwright hammer, as shown and described.

DESCRIPTION

FIG. 1 is a perspective view of my multipurpose combination welder and millwright hammer;
FIG. 2 is a fragmentary left side elevational view thereof;
FIG. 3 is a fragmentary right side elevational view thereof;
FIG. 4 is a fragmentary front elevational view thereof;
FIG. 5 is a fragmentary rear elevational view thereof;
FIG. 6 is a top plan view thereof; and,
FIG. 7 is a bottom plan view thereof.

[56] References Cited

U.S. PATENT DOCUMENTS

D. 33,247	9/1900	Cederquist	D8/81
D. 257,826	1/1981	Jones	D8/76
D. 283,976	5/1986	Graves	D8/105
300,001	2/1989	Oberg	D8/78
300,111	3/1989	Square	D8/75
301,679	6/1989	Kokkinos	D8/75
1,643,861	9/1927	Szakacs	145/2
4,208,148	6/1980	Bisantz	81/20

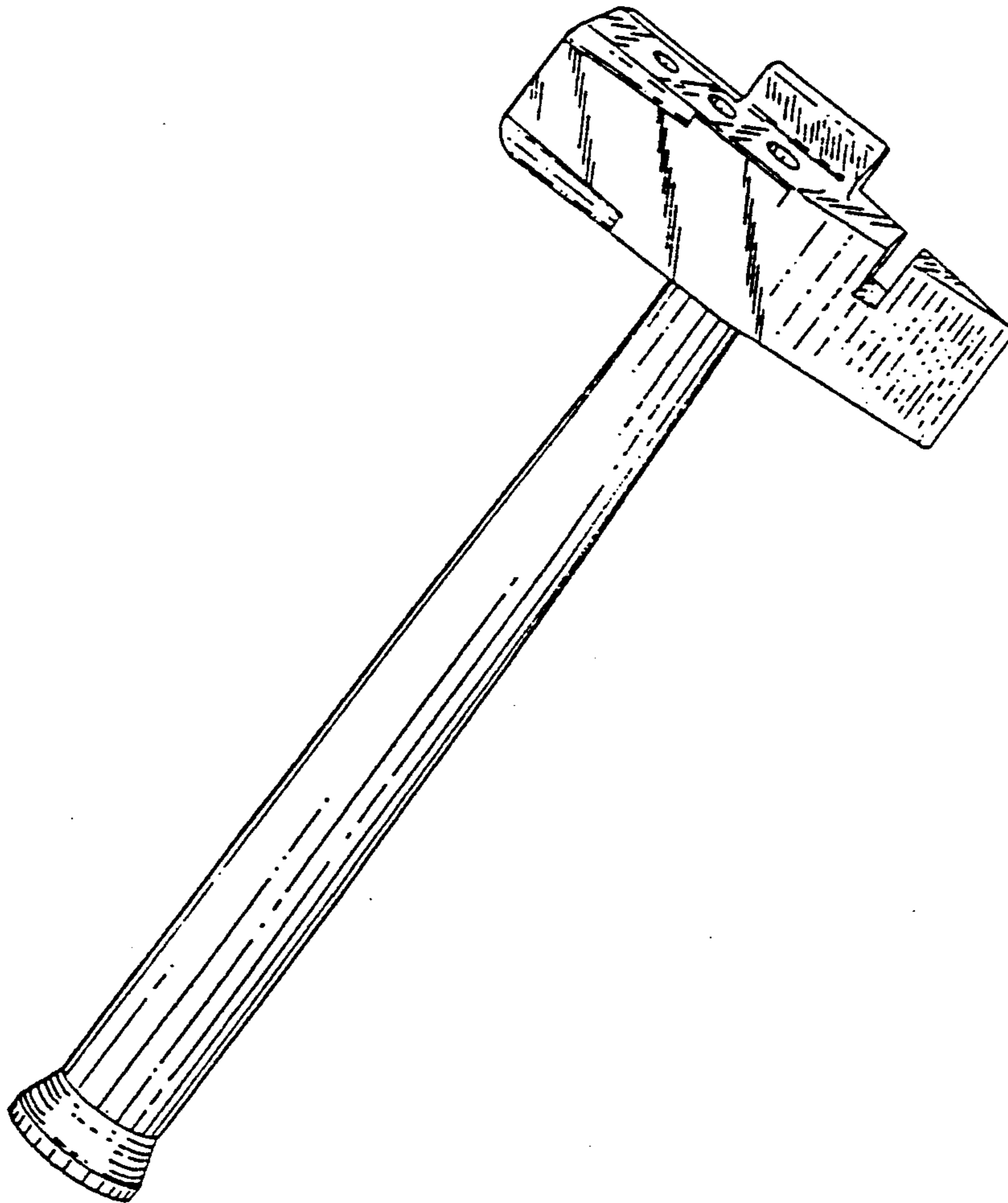

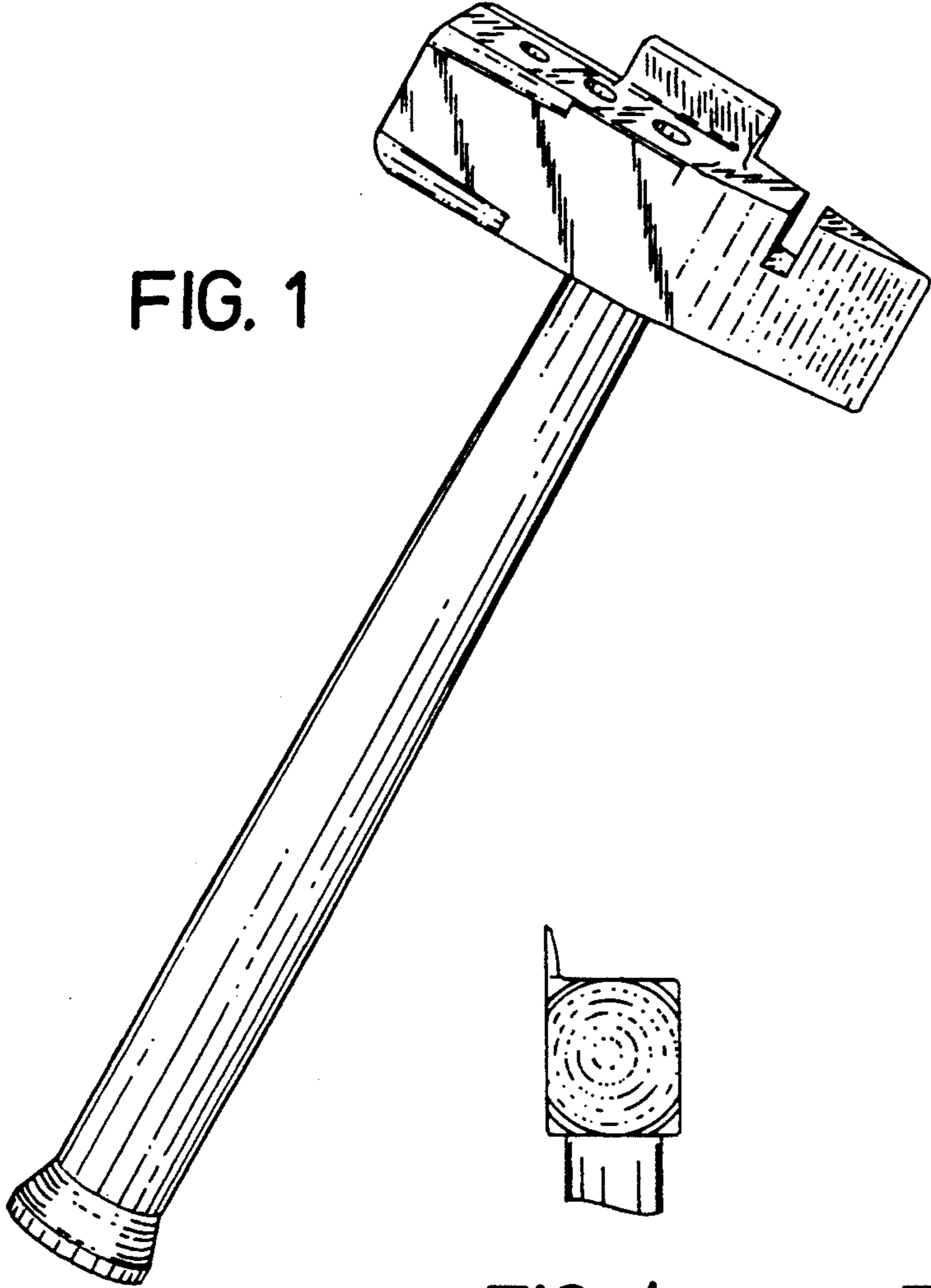

FIG. 1

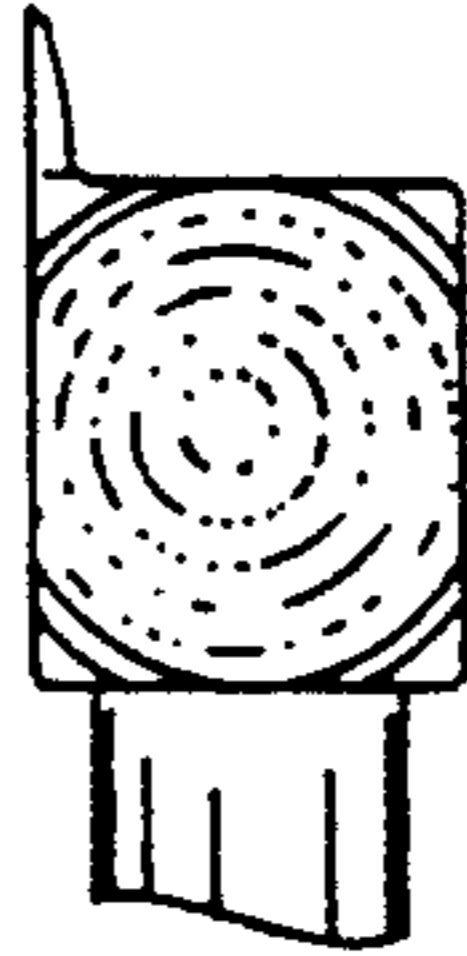

FIG. 4

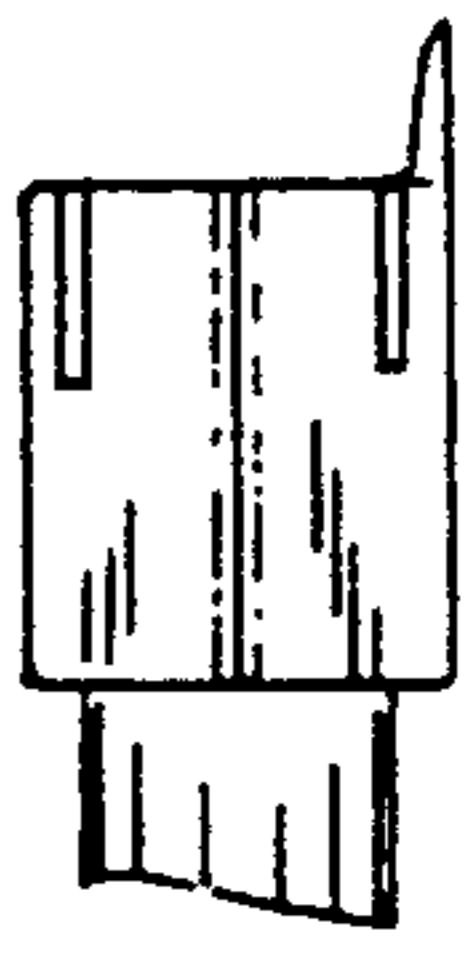

FIG. 5

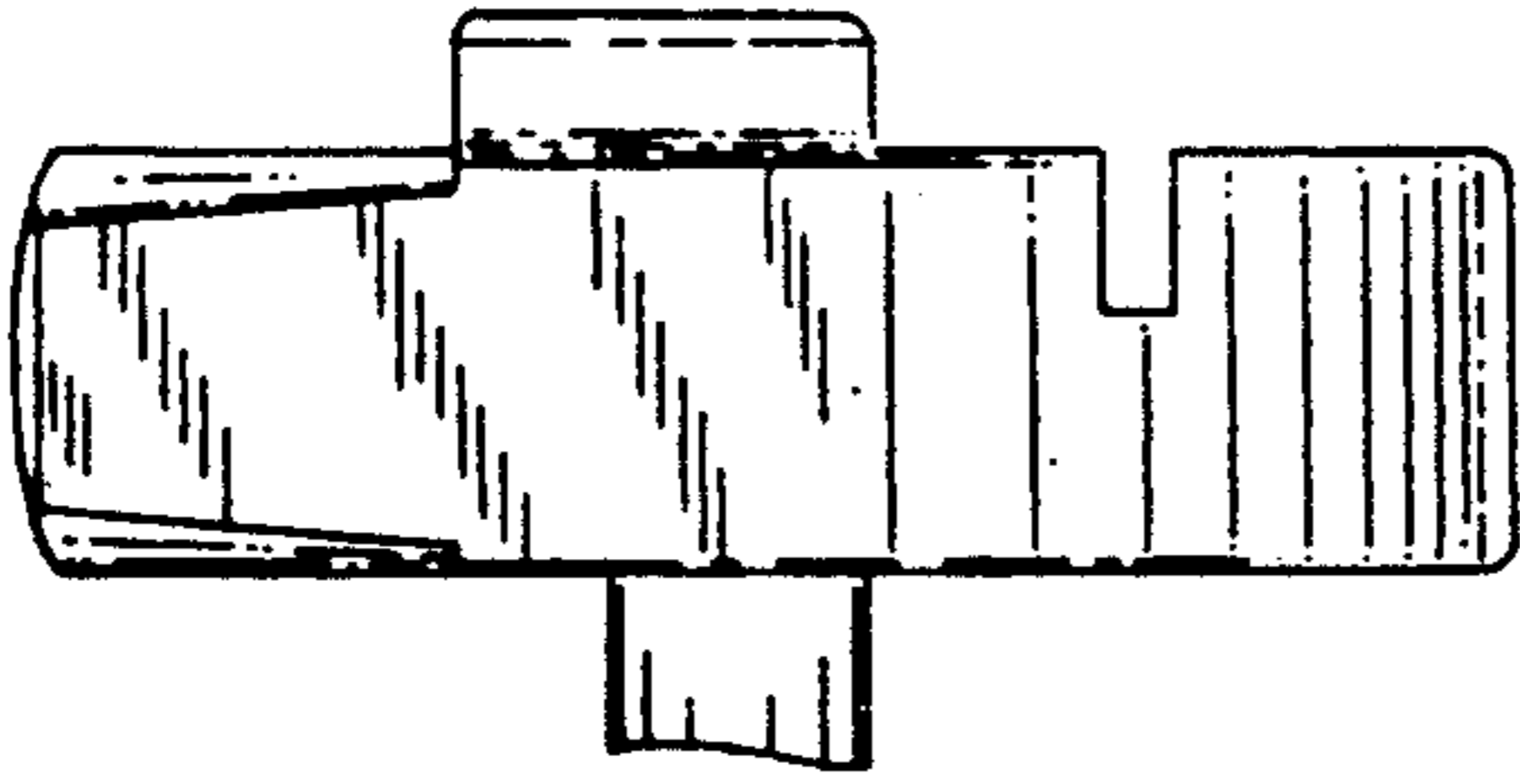

FIG. 2

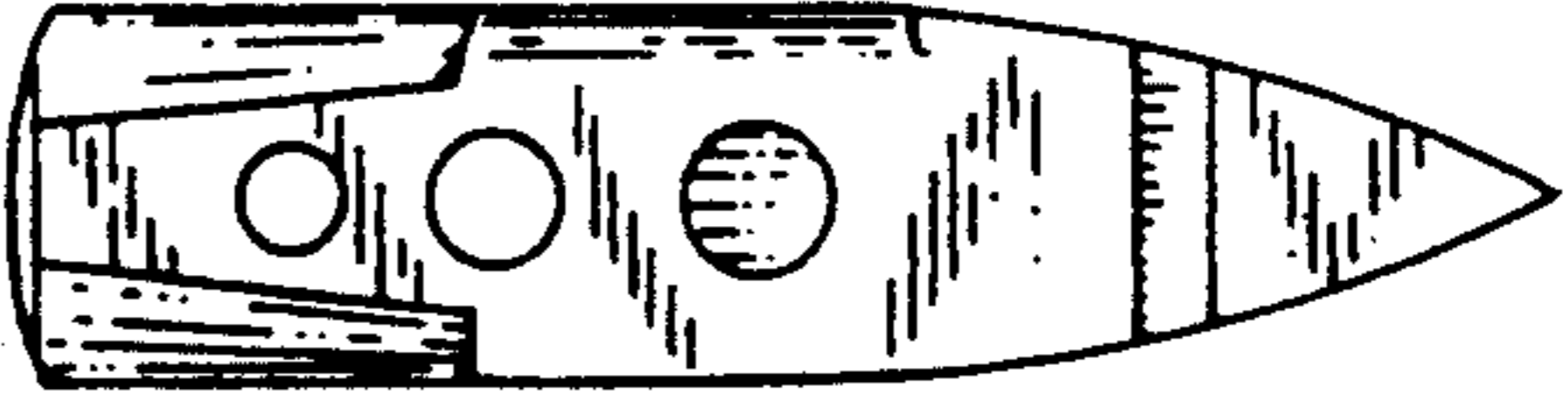

FIG. 6

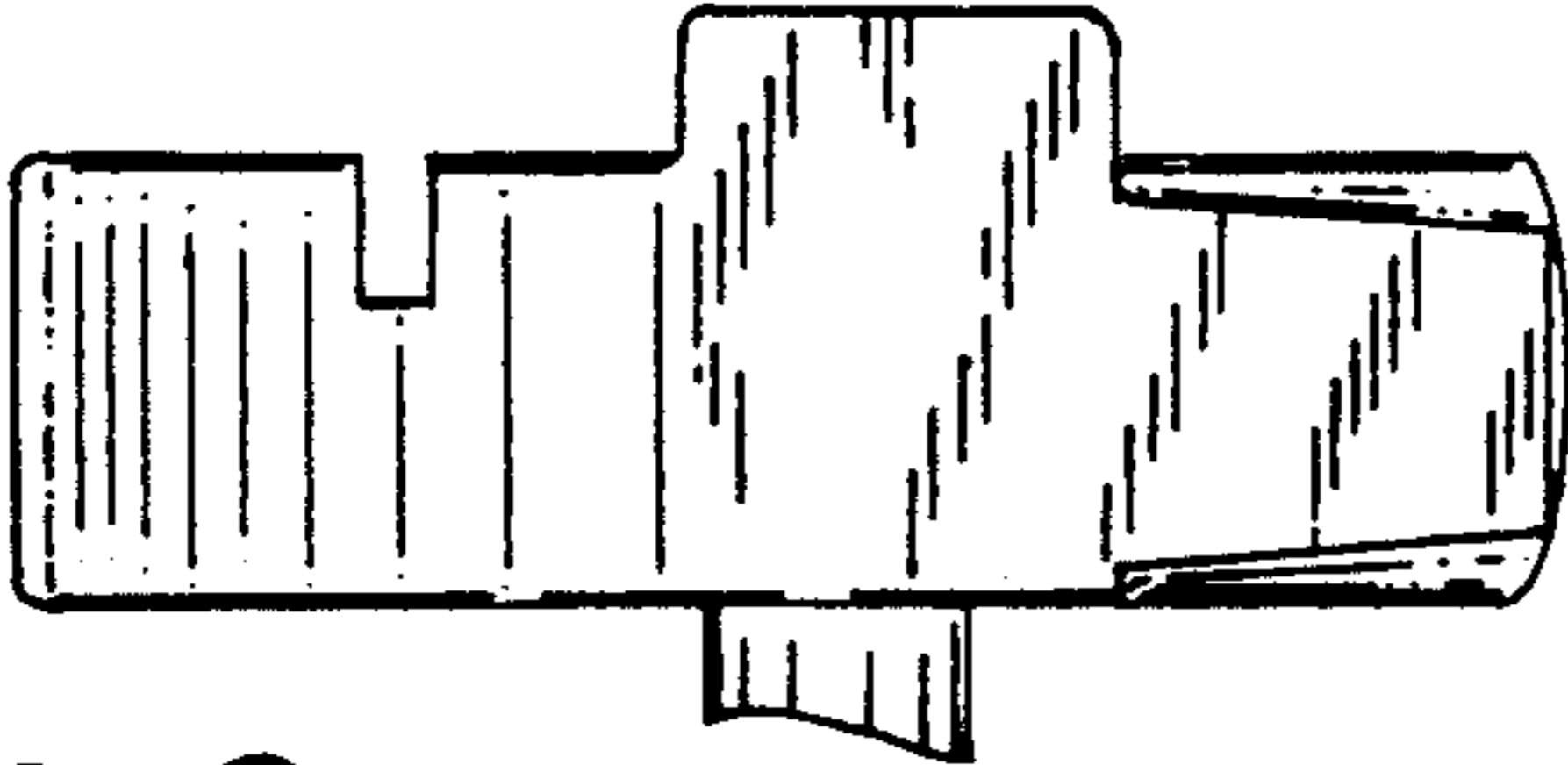

FIG. 3

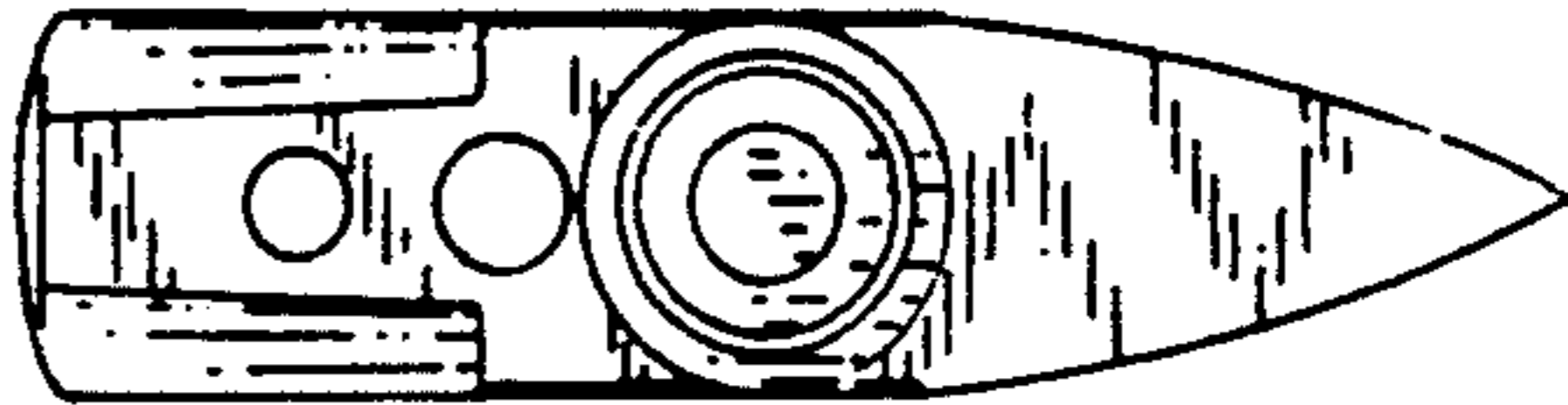

FIG. 7